

## INTRODUCTION

This Manual of Design and Specification Standards is the result of a charter initiated by the Deputy Vice President for Facilities, Robert W. Hatch, in November 1993. A task force was then created to establish a process to develop, implement and maintain the use of new University of Arizona Design and Specification Standards in the design, renovation and maintenance of all facility related projects. The task force completed this mission in June 1994 and established a Standing Oversight Committee to oversee the development and implementation of this new Manual.

The primary function of the Oversight Committee is to establish the authority under which the new Manual of Design and Specification Standards (DSS Manual) will operate. The Oversight Committee is to maintain a consistent decision making and operating philosophy that integrates the best interests of the UA Facilities Group and the current design and construction industries. The Oversight Committee performs this critical function by supervising the Technical Sub-Committees, approving all drafts of the DSS Manual and entertains all revision requests submitted.

The technical content of this manual represents the culmination of input from many Technical Sub-Committees who reviewed previous UA Standard Guidelines and integrated current needs and practices. Although it is felt that this effort produced a more up to date listing of UA Design and Specification Standards, it is realized that improvements are always possible and that many iterations may be required to achieve perfection. To pursue this goal a procedure has been formalized to continuously receive input an issue revisions to the Manual on a regular basis.

The most important aspect of this DSS Manual is the process to evaluate and implement revisions. Consequently your attention is directed to the Request for Revision Forms included in this manual. Without your continued and valued input the content of the Manual would stagnate.

Appreciation should be given to the following individuals for their participation as the Oversight Committee and their efforts in the development and compilation of this Manual.

Brian Dolan	Facilities Design and Construction
Carl Gajdorus	Facilities Design and Construction
Bob Herman	Facilities Management
Lionel Jacobs	Facilities Management
George McFerron	Facilities Design and Construction

Acknowledgments should also be given to all those who participated in the Technical Sub-Committees for without their efforts this Manual would not be possible.

---

Bob Smith, Director  
Facilities Design and Construction

---

Al Tarcola, Director  
Facilities Management

**MANUAL OF DESIGN AND SPECIFICATION STANDARDS**  
**REQUEST FOR REVISION**

Instructions:

1. Complete form in type written text or legible hand printing in black ink.
2. Be sure to include your name, department or firm and telephone number.
3. Provide as much justification for request as possible. Attach additional sheets if necessary and reference them on this form.
4. Please limit requests to one item or subject per form.
5. Mail completed form to:     DSS Oversight Committee  
  Attn: Brian Dolan  
  University of Arizona  
  Department of Facilities Design and Construction  
  1331 E. 5<sup>th</sup> St., Bldg. 49, Tucson, AZ 85721

Date: \_\_\_\_\_

From: \_\_\_\_\_

Telephone: \_\_\_\_\_

Please consider the following revision to the Manual of Design and Specification Standards. The nature of this request is (circle one):

Addition

Revision

Deletion

Section Number Reference: \_\_\_\_\_

Revision Requested (attach additional sheets if necessary):

---

---

---

---

---

---

Reason or Justification for Revision (attach additional sheets if necessary):

---

---

---

---

---

---

**TABLE OF CONTENTS**

(Δ = Rev 06/08)

**INTRODUCTION**

**REQUEST FOR REVISION FORMS**

**TAB A TABLE OF CONTENTS**

**TAB B PROCEDURES**

- Δ B-9 Record Drawings
- B-10 Variance Procedure
- Δ B-11 Surface Water Procedures (New Section)

**TAB C DESIGN CRITERIA**

- C-2 Campus Planning and Urban Design Guidelines
- Δ C-3 Laboratory Planning and Design
- C-5 Custodial Planning and Design
- C-6 Keyless Access and Security System
- Δ C-7 Room Numbering
- Δ C-9 Surface Water Design Guidelines
- C-11 Indoor Air Quality Criteria
- Δ C-12 Campus Accessibility (New Section)
- Δ C-13 Campus Sustainability (New Section)
- Δ C-14 Gender Neutral Restroom Requirements (New Section)

**TAB D BOILERPLATE**

DIVISION 00  
DIVISION 01

**TAB E STANDARDS**

DIVISION 02 - SITE WORK

- Section 02100 Demolition
- Section 02200 Earthwork
- Section 02280 Soil Treatment
- Section 02500 Paving and Surfacing
- Δ Section 02610 Site Chilled Water & Heating Water Utilities (New Section)
- Δ Section 02620 Site Potable Water & Reclaimed Water Utilities (New Section)
- Δ Section 02640 Site Natural Gas Utility (New Section)

- △ Section 02710 Site Sanitary Drainage (New Section)
  - △ Section 02720 Site Storm Drainage (New Section)
  - △ Section 02810 Irrigation
  - Section 02830 Fences and Gates
  - Section 02850 Trash Compactor Embed Plan
  - Section 02870 Site and Street Furnishings
  - △ Section 02900 Landscaping
- DIVISION 03 - CONCRETE
- △ Section 03310 Structural Concrete
  - Section 03330 Architectural Concrete
- DIVISION 04 - MASONRY
- △ Section 04200 Unit Masonry
- DIVISION 05 - METALS
- Section 05300 Metal Decking
  - △ Section 05500 Metal Fabrications
  - △ Section 05700 Ornamental Metals- Skateboard Deterrents (New Section)
- DIVISION 06 - WOOD & PLASTICS
- Section 06000 General Discussion
  - Section 06100 Rough Carpentry
  - Section 06170 Prefabricated Structural Wood
  - Section 06200 Finish Carpentry
  - Section 06402 Architectural Woodwork
- DIVISION 07 - THERMAL & MOSITURE PROTECTION
- Section 07000 General Discussion
  - Section 07100 Waterproofing and Dampproofing
  - △ Section 07200 Insulation
  - Section 07240 Exterior Insulation and Finish Systems
  - Section 07250 Fireproofing
  - Section 07270 Firestopping
  - Section 07310 Shingles
  - Section 07320 Roofing Tiles

Section 07410 Preformed Roof and Wall Panels

Δ Section 07500 Membrane Roofing

Section 07570 Traffic Topping

Section 07590 Horizontal Traffic Surfacing

Section 07600 Flashing and Sheet Metal

Section 07700 Roof Specialties and Accessories

Section 07800 Skylights

Section 07900 Joint Sealers

#### DIVISION 08 - DOORS & WINDOWS

Section 08000 General Discussion

Section 08110 Steel Doors and Frames

Δ Section 08210 Wood Doors

Section 08305 Access Doors

Section 08330 Overhead Coiling Doors

Section 08400 Entrances and Storefronts

Section 08500 Metal Windows

Section 08610 Wood Windows

Δ Section 08710 Finish Hardware

Δ Section 08711 Finish Hardware; Residence Life (New Section)

Section 08720 Automatic Door Operators

Δ Section 08800 Glazing

#### DIVISION 09 - FINISHES

Section 09000 General Discussion

Δ Section 09100 Metal Support Systems

Section 09200 Lath and Plaster

Section 09250 Gypsum Board

Δ Section 09330 Tile

Section 09500 Acoustical Treatment

Section 09650 Resilient Flooring

Δ Section 09680 Carpet and Carpet Tile

Section 09900 Painting

Section 09950 Wall Covering

DIVISION 10 - SPECIALTIES

- Section 10000 General Discussion
- Section 10100 Markerboards and Tackboards
- Section 10160 Toilet Compartments
- Section 10260 Wall and Corner Guards
- △ Section 10293 Bird Control (New Section)
- Section 10410 Directories and Bulletin Boards
- △ Section 10420 Dedication Plaque
- Section 10430 Exterior Signs
- Section 10520 Fire Protection Devices
- △ Section 10810 Toilet Accessories

DIVISION 11 - EQUIPMENT

- Section 11050 Compact Shelving
- Section 11132 Projection Screens

DIVISION 12 - FURNISHINGS

- Section 12000 General Discussion
- △ Section 12345 Laboratory Casework
- Section 12510 Blinds
- Section 12690 Floor Mats and Frames
- Section 12710 Fixed Seating

DIVISION 14 - CONVEYING SYSTEMS

- △ Section 14000 General Discussion
- △ Section 14210 Electric Traction Elevators
- △ Section 14240 Hydraulic Elevators
- Section 14440 Conveying Systems

DIVISION 15 - MECHANICAL

- △ Section 15000 General Discussion
- △ Section 15050 Basic Mechanical Materials and Methods
- △ Section 15250 Mechanical Insulation
- △ Section 15300 Fire Protection
- △ Section 15410 Plumbing Piping
- △ Section 15440 Plumbing Fixtures

- Δ Section 15450 Plumbing Equipment
- Δ Section 15480 Plumbing Special Systems
- Δ Section 15510 Hydronic Piping and Specialties
- Δ Section 15520 Steam Piping and Specialties
- Δ Section 15530 Refrigerant Piping and Specialties
- Δ Section 15540 HVAC Pumps
- Δ Section 15550 Heat Generation
- Δ Section 15680 Water Chillers
- Δ Section 15780 Packaged Air Conditioners
- Δ Section 15810 Humidifiers
- Δ Section 15840 Ductwork
- Δ Section 15850 Ductwork Accessories
- Section 15855 Air Handling Units With Coils
- Section 15860 Centrifugal Fans
- Δ Section 15870 Variable Frequency Drives (New Section)
- Section 15970 Control Systems
- Δ Section 15980 Utility Meters
- Section 15990 Testing, Adjusting and Balancing

DIVISION 16 – ELECTRICAL

- Δ Section 16000 General Discussion
- Δ Section 16050 Basic Electrical Materials and Methods
- Δ Section 16110 Raceways
- Δ Section 16115 Underground Distribution
- Section 16120 Wire and Cable
- Δ Section 16122 Primary Power Cables
- Section 16130 Boxes
- Δ Section 16140 Devices
- Section 16160 Cabinets and Enclosures
- Section 16170 Circuit and Motor Starters
- Δ Section 16175 Elevator Power and Controls
- Section 16190 Supporting Devices

	Section 16195	Electrical Identification
Δ	Section 16310	Primary Switching Station
Δ	Section 16320	Transformers (High Voltage)
	Section 16390	Primary Grounding
	Section 16420	Service Entrances
Δ	Section 16425	Motor Control Centers, Controllers and Contractors
Δ	Section 16430	Metering
Δ	Section 16435	Switchboards
	Section 16440	Disconnect Switches
	Section 16450	Secondary Grounding
Δ	Section 16460	Transformers (Low Voltage)
Δ	Section 16465	Busduct
Δ	Section 16470	Panelboards
Δ	Section 16475	Overcurrent Protective Devices
	Section 16485	Lighting Controls and Contactors
Δ	Section 16510	Lighting Design
	Section 16530	Site Lighting
Δ	Section 16535	Emergency Lighting
Δ	Section 16580	Theatrical Lighting
	Section 16610	Uninterruptable Power Supply Systems
	Section 16620	Standby Power Generator Systems
	Section 16622	Automatic Transfer Switch
Δ	Section 16650	Electromagnetic Shielding Systems
Δ	Section 16660	Ground Fault Protection Systems
Δ	Section 16680	Variable Speed Drive Systems
Δ	Section 16700	Telecommunications
Δ	Section 16705	Blue Light Phones (New Section)
	Section 16720	Fire Alarm Systems
	Section 16730	Clock and Program Systems
Δ	Section 16950	Testing

## APPENDIX

### ELECTRICAL SUPPLEMENTAL SPECIFICATIONS



- Δ Section 16122 Primary Power Cable
- Δ Section 16310 Primary Switch Station
- Section 16320 Pad Mount Transformer
- Δ Section 16425 Motor Control Centers (New Section)
- Δ Section 16435 Switchboards
- Δ Section 16620 Natural Gas Engine Generator Set
- Δ Section 16621 Automatic Transfer Switch (New Section)
- Δ Section 16622 Automatic Transfer Switch, Bypass Isolation Type
- Δ Section 16720 Fire Alarm Systems

## TAB B-9

### RECORD DRAWINGS

Project record drawings and shall be prepared for all University of Arizona projects. The concept "Record Drawings" shall replace what has previously been called "As-Builts".

During construction the Contractor shall maintain a clean set of project drawings to record all as-built and record information. This information shall be kept current and in accordance with the requirements of Division 01300. The UA may additionally require that every month, as a condition for progress payment, the Contractor shall print a set of bluelines for review and to insure that the as-builts are being maintained and the updated information is accurate, clear and legible.

At the end of construction the Contractor will give to the Architect/Engineer the updated mylars or the marked up original as-built drawings with each sheet clearly stamped "as-built," signed and dated. The Consultant will then transfer this information to a new set of reproducible mylars. In addition the Consultant will incorporate any other revised information provided during the course of construction. (RFI's, ASI's, RFP's etc.) that may be missing from the Contractor's set of drawings.

Whenever possible changes should be incorporated into the drawings by striking through the original information, entering the new information, referencing the change to the initiating document and flagging/keynoting the revision to "Record Drawings". It is also desirable to include a brief description of the nature of the change when appropriate (i.e., waterproofing added, outlets revised, etc.).

Where the original drawings were produced using AutoCADD the record drawings should also be produced in AutoCADD. Coordinate with UA project manager/facilities project manager for specific formatting requirements of electronic files.

It is realized that Record Drawings produced with AutoCADD will not be sealed as the original construction documents were.

Every drawing sheet shall contain somewhere a large (3/4" x 2") block stating "RECORD DRAWINGS" and the submittal date. In addition, the revision title block listing shall show as its last entry the date of the record drawing submittal and referenced accordingly. The date for every sheet within the complete set shall be the same.

Where contractor furnished shop drawings would be of value for the archival record drawings, they shall be pasted up on a blank title block sheet and/or scanned into an AutoCADD file. Examples of beneficial drawings are fire sprinkler, fire alarm, telecom, EMCS shop drawings and mechanical coordination drawings. These additional sheets can be reduced to facilitate posting on the standard title block sheet. Place a prominent note indicating the origin of the drawing. Create an appropriate sheet numbering scheme and update the drawing index accordingly.

Completed Record Drawing mylars (or paper copies) and electronic drawing files in both Auto CADD and pdf formats are then forwarded to FDC for archiving. A set of drawing copies and/or a copy of the electronic drawing files are sent to FM Engineering for their use and reference.

## TAB B-10 VARIANCE PROCEDURE

It is realized that there will be project specific instances where a variance to the specification standards contained with in Tab E of the UA DSS Manual may be desired and/or warranted. Any party to a project may initiate a variance by completing a Request for Variance form and submitting it to the Project Manager for consideration. The process for evaluating the variance item is prescribed by the following flow chart. Variances are only considered on a case by case basis and do not constitute a wholesale revision to the DSS Manual.

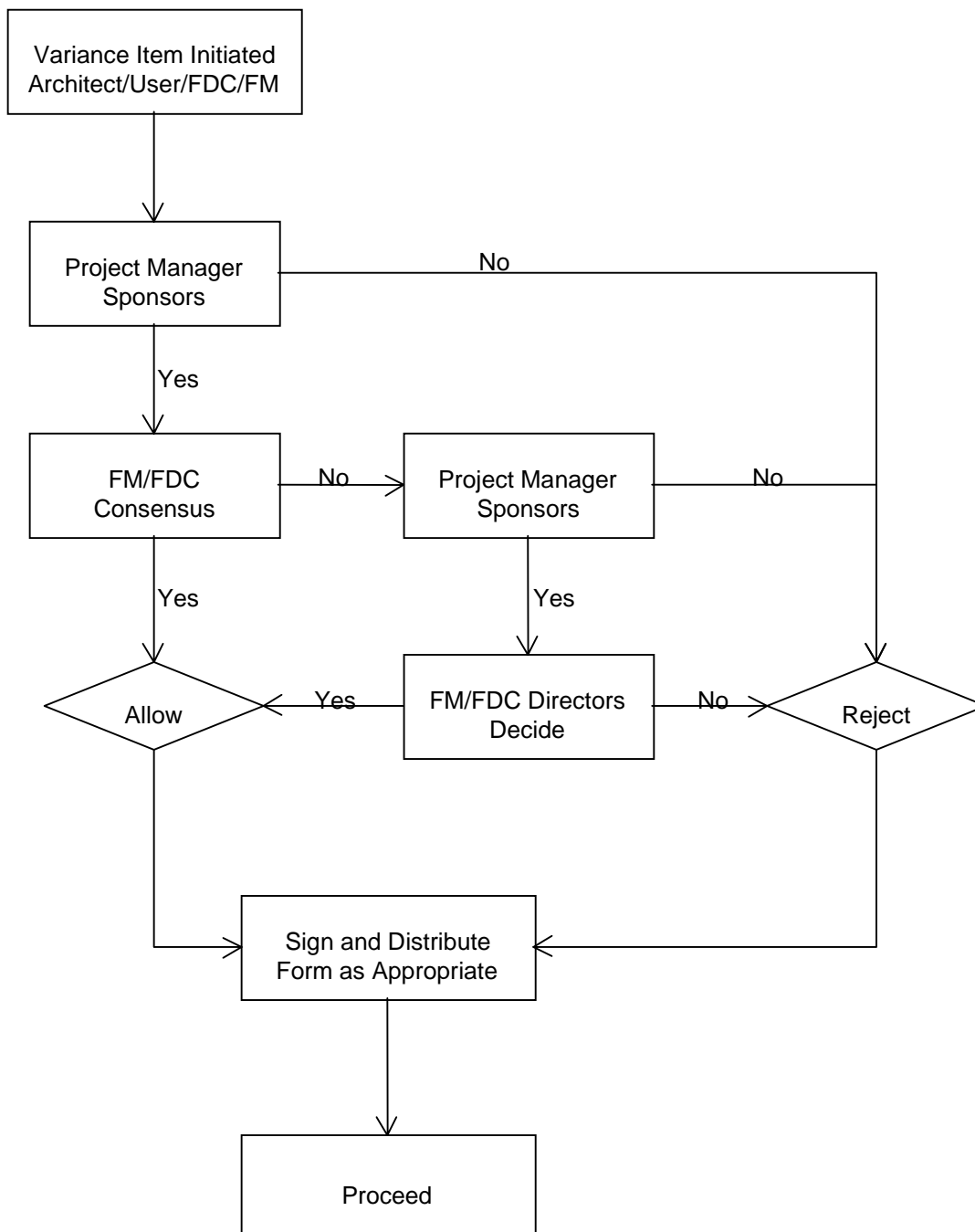

**MANUAL OF DESIGN AND SPECIFICATION STANDARDS**  
**REQUEST FOR VARIANCE**

Introduction:

The University of Arizona desires to utilize the Design and Specification Standards without exception or variance. Special conditions may arise, however, where a variance is needed or justified. No variance from Design and Specification Standards will be allowed without prior approval indicated on a Request for Variance Form.

Instructions:

1. Complete form in type written text or legible hand printing in black ink.
2. Be sure to include your name, department or firm and telephone number.
3. Provide as much justification for request as possible. Attach additional sheets if necessary and reference them on this form.
4. Please limit requests to one item or subject per form.
5. Deliver or fax completed form to the FDC Project Manager.

Date: \_\_\_\_\_

From: \_\_\_\_\_  
\_\_\_\_\_

Telephone: \_\_\_\_\_  
Fax No. : \_\_\_\_\_

Please consider the following variance from the Manual of Design and Specification Standards.

Project Name: \_\_\_\_\_ Project No.: \_\_\_\_\_

Section Number Reference: \_\_\_\_\_

Variance Requested (attach additional sheets if necessary):

\_\_\_\_\_  
\_\_\_\_\_  
\_\_\_\_\_

Reason or Justification for Variance (attach additional sheets if necessary): \_\_\_\_\_

\_\_\_\_\_  
\_\_\_\_\_

This Request for Variance is \_\_\_\_\_ Approved \_\_\_\_\_ Not Approved.

Reasoning: \_\_\_\_\_

By: \_\_\_\_\_ Date: \_\_\_\_\_

Facilities Design and Construction

Distribution: \_\_\_\_\_

## TAB B-11

### SURFACE WATER PROCEDURES

#### 1. Prior to Retaining the Design Professional:

Depending on the nature of the project and site, an independent surface water study (as a precursor to the surface Water Report described below) may be required and completed prior to the start of the project for the purpose of understanding site issues, budgeting, or other needs.

#### 2. Project Design Process:

The Design Professional's scope of work will require compliance with the surface water standards found in **TAB-C** and **TAB-E** of this Manual of Design & Specification Standards. As a result of project specific design guidelines identified in the independent surface water study above, surface water requirements may be developed which call for unique surface water features or other special requirements. The *University of Arizona Surface Water Working Group* will be available to review these standards and guidelines with the Design Professional.

The project design should be informed by the most current university comprehensive campus drainage study, project specific site development guidelines, The *University of Arizona Manual of Design and Specification Standards*, site soils tests, and other regulatory considerations. These resources shall guide the preparation of a *Surface Water Report* and design solutions, as required in the project scope of work and described in ~~#3~~ below. The *University of Arizona Surface Water Working Group* is available to the Design Professional throughout the project to discuss and provide guidance on detailed surface water design solutions.

The Design Professional is responsible for insuring that all applicable sub-consultants understand the studies, plan sets, details, and specifications each sub-consultant will need to prepare in order to meet these standards. Sub-consultant fees should appropriately reflect the work necessary to meet these standards.

During the first design stage where site development concepts are being investigated there should be a demonstration of how existing drainage impacts the site along with conceptual options for how surface water may become an integral part of the project design. At each subsequent plan review phase the submittal set shall include designed surface water elements which are responsive to the *Concepts and Mitigation* section of the *Surface Water Report* described below and are developed to a level of design commensurate with the rest of the project.

Appropriate soils tests will be completed as early in the design process as possible to inform the final surface water design solutions. These tests shall include measures needed to understand the suitability of the soil for the infiltration needed for retention/detention, in addition to structural and other characteristics.

#### 3. Surface Water Report

During the first design stage where site development concepts are being investigated, a draft *Surface Water Report* will be prepared by the Design Professional. The report will have two main components: an *Existing Conditions Analysis* section, and a *Concepts and Mitigation* section.

*Existing Conditions Analysis:* this report section analyzes and documents existing surface water conditions on the project site. The form and methods used for this report should conform in general to City of Tucson standards, e.g., use the format of the City's "Standards Manual for Drainage Design and Floodplain Management in Tucson" to create a Drainage Statement, Hydrology Report, or a Drainage Report. Technical analyses shall be built on the University's most recent Comprehensive Campus Drainage Study hydrology model.

*Concepts and Mitigation:* each subsequent draft of this report section should include increasing specificity and technical documentation on proposed surface water features and mitigation which emerge

from the initial vision/concepts. This report section shall include, at a minimum, the following two elements:

- Surface water vision and concepts for the project, presented in narrative and graphic form, conveying how surface water may be incorporated in the project design. Evaluation of required, recommended, and anticipated surface water features shall be included, along with topics such as defining finished floor elevations relative to flood levels and evaluating other surface water sources in the vicinity for potential use within the project site. The final Report shall include a water budget for the proposed landscape, including an analysis of water sources available to meet the budget. Proposed concepts and features shall come from a collaborative process involving all applicable team members. At a minimum this should include the project's Landscape Architect, Civil Engineer, and the Project Architect.
- Assessment of anticipated surface water impacts of the project on the surrounding area (the site proper and at least ¼ mile beyond the site limits) and likely mitigation needed. Maps should indicate how the site/project interfaces with its own and adjacent watersheds.

#### **4. Surface Water Report Submittals**

Each draft of the *Surface Water Report* will be reviewed by departments represented on the *University of Arizona Surface Water Working Group*. Another copy will be provided to the University of Arizona for transmittal to the City of Tucson stormwater section staff for their review. This is considered a courtesy review, although upon evaluation of City of Tucson comments, the University of Arizona may request such comments be incorporated into the design plans. Following is a summary of each report draft:

- First Draft: The first draft of the *Surface Water Report* shall be included with the project's first concept design submittal. The surface water conditions, concepts, features, and mitigation described within the report are to be included in the presentation to PADRAC. All subsequent PADRAC project presentations and submittal sets shall include these surface water elements developed to a level of design commensurate with the rest of the project.
- Second Draft: A second draft of the *Surface Water Report* shall be due with the schematic design submittal set. This draft shall include updated/refined graphic and narrative descriptions of surface water concepts, features, and mitigation.
- Final Report: The final version of the *Surface Water Report* shall be submitted with the construction document submittal and will include updated modeling and analysis of designed features and mitigation. An executive summary is to be provided which includes, among other information, a statement from the project Civil Engineer noting in both technical and layman's terms ways in which the project design varies from and/or meets City of Tucson standards.

## TAB C-2

### CAMPUS PLANNING AND URBAN DESIGN GUIDELINES

#### PROJECT-SPECIFIC

The Department of Campus and Facilities Planning (CFP) will provide urban planning input on facility design projects in the followings ways:

- Capital Projects
  - In coordination with Facilities Design and Construction (FDC), CFP will develop Design Guidelines for the project (e.g., massing, circulation, setbacks, etc.) and will review the project for consistency with the Comprehensive Campus plan, and/or any other applicable subarea or functional plans.
- Non-capital Projects
  - CFP will offer design input and interpretation of campus plans to A/E Consultants and FDC, but will not prepare Design Guidelines specifically for the project.

#### GENERAL

- The following guidelines have been derived from the University's adopted Comprehensive Campus Plan (CCP), and briefly summarize guidelines for the development of the campus, particularly where visual quality and urban design issues area concerned. Additional background on these guidelines can be found in the CCP Review Draft and Technical Background document, which is available at CFP. The Comprehensive Plan summary document may be viewed on the internet at: <http://w3.arizona.edu/~cfp/ccp/ccp.htm>

- The goal for campus aesthetics is to:

**ESTABLISH A SENSE OF AESTHETIC CONTINUITY CAMPUS-WIDE, BY DEVELOPING AND UTILIZING DESIGN VOCABULARIES AND GUIDELINES IN THE PRESERVATION AND REUSE OF EXISTING STRUCTURES AND OPEN SPACE AREAS, AS WELL AS IN THE DESIGN OF NEW FACILITIES AND OPEN SPACES.**

- It should be noted that visual quality concerns cannot be entirely separated from Development and Infrastructure Guidelines, and that, in fact, both aesthetic and functional considerations are operative in any planning and design activity for the campus. These guidelines primarily focus, however, on the visual quality of the outdoor environment, including buildings and other structures, open spaces, and circulation routes.

#### BUILDINGS AND FACILITIES

- The guidelines outlined below should be employed in designing new buildings and facilities, and in reuse of and/or additions to existing buildings and facilities.
  - Orientation/Placement of Building On-site
    - The following considerations should be addressed in building siting and design: views, circulation, open space, on-site parking, future expansion, microclimate, and existing site features.

- Indoor-Outdoor Relationships
  - A more active relationship between interior and exterior space than has occurred in most existing facilities is a goal in the siting and design of new buildings and additions. This relationship is sought not only on the ground plane, but at other building levels as well.
- Scale and Massing
  - New facilities are generally becoming increasingly large and bulky. At the same time, these buildings must be compatible with existing buildings often at a smaller scale, and must be humanly scaled at the pedestrian level(s).
- Architectural Style
  - Within the Historic District, all new construction should be as compatible as possible with existing historic structures. This includes overall massing, fenestration, brickwork, and architectural detailing. The State of Arizona Historic Preservation Office will consult in any reuse of and additions to structures listed on the National Register.
  - In predominantly built-up areas already existing on campus, new construction should be architecturally compatible with the existing structures. While contemporary architectural styling is anticipated, appropriate massing, building materials, and detailing should contribute to a sense of visual unity.  
*Example: Pharmacy Building*
  - In new areas of campus development, (such as between Speedway and Mabel, and Sixth and Eighth Streets), a high standard of contemporary architectural excellence is required. The prevailing desert climate should have a major impact on architectural style.
- Building Materials
  - The selection of exterior building materials for permanent facilities should be based on long-term institutional durability and ease of maintenance; texture and textural variety; color palette; energy conservation considerations; cost and availability; and type and use of structure.
- Artwork and Graphics
  - Works of art should be integrated into the design of each building, especially in building entrance areas (indoor and outdoor) and other high-use common areas. This may include sculpture, murals, architectural relief, and/or pavement patterning.
- Strategic Buildings
  - Gateway buildings anchor strategic street intersections which mark entrances to the campus from public arterial streets. A gateway building functions as a highly visible facility, which structures the aesthetic experience of motorists in the vicinity of the gateway. In addition, the building is key to creating an identifiable campus area for the portion of campus with which it is associated. Particular care should be given to the siting of a gateway building in relation to its intersection, as well as to building design, landscaping, and lighting.
  - Landmark buildings anchor activity nodes or major open space areas. A landmark building is designed to be easily identifiable or visually significant, especially to pedestrians, because of its clear or unique form or massing; high figure - background contrast due to siting, scale, color, or architectural style; and/or its prominent spatial location. Special attention should be given to building design and massing, landscaping, and lighting. New landmark buildings should be designed to actively structure and enhance the usable open space they anchor. *Example: Old Main at Main Mall.*



- Parking Structures and Decks
  - The design guidelines for building and facilities set out above generally apply.
  - Because of the massiveness of parking structures, special consideration should be given to building materials, detailing, and landscaping.
  - Safety and security should be a primary design consideration, including the location and visibility of vertical circulation, night lighting, and graphics.

## CAMPUS OPEN SPACE

- This section summarizes the guidelines which provide the basis for the design and review of landscaping and open space development plans. This is critical to achieving an overall campus character.
- Overall Character - three typical conditions arise, each calling for a distinct design treatment.
  - For malls and corridor-type open spaces (usually involving street closures), as well as formal campus entrances: Refined, formal arrangement of landscape elements (plantings, seating, lighting, pavement treatment, and so on); characterized by predominantly symmetrical pattern and use of repeated elements. *Existing example: Main Mall. Proposed example: Highland Corridor*
  - For transition zones and campus gateways - informal arrangements of landscape elements, either in continuous meandering pattern for linear conditions, or clustered or grove-like pattern for entry/highlight conditions. *Existing example: Park Avenue Buffer. Proposed example: Speedway Boulevard landscaping treatment*
  - For intensively used plaza areas (activity nodes) - utilization of formal, repeated or patterned elements to identify major pathways and building entrances; in combination with informal patterns for seating and other usable open space areas. Introduction of level changes, usable lawn areas, and a variety of hard surfaces is encouraged. *Existing example: "Education Plaza". Proposed Examples: Sciences Concourse, Regents Square*
- View Preservation – the predominant approach recommended in these guidelines is the creation and preservation of vistas into and within the campus, rather than outward toward the mountains.
  - Major vistas along campus streets and open space areas - these provide a linear view for pedestrians, visually organizing the open space and orienting the user; they also provide open space views from buildings facing the open space. *Existing example: Main Mall. Proposed example: Cherry Corridor*
  - View "windows" from arterial streets into campus - these include "windows" created by major openings between buildings (including widenings of open space corridors) and the two formal campus entrances along Campbell Avenue. *Existing example: A.H.S.C. Entrance. Proposed example: Olive-Fremont Windows on Speedway Boulevard*
- Animation - to insure adequate animation of activity nodes and open space corridors, the following guidelines apply:
  - A variety of usable open spaces accommodating a range of activities is desirable.
  - For any open space, at least three types of seating should be provided.
  - Uses which draw people and people-watchers should be incorporated.
  - The use of participatory artworks and well designed water features is encouraged.
  - Major pedestrian routes should be incorporated.
  - Bicycle routes and/or major bicycle parking areas should be included.
  - Design elements should be employed to add color and festivity, and thus attract use.

- Development at multiple levels -- such as sunken plazas, under-and overpasses, mezzanines, balconies, and arcades -- is desirable to encourage people-watching, as well as to provide visual interest.
- Visual Continuity - the design elements in open space development include planting materials; seating; surface treatments; lighting; special features such as food pavilions, transit stops, and information kiosks; artwork; and associated buildings. Certain elements should be consistently employed on a campus-wide basis to provide visual continuity, harmony, and legibility:
  - Palette of theme plantings for repeated use, in particular canopy trees lining pedestrian and bicycle paths.
  - Common building materials and colors for campus architecture.
  - Comprehensive campus signage and graphics system. (Refer to UofA Sign Committee & 2/97 Signage Standards.)
  - Common surface treatments of pedestrian and bicycle paths.
  - Common lighting fixtures and supports.
  - For existing open spaces undergoing redevelopment, existing elements will be utilized to the extent possible. For new spaces, an overall character should be established which will be used as each new building and associated open areas are developed.
- Crime Preventive Design - the principles of crime preventive design and defensible space should be utilized in the planning and design of outdoor space, particularly for major pedestrian paths and usable open spaces. This means design which discourages criminal activity and encourages visual surveillance by campus users as well as campus police and security.
  - Sufficient night lighting must be provided along major pedestrian routes, in activity nodes, in parking areas and structures, and at major building entrances. The installation of emergency telephones in strategic locations should also be considered.
  - Landscaping and walls should be designed to maintain visibility between heavily trafficked areas, and not as screens for potential intruders.
  - Where possible, elevation differences, view "windows," and vistas should be used to encourage surveillance between intensely used pedestrian areas, and between pedestrian areas and well trafficked streets.
  - Design which encourages development of identifiable open space "territories" with which people associate themselves and neighboring users, is desirable. This is especially appropriate in campus residential communities.
- Screening – shall consist of screen plantings, walls or fences, berms or elevation differentials, or a combination of these measures. For most situations, screening should be a minimum of five feet in height. The following new facilities should be screened from view:
  - trash collection areas
  - delivery/loading areas
  - outdoor storage areas
  - major above grade utility installations
  - most surface parking lots
- Landscaping - at the outset of design of any facility or open space, a thorough site survey should locate and identify all existing on-site plantings. Healthy specimen trees and palms should be preserved "in situ" to the extent possible. If this is not possible, relocation should be considered in preference to demolition. A theme plant palette should be established, listing plants for repeated use on campus to further establish a sense of landscaping consistency. The following characteristics are desirable for plantings on campus:
  - low water requirements/drought tolerant;
  - non-allergenic;

- ease of maintenance -- preference for non-deciduous species dropping no fruit, clean species requiring little pruning;
  - non-invasive root systems;
  - pest and disease resistant.
  - There are certain exceptions to all of the above, depending on location, use, and historical value.
- Barrier Free Design - pedestrian routes and usable open spaces should be designed and landscaped to permit access and use by physically handicapped persons. Buildings, parking facilities and grade-separated crossings must be accessible to the physically disabled as well.
  - Campus Legibility - equally important as campus signage in orienting people is the "legibility" of the campus -- the capacity of the campus to provide users visual clues as to their location and direction of movement. A number of proposals embodied in the Plan are designed to enhance and augment the legibility of the campus for both the campus community and visitors:
    - Creation of distinct development use clusters or districts.
    - Redevelopment and development of identifiable activity nodes of usable open space (plazas, malls).
    - Use of landmark buildings to further distinguish activity nodes.
    - Further development of transition zones which provide a distinct campus edge along arterial streets and planning area boundaries.
    - Creation of campus gateways, in part defined by gateway buildings.
    - Enhancement and development of linear pedestrian corridors, most with major vistas to be preserved.
    - Use of campus theme plantings and campus color and materials palettes to provide a consistent, coherent "background" for special features (above).
    - Preservation of the historic district and wall of the campus.

#### CAMPUS TRANSITION ZONES

- The goal for University interfaces with non-University uses is as follows:

##### TREAT FUNCTIONAL AND AESTHETIC INTERFACES WITH NEIGHBORING COMMERCIAL AND RESIDENTIAL AREAS AND WITH CITY STREETS AS SENSITIVELY AS POSSIBLE.

- Arterial Streets - the following generally summarizes the guidelines applicable to city arterial streets. The purpose of the guidelines is to provide a high quality visual experience to motorists passing the University, as well as to cooperate with the city in maximizing the safety and efficiency of arterial streets. Treatment of the arterial street "transition zone" is incorporated into these guidelines.
  - Building design:
    - Limit building heights in proximity to the street to 4 to 5 stories. Step back any structures immediately adjacent to street if possible.
    - Present a pleasant facade to the street, not an apparent "backside" of the building.
  - Street treatment:
    - Provide a continuous landscaped buffer along the street, retaining a sidewalk parallel to but not necessarily abutting the roadway.
    - Further develop the existing landscaping pattern, if any, or establish a new pattern.
    - Accommodate underground utilities.
    - Encourage city to retain or install landscaped median.
    - Provide directional graphics as needed.
  - Visual access:
    - Retain formal campus entrances.

- Provide designated campus gateways.
- Develop the proposed "windows" into the campus.
  
- Auto circulation:
  - Close local streets as proposed in a timely manner, in cooperation with the city and adjacent neighborhoods.
  - Encourage Suntran to provide service at transit stops and terminals.
  - Work with the city in the design of arterial street widenings, grade-separated pedestrian/bicycle crossings, University parking structures, and intersection signalizations.
  
- Neighborhood Interface - in the Comprehensive Campus Plan, transition zones or buffers are indicated along the campus planning area boundary, adjacent to local streets and neighborhoods. These guidelines apply to the treatment of the transition zone or buffer, providing as sensitive a relationship by the campus to its neighbors as possible.
  
- Timing
  - Recognize that development can occur at the current edge of the campus, versus at the campus boundary at full build-out. Therefore, some development may appear intrusive or insensitive to neighbors during the interim period. There also may be awkward circulation patterns on a temporary basis.
  - Screen new parking lots designated "permanent" or to be in place more than three years, with landscaping and/or walls or fences.
  - Implement the continuous buffer treatment (see below) as opportunities arise.
  
- Uses
  - Place uses at the planning area boundary which are as compatible as possible with neighboring uses.
  - Maintain uses to a standard that is consistent with and will not detract from the overall appearance of the neighborhood.
  - The most appropriate uses are day-time oriented, creating no nuisances or disruption to neighbors, in particular the location of greenhouses in a "precinct" in the southwest quadrant of campus at Eighth Street and Park Avenue. *Examples:* office uses, research facilities with no unusual noise or radiation concerns, such as greenhouses.
  - Adult or graduate student housing is preferred to undergraduate housing.
  - Recreational facilities are appropriate if spillover noise and lighting can be controlled or night use limited to specified hours, and/or public neighborhood usage provided.
  
- Mitigation of Possible Nuisances - the following are potential nuisances to neighbors, and should be mitigated to the extent possible during design:
  - Auto traffic volume and noise (see below).
  - Street parking (see below).
  - Spillover lighting.
  - Spillover noise.
  - Pedestrian traffic in high volumes.
  - Night usage.
  - Fumes or odors.
  - Shadow patterns (solar accessibility).
  - Run-off/drainage.
  - Criminal activity and vandalism.

- Auto Circulation and Parking
  - Provide routes internal to the campus to accommodate most University traffic.
  - Provide access to University buildings from internal campus streets; remove existing driveways entering local neighborhood streets where and when feasible.
  - Limit access to residential neighborhoods from the campus to selected streets, while closing most local streets within the campus planning area. Minimize parking impacts associated with the loss of on-street parking, such as the proposed closure of Fifth Street and Tyndall Avenue.
  - Cooperate with the city and neighborhoods in implementing the residential parking permit programs where necessary and the metering of street parking.
  - As a goal, bring all University-related vehicles into the campus parking system (including daily fees, metering, and annual permits).
  - Support city and neighborhood efforts in the installation of appropriate traffic control devices outside the Planning Area which has the net effect of reducing University related traffic impacts.
- Visual Quality
  - Building design:
    - Limit building heights at the campus perimeter to 2 to 3 stories.
    - Encourage the use of "step-back" designs (going from one or two stories, then up as further away from the boundary), especially adjacent to single-family residential areas.
    - Screen outdoor storage, refuse collection, and loading/delivery areas from view.
    - Where feasible, break up bulky structures into smaller masses and/or orient the long sides of buildings perpendicular to (not parallel to) neighborhood boundaries.
    - Consider the use of berming to reduce the perceived height of buildings.
  - Landscaped buffer:
    - Provide a minimum building and parking lot setback of 25 feet from the local street right-of-way for all new permanent construction.
    - Develop the setback as a continuous landscaped buffer, incorporating screen plantings; berms, walls, or elevation changes where feasible; a sidewalk a minimum of 5 feet in width; and night lighting.
    - Coordinate design of the perimeter landscape buffer with appropriate neighborhood constituencies, and be sensitive to existing historical streetscape elements.
    - Where campus streets intersect local neighborhood streets, plant the University street corners with more intensive and/or accent plantings.
  - Adjacency to uses to be retained:
    - For new construction, provide a minimum building and parking lot setback of 10 feet from the property line of uses designated for retention in the area plans.
    - Develop the setback as a landscaped strip, with screen plantings and/or walls, fences, or berms.

## TAB C-3

# LABORATORY PLANNING AND DESIGN CRITERIA

### TABLE OF CONTENTS

General Laboratory Planning and Design Precepts	Page	2
Flexible Laboratory Planning	Page	3
Modular Laboratory Planning	Page	4
Handicapped Accessibility in Laboratories	Page	4
Planning and Design for Laboratory Safety	Page	5
Casework	Page	6
Equipment and Appurtenances	Page	8
Finishes	Page	9
Utility Service and Distribution	Page	9
Air Management Technology	Page	12

### NOTE

- These criteria are intended to apply to both new construction and renovation projects. Obviously, minor renovation projects will not be expected to comply with broad scope criteria, such as redesigning the entire building to satisfy the “modular planning” goal. Wherever these criteria can be reasonably applied to renovation projects with a resulting improvement in the lab environment and without excessive cost penalties, the University desires to do so.

- **General Laboratory Planning and Design Precepts**

- Utilize a central core for special spaces, shared spaces, and building service areas
- Array laboratories around the perimeter of the building
- Locate offices and circulation spaces between the core and the perimeter labs
  - Separate office spaces from the labs
  - Maintain adjacency and visibility to labs
  - Provide a hierarchy of office spaces
    - Faculty
    - Graduate students
    - Research technicians
- Provide a variety of informal gathering spaces, with tack and marker boards in each
  - Eddy spaces in corridors (in addition to lab door recesses)
  - Lounges
  - Break rooms
- Consider providing clean and “dirty” corridors
  - Clean corridors are restricted to people circulation
  - “Dirty” corridors can not be considered as secondary means of egress
  - “Dirty” corridors provide:
    - Utility distribution
    - Air distribution systems
    - Lab equipment (refrigerators, etc)
    - Building equipment (compressors, air pumps, etc)
    - Circulation route for sensitive items
- Air pressurization hierarchies are critical
- Ensure adequate space provisions for major equipment
  - Restrict size of main corridor (code minimum?) to prohibit placement of equipment
  - Utilize a hierarchy of equipment spaces:
    - Shared group spaces in the core
    - Floor space allowance in the “dirty” corridor
    - Open floor and/or space in each lab
    - Available floor space for cart parking
    - Bench top space for analytical equipment (as appropriate)
- Recess outswinging lab doors off the corridor
- Ensure adequate provisions for bulk storage
  - Provide storage for all types of materials required:
    - Dry goods
    - Chemicals
    - Bottled gasses
  - Utilize a hierarchy of distributed storage spaces:

- General building storage
- Floor closets
- Lab closets
- Millwork cabinets
- Open and/or closed shelving
  
- Design bulk storage areas with appropriate fire resistance ratings for materials and quantities
  
- Bulk chemical storage facilities should have these characteristics:
  - Perimeter location
  - Vented room
  - 2-hour fire resistant construction
  - Consider including "blow out" panel
  
- More than 10 gallons (in the aggregate) of class I chemicals must be stored in a cabinet
  - Provide adequate floor space in chemical storage rooms for individual cabinets
  
- **Flexible Laboratory Planning**
  - Plan lab facilities with a distributed hierarchy of shell space for future build-out
    - Floor shells and/or wing shells, as appropriate
    - One or more module shells
    - Semi-custom shells
    - Special shells
  
  - Provide complete utility service into each shell
  - Plan laboratories as "generic" spaces
  - Accommodate different categories of generic labs
    - Wet
    - Dry
    - Teaching
    - Research
    - Biology
    - Chemistry
    - Biochemistry
    - Electronic
    - Geology
    - Physics
  
  - Accommodate "exceptions" and unique conditions in separated custom-purpose spaces
    - Animal holding
    - Biohazard activities
    - Cold rooms (storage or working)
    - Electron microscope
    - Environmental
    - Laser
    - Radioisotope activities
    - Tissue culture activities



- Consider use of "semi-custom" spaces (in modular increments) to provide flexible and/or adaptable space for activities which present unforeseen requirements
- Provide connecting doors between homogenous lab categories (may be used as secondary egress when part of a rated area separation assembly)
- Design lab infrastructure with flexibility to accommodate different categories of labs and/or future design changes without a need to revise the infrastructure systems
  - Piped utility distribution
  - Waste and vent systems
  - Air management
  - Power supply
- Ensure that all equipment and appurtenances maintain the flexibility established in the basic planning and design
  - Modular benches, wall cabinets, shelving
  - Removable benches to allow increasing equipment floor space
  - Coordinate lab top seams with joints in casework
  - Allowance for items such as cylinder racks
- **Modular Laboratory Planning**
  - Design labs using a planning module
  - Module selection should incorporate the following determinants:
    - Building structure (and vibration considerations)
    - Typical bench needs and sizes for each lab category
    - ADA access requirements
    - Ceiling panel modules
    - Epoxy top modules
  - 10'-6" seems to accommodate lab activities and ADA requirements
  - Maintain consistent modular planning throughout the facility
    - Lab "length" is multiple of lab "width"
    - Special use, exception, semi-custom areas
    - Offices
  - Provide for unique "in-lab" needs within the module or multiple modules
  - Provide complete array of utility stubs to each module, even if not always distributed
- **Handicapped Accessibility in Laboratories**
  - Design typical lab benches to be 34" high
  - Provide sit-down handicapped accessible workstation in each lab
  - Appurtenances for each HC station will vary with the category of lab, but in general should include
    - Bench at approximately 30" high
    - Hood
    - Sink with wrist blade faucet handles
    - Lab gasses with wrist blade cock handles
    - Power
    - Storage facilities

- Writing surfaces
  
- Appurtenances must be within regulation-specified reach distances
- Investigate whether sit-down writing surfaces available to all lab users could be designed to accommodate an HC station when needed
- Investigate whether removable benches and/or equipment could be designed to allow retrofit for HC accessibility
  
- **Planning and Design for Laboratory Safety**
  - Resolve lab exiting issues
    - Investigate a design scheme which utilizes "lab suites" thereby allowing individual lab doors to be left open while preventing true corridor doors from being blocked open
    - Investigate providing magnetic hold open / pneumatic closer devices on lab/corridor doors
  
  - Chemicals management
    - More than 10 gallons (in the aggregate) of class I chemicals must be stored in a cabinet
    - Provide acid, solvent, and/or flammable storage cabinets for supply chemicals as appropriate in each lab
      - Under hood or free standing as required by quantity to be stored
      - Properly vented
      - Cabinets should be compartmented to allow segregation of chemicals
  
    - Provide space for storage of waste chemical containers
  
  - Utilize chemical fume hoods only for lab processes, not for storage
  
  - Utilize canopy hoods and/or snorkels to remove heat only
    - Autoclaves
    - Dishwashers
    - Certain analytical equipment
  
  - Provide emergency showers with "hands free" eyewash in corridors
    - Locate within 50 feet of each lab door
    - Do not provide showers in labs
    - Provide a 2" floor drain at each shower location.
    - Provide a local warning alarm for water flow
  
  - Provide flexible hose eyewash at each major bench sink
  
  - Provide adequate space, outside traffic areas, for waste handling
    - Provide secured storage/space for sensitive waste
    - Provide vented storage/space for hazardous waste (maximum 5 gallon container)
    - Utilize a distributed hierarchy of waste spaces
      - Building
      - Floor
      - Individual labs

- Waste categories include
  - Ordinary trash
  - Recycled paper
  - Other recyclables
  - Broken glass (secured)
  - Waste chemicals (secured, vented)
  - Red bag (secured)
  - Orange bag (secured)
  - Radio-hazard (secured)
- Provide a separate break away from labs. Provide space for microwave, refrigerator, coffee pot, sink, etc.
- Provide vision lite in every lab/corridor door
- Provide a fire extinguisher rated for materials being used in lab on a hook in each lab room
- Alarm systems
  - Provide mini-horn/strobe units in environmental rooms and in labs
  - Do not provide smoke detectors in corridors
- Biosafety levels
  - Not all laboratories present a biohazard condition requiring primary and/or secondary barriers
  - Hazards are classified by biosafety level, and required physical barriers are described
  - Biosafety level 1
    - Handwashing sink
  - Biosafety level 2
    - Class I or II biosafety cabinets may be required
    - Waste decontamination facilities
  - Biosafety level 3
    - Class I or II biosafety cabinets are required
    - Glove boxes may be required
    - Access control to the laboratory
    - Specialized mechanical ventilation
  - Biosafety level 4
    - Class III biosafety cabinets are required (or personal pressure suit)
    - Separate building or completely isolated zone
    - Specialized mechanical ventilation and waste management systems to contain hazards
- **Laboratory Casework**
  - Provide wood casework
    - Natural finish, not plastic laminate
    - Except where matching existing metal
    - Except in areas requiring impervious surfaces

- Animal care areas
- Biohazard areas
- Radioisotope areas
- Chemical storage rooms
  
- Include utility chase behind wall/peninsula/island base cabinets
- Demonstrate functional useability of corner area where two base cabinets intersect
- Provide removable access panels at knee spaces and sink cabinets
  - Rear stretcher at knee space should be continuous
  
- Provide pull out writing tablet in casework, using drawer glides
- Provide heavy duty full extension drawer glides (100 pounds minimum)
- Provide pre-fabricated specialty chemical and flammable storage cabinets where required
  
- Laboratory bench tops
  - Epoxy resin tops at all wet or semi-wet areas
  - Acid resistant plastic laminate at dry areas
  - Provide dished top at all major lab sinks
  - Provide lip at all sinks in labs
  - Locate seams in tops coincident with seams in benches to allow for modifications
  - Use light colored tops if lighting efficiency can be demonstrated
  
- Wall / peninsula / island reagent shelving (above lab benches)
  - Custom fabricated using unistrut-type system (not stock item)
  - Extend unistrut from floor through bench top to structure above
    - Seal penetration with epoxy seaming material
    - Do not use a "wrapped splash"
    - Earthquake lip (12" or 18" clear dimension)
    - Acid resistant plastic laminate on wood substrate
      - Do not use an epoxy paint or clear finish
  - Do not install reagent shelving above sinks
  
- Enclosed wall reagent cabinet (above lab benches)
  - 12" clear dimension
  - Glass or opaque doors as requested by User
  - Do not install wall cabinets above sinks
  
- Wall shelving (non-reagent)
  - Must have backing in wall
  - Clear finish wood
  - Heavy duty adjustable kv-type brackets
  - End caps
  - Use unistrut-type reagent shelves for extra deep wall shelving
  - Install top-most shelf 24" minimum below ceiling
  - Do not install wall shelving above sink

- **Laboratory Equipment and Appurtenances**

- Provide a 3'-6" minimum single leaf at each lab/corridor door
- Discuss fume hood selection with UA Facilities Design & Construction
  - Investigate special user requirements
    - Laminar flow clean hoods
    - Radioisotope hoods
    - Perchloric acid hoods
    - Biosafety cabinets
- Laminar flow clean hoods
  - Used only to protect process (not to protect operator)
  - Not exhausted
- Radioisotope hoods
  - Special purpose fume hood with hepa-filtered exhaust discharge
  - Generally uses slightly higher face velocity than conventional fume hoods (125 fpm)
  - Requires welded stainless steel exhaust duct system
  - Can be open or gas-tight (glove box)
- Perchloric acid hoods
  - Straight exhaust duct run (no horizontal offsets) is mandatory
  - Requires automatic wash down system
    - Timer-controlled for washing once per week
    - Discharge must be carried to the lab waste system
  - Requires welded stainless steel exhaust duct system
- Biosafety cabinets
  - Identify specific type of hood required, based on User process
    - Class I biosafety cabinet: 100 fpm, single pass air, out through hepa filter
    - Class II-A biosafety cabinet: 100 fpm, 70% recirculated through hepa, 30% exhaust to room through hepa
    - Class II-B1 biosafety cabinet: 100 fpm, 30% recirculated through hepa, 70% exhausted to exterior through hepa
    - Class II-B2 biosafety cabinet: 100 fpm, 100% exhausted to exterior through hepa
    - Class II-B3 biosafety cabinet: 100 fpm, 100% exhausted to exterior through hepa, plena under negative pressure to room
    - Class III biosafety cabinet: gas-tight cabinet, supply through hepa, exhaust through 2 hepa
  - Biosafety cabinet exhausts may be manifolded together, but not with chemical fume hoods
- Exhaust hood control
  - Chemical fume hoods may not be User controllable, must be on 24 hours

- Also includes radioisotope and perchloric acid hoods
- Consider off-hours setback and vav systems, for energy conservation
- Interior recirculation ("supply") fans of biosafety cabinets may be User controllable
  - Must be interlocked with hood and/or general exhaust fans to ensure that operator safety and room pressure are not compromised
  - Applies to all class II biosafety cabinets, only
- Provide tank farm with chains, not dividers, when required
  - Design to be near the door, for ease of service
  - Utilize University-standard tank manifold
- Provide wall space for UA-standard towel and soap dispensers at each lab sink
- Provide tack surfaces and writing boards in all labs
- Carefully coordinate all equipment specifications
  - Fixed or moveable, must specify details
  - Sizes and floor space allowances
- Use electric autoclaves instead of steam
- **Laboratory Finishes**
  - Floor finishes
    - Available choices
      - Vinyl composition tile is appropriate for most labs
      - Epoxy sealer is also appropriate for most labs, including chemistry
      - Seamless vinyl provides a "pan" in very wet areas
      - Seamless vinyl is cleanable for biology labs
    - Continue flooring under casework
    - Seal toekick of all benches (to prohibit water penetration)
    - Use topset cove base at toekicks
  - Provide epoxy wall paint in all wet labs
    - Also on ceilings, if hard surface
  - Ceilings
    - Available options
      - Suspended acoustical tile ceilings are acceptable in most laboratories
      - No ceiling is an option where appropriate
      - Provide hard ceilings only where required by lab activity
  - Provide a sealed sleeve with a lip at all floor penetrations
- **Laboratory Utility Service and Distribution**
  - Utilities distribution

- Overhead, in corridor ceiling
- Valve on each utility stub, in corridor
- Drop on wall surface or freestanding to each lab bench
- Distribute to positions in utility space at rear of casework
  - Make joints in horizontal piping only at removable panels
- Visible and accessible
- Consider special delivery systems where appropriate
  - Lab gas "pedestal" or "drop pods"
  - Electric "drop cords"
- Utilities on bench tops
  - Place turrets toward rear of bench
  - Use turrets with angled discharge to enhance hose management
- Utilities racked on reagent shelf
  - Generally avoid (hoses get in the way)
  - If doing so, rack on unistrut verticals, not shelf
  - If doing so, maintain 22" clear height above bench top
- Piped utilities
  - distribute to benches and hoods
    - controls must be outside hoods
- building provides central
  - potable water
  - ro water
    - Provide special (di) polish at individual labs
  - Natural gas
    - Some Users prefer bench top cylinders for gas service
  - Compressed air
    - Confirm if required
- Building does not provide central
  - Vacuum
  - Hot water
  - Specialty gasses
  - Provide in individual lab as needed
- Use building chilled water wherever possible for process

- Provide heat exchanger between building and process
- Recirculate chilled water (do not use "single pass")
- Where demand is excessive, varies from building system, or need is critical
  - Use stand alone chiller
  - Consider placing chiller on emergency power system
- Waste system and piping
  - Do not use acid neutralization systems (building or stand-alone)
  - Separate lab waste from domestic waste
    - Utilize separate piping system to exterior of building
    - Provide sampling manhole for lab waste piping
    - Combine lab and domestic waste piping after sampling manhole
  - Use acid-resistant piping system for lab waste
- Lab sinks
  - Confirm with User need for large/deep sinks
  - Plan major sinks at ends of benches, in base cabinet
  - Use gooseneck faucets with wrist blades at all sinks
  - Cup sinks are not routinely needed on benches or in hoods
    - Install only is specifically required
    - Always provide lip
    - In hoods, sink must be at rear to avoid trap being in under-hood storage cabinet
- Do not use plastic di faucet
  - Aluminum faucet (with plastic piping) is acceptable
    - Self-closing
    - Easily replaceable
- Floor drains
  - Use only when required to discharge condensate or other similar non-hazardous material
  - Must be lipped and guarded
- Electrical & telecommunications typically required
  - Provide an adequate number and arrangement of circuits
  - Provide an adequate number and arrangement of 120v receptacles
  - Provide an adequate number and arrangement of 208v receptacles
  - Provide wiremold electrical distribution above all lab benches
    - Double raceway
    - Install quantity of receptacles as required by User process
    - Receptacles above bench must have gfcı protection *within 5' of water source*
    - Install of data jacks as required by User in second raceway
  - Label each receptacle's circuit



- Alternate circuits in each lab and in each wire mold run
- Provide wall phone jacks where required. Do not provide data jacks at wall phone jacks.
- Provide data jacks along benches where required.
  
- Lighting
  - Place general fixtures to eliminate shadows from work surfaces
  - Do not rely on general fixtures for the complete lighting environment
  - Provide task lighting above lab benches and other work surfaces
    - Utilize 2-tube fixtures with shades to minimize glare
  - Evaluate color and reflectivity of finishes and bench tops as part of lighting design
  - Provide emergency lighting in each lab room or distinct space
  
- **Laboratory Air Management Technology**
  - Preferred system
    - Building ahu to supply make up air to labs
    - Lab fan coil units to remove sensible cooling load of lab equipment
    - Investigate manifold and vav exhaust system if project has many hoods
      - Use multiple fans in manifolded system
        - To allow programmed maintenance
  - Basic system design issues
    - Provide pressure hierarchy between lab spaces
      - Provide capability to measure velocity and pressure downstream of terminal boxes
    - Provide exhaust discharge velocity of 3000 - 3500 fpm
      - Provide bypass on manifold vav systems at roof
    - Provide filtration or scrubbing for hazardous emissions
  - Temperature control
    - Set individual room thermostats at 75°F, ± 2°F
  - Humidity control – discuss with UA FDC
  - Filtration requirements
    - Provide minimum 4" deep 30% efficiency filter banks in 100% outside air systems
  - Design exhaust systems for materials being removed
    - Heavier or lighter than air
    - Concentrations and processes
    - Discuss design hood face velocity with UA FDC
    - Limit use of canopies and snorkels to heat removal

- Ductwork materials
  - Spiral 316L stainless steel shall be used for fume hood applications
  - PVC coated galvanized may be used on manifold vav systems applications
    - Clearly specify strict construction controls
  - Welded 316L stainless steel must be used for perchloric acid hoods
- Design exhaust system for noise reduction
  - Duct size, design, and route
  - Fan selection and location
  - Low pressure drop hood
- Specify appropriate vent conduits for storage cabinets
  - Explosive / flammable
  - Vapors

## TAB C-5

### CUSTODIAL PLANNING AND DESIGN

Custodial Services are inherent to the operations of buildings and proper service areas must be considered with all other areas during the programming and planning stages of each building.

Universally accepted standards have yet to be set for custodial closets and storerooms. Certain criteria however, for size, shape, location, and special appurtenances, have been developed which are compatible with present cleaning procedures and today's cleaning equipment.

Comprehensive custodian operations encompass three major areas:

- Custodial Closets
  - Custodian Storage Areas
  - Trash Disposal Systems
- 
- CUSTODIAN CLOSETS

Should be planned to function primarily as the workrooms of men and women responsible for cleaning the interior surfaces of the building. The University of Arizona has developed the following criteria for custodian closets:

- Size should be a **minimum** of 80 – 100 square feet, with 7-8 foot minimum width.
- Recessed light fixtures (to allow for clearance of long broom and mop handles) providing 75 F.C. light.
- Adequate ventilation.
- Pegs for storage of rotary brushes.
- Hangers for wet mops over the sink.
- Hangers and wall space for dust mops and brooms.
- Hard surface walls impervious to water.
- Shelves in closet to accommodate supplies in case lots, and to allow for storage of liquids in original 5 or 6 gallon containers.
- A 36" wide door that swings out, not into the room.
- Hot and cold water outlets not less than 24" above a floor type basin. Basin curb should be 6" minimum above the floor.
- A grounded 20 Amp. Duplex outlet in open wall space, not behind shelves, for recharging battery operated equipment.

Location of custodian closets is very important. They should be centrally located with no area in a building more than 150 feet in walking distance from a "wet" closet. Each closet should not serve in excess of 15,000 square feet.

Buildings should have custodian closets on every floor. Good locations for secondary custodian closets are:

- Close to elevators
- Close to main pedestrian areas
- Between two restrooms

Criteria For Vertical Transportation

- There should be an elevator in every multi-storied building.
- The elevator should land on every floor including the basement.

- The elevator should be available to custodian and maintenance personnel.

It is considered poor planning to locate a custodian closet:

- At the dead end of a corridor. A situation such as this results in many unnecessary steps for the custodian.
- On a stair landing. A stair-landing closet would cause the custodian to always carry utensils and equipment up and down stairs.
- Inside another room (unless that closet serves only that room).
- Under stairs. Low ceilings and narrow dimensions are hard to ventilate.
- In narrow spaces. The custodian must move his equipment into the hall to utilize a narrow room. Square shaped closets are most efficient.

Telephone switching gear, elevator controls, electric panels or other service functions are not compatible with custodian operations, and should not be located inside custodian closets. Openings to pipe chases or mechanical equipment areas should not be located inside custodian closets.

- **LARGE STORAGE ROOMS**

- Every large building should have a storeroom for custodian equipment, bulk supplies and custodian lockers. Buildings larger than 150,000 sq.ft. should contain two such rooms. Storage areas should be designed specifically for custodian storage, not for dual usage. Planning should be done in consultation with those who will be responsible for maintaining the building.
- Dock or elevator facilities must be provided.
- Doors should be no less than 36" wide and open out. Storage areas should contain a minimum of 144 square feet. 12' x 12' are good dimensions.

- **TRASH DISPOSAL**

- Disposal of the trash and garbage produced by every cleaning operation is an integral part of a comprehensive program. The University of Arizona's Physical Plant utilizes compaction and physical removal by truck for all trash and garbage. A properly sized, fire-resistant trash room shall be planned into each new campus building. Where debris from kitchens and dining halls, or where animal matter is involved, refrigerated trash storage rooms shall be provided.

- **SUMMARY**

- Proper custodian closets, carefully planned and sized storage rooms or custodial supplies, and consideration of refuse collection and disposal requirements, are prime ingredients in any efficient housekeeping program.

## TAB C-6

### KEYLESS ACCESS AND SECURITY SYSTEM GUIDELINE

The University of Arizona has implemented a Keyless Access and Security System program to provide a cost effective, efficient, and maintainable means of providing and managing access into campus buildings for the university community, contractors and visitors. The focus of the system is to address issues of loss prevention, personal safety, and convenience through the use of this standardized technology. The system utilizes the University's CatCard as the "key" since it is universally deployed to all campus constituencies.

The principle focus of the program addresses **building perimeter access points**. Most University facilities are unlocked during normal (and sometimes extended) business hours, during which time keys are not required to enter the building. However, when the buildings are supposed to be closed and locked, it is the program's intent to provide entry through the use of the University of Arizona CatCard rather than with the use of a physical key.

In order to equip new university building with this system, project consultants will need to provide a design and produce construction documents that have the following accommodations for a keyless access and security system:

- **RISER** - A riser for the building's Keyless Access/Security System. This riser is required to be stacked vertically within a building to permit the Keyless Access/Security System to be wired from floor to floor
- **HEAD END EQUIPMENT** - Space and some utilities for the Keyless Access/Security System head end equipment directly adjacent to the riser. This particular equipment exists on only one floor of the building. This equipment also needs to be provided with three duplex 120VAC electrical outlets and one voice/data jack.
- **FIELD DOOR CONTROLLER PANELS** - Space and power for Keyless Access field door controller panels at various locations throughout the building as determined by the keyless access system design. These panels will require hardwired, 120VAC power.
- **RACEWAYS** - Conduit and junction boxes will need to be provided for routing certain portions of the Keyless Access/Security System local area network. Not all of the keyless access and security system wiring is required to be located in conduit. In very general terms, conduit is required between the equipment that is installed on walls up to accessible, above ceiling space or the building's cable tray.
- **DOOR HARDWARE** – Designated doors will have hardware that needs to interface and/or be controlled by the Keyless Access system. Doors that have keyless access hardware requirements may either have their hardware specified and provided under the general construction contract (for example – in the door hardware package) or have their hardware provided by Amer-X as part of the Keyless Access/Security System installation.
- **DOOR FRAMES** - Doorframes - pre-prepared from the manufacturer that can easily accommodate the addition of equipment for electronic operation. These frames typically include a handy box at the top of the doorjamb and a latch strike mud pocket that is deep enough for an electronic strike.

*Consultant shall coordinate door frame requirements during the design phase of a project.*

All the Keyless Access/Security System wiring is low voltage; only the head end equipment and field door controller panels require 120VAC. As such, most of the wiring is not required to be located in conduit. The Keyless Access/Security System is not required to be provided with emergency power; each building's system is provided with sufficient battery backup to provide at least four hours of standby operation. In the event a particular installation calls for longer standby power capability, the 120VAC power could be on an emergency circuit. The building Keyless Access/Security System communicates with the main server through phone and data lines; no connection to a hardwired network is necessary.

The following information is intended to explain the detailed requirements of each portion of the Keyless Access/Security System infrastructure that will need to be provided by under the general construction contract.

### **RISER**

- A minimum 2" riser for each major wing of the building. The riser must serve every occupied floor of a building.
- One 12"x12"x4" box at each floor (see Notes below).
- A 1" conduit from the riser box to the building's cable tray

#### Notes:

- A building may only have one riser, but larger, more complex buildings may have more than one.
- Amer-X will provide the riser boxes for each floor of the building

### **HEAD END EQUIPMENT**

#### **Security Control Panel**

- One 16"x16"x4" box for security control panel (see Notes below)
- One, duplex 120VAC receptacle for panel power. This receptacle is not required to be on emergency circuit. The circuit for this receptacle is not required to be dedicated.
- One, voice/data jack with an RJ31X jack. The data side of this jack is used by the keyless access system panel.

#### Notes:

- Installation of security system wiring and the phone line cord between control panel and voice/data jack is provided by Amer-X.
- 120VAC-24VDC transformer and transformer cover for the power receptacle will be provided and installed by Amer-X.
- Amer-X receives the box for security panel from the equipment manufacturer. Amer-X will provide this box to the electrical contractor for installation during building construction.

#### **Keyless Panel and Network Connection**

- One 16"x22"x6" box for keyless access panel and net connection (see Notes below)
- Two, duplex 120VAC receptacles - one for keyless access panel power, one for the network connection power. This receptacle is not required to be on emergency circuit. The circuit for this receptacle is not required to be dedicated.
- One, voice/data jack with an RJ31X jack. The voice side of this jack is used by the security system panel.

#### Notes:

- Installation of keyless access system wiring and the network connection cord between control panel and voice/data jack is provided by Amer-X.
- 120VAC-24VDC transformers and transformer covers for the power receptacles will be provided and installed by Amer-X.
- Amer-X receives the box for keyless access panel from the equipment manufacturer. Amer-X will provide this box to the electrical contractor for installation during building construction.

### **FIELD DOOR CONTROLLER PANELS**

Depending on the number and location of controlled doors, keyless access field door controller panels will need to be installed at various locations in the building. At each of these locations, the following equipment is required:

- One 16"x22"x6" box for the field door controller panel (see Notes below)
- 120VAC power hardwired into the box. This circuit is not required to be dedicated or on emergency power.

Notes:

- The panels can be installed above ceilings, in equipment rooms, or other similar areas.
- The 16"x22"x6" holds the largest field controller panel. This size box may not be installed at every location, but space should be provided to accommodate the "worst case" box.
- Amer-X receives the boxes for the field controller panels the equipment manufacturer. Amer-X will provide these boxes to the electrical contractor for installation during building construction.

### **RACEWAYS**

All of a building's perimeter access points will need to be provided with wiring pathway that will permit the doors to be controlled electronically. Each building perimeter access point shall be provided with the following equipment:

- Door Contacts
- Electronic Locking (either electric strikes or latches, or magnetic locks)
- Request to Exit Device

In addition, certain, designated building entries (as determined by the Keyless Access/Security System design) shall be provided with the following additional keyless access equipment:

- Card reader
- PIN pad

Raceways will need to be provided from accessible, above-ceiling spaces to this equipment at each door where this equipment is located.

Notes

- If magnetic locks are used on a door, a keyed bypass switch will be required. This is an additional piece of equipment that will also require conduit to the accessible, above-ceiling space.
- For storefront-type entries, the Keyless Access/Security System wiring can be routed through the storefront mullions. This is a field installation coordination issue that Amer-X addresses with the storefront installers during construction.
- For all glass entries, a post or bollard will be required to mount some of the keyless access equipment (card reader, PIN pads). This type of installation requires greater consideration during the project's design phase.

### **DOOR HARDWARE**

Electronic locking requires special hardware for the doors designated to be controlled by the Keyless Access/Security System. In general terms, there are three types of electronic locking hardware: electric strikes, electric latches, and magnet locks. Until the building's design reaches a point where the door types are well defined, it cannot be determined which type of electronic locking hardware will be used. However, the following should be considered:

- Magnetic locks are generally the most costly way to electronically lock a door. They should only be used when the other two alternatives are not feasible (i.e. double doors that require panic hardware and cannot have a mullion).
- Electric strikes can be installed in almost all doorframes or mullions and are the most economical way to electronically lock a door.
- Electronic latches are typically used where the door is required to remain positively latched (i.e. fire doors) in the event of a Keyless Access/Security System failure.

### **DOOR FRAMES**

Installation of electronic locking on doors is facilitated by having doorframes pre-prepared from the manufacturer for electronic hardware and controls. This entails the following

- A handy box provided at the top of the door frame, located 6 inches off the latch side of the frame

### **KEYLESS ACCESS/SECURITY SYSTEM INSTALLATION**

As the University's sole source, keyless access and security systems vendor, Amer-X performs the following installation tasks associated with the keyless access and security system:

- Installation of head end and field panels in boxes installed by the electrical contractor
- Installation of 24VDC transformers and transformer covers on duplex receptacles installed by the electrical contractor
- Connection of power source to panels
- Connection of phone/data lines to jacks installed by the electrical contractor
- Coordination with construction trades, such as window and door installers, to facilitate installation of peripheral devices
- Installation of peripheral devices (door contacts, card readers, PIN pads, electric strikes, etc.)
- Installation of the low voltage Keyless Access/Security System wiring - both in conduits provided by electrical contractor (in walls and vertically through the building) and the data loop local area network wiring between panels and devices (routed similar to telecommunication lines through above ceiling spaces).

### **DESIGN PHASE INVOLVEMENT**

Please refer to the following process descriptions and flow chart for how Amer-X should be involved in the design process.



## **DESIGN PHASE INVOLVEMENT, PROCESS AND FLOW CHART**

### **Schematic Design**

- Consultant, User group, and Amer-X meet
- Introduction of keyless access/security system
- Review building layout, functions, different building constituencies, and expected building operation. See Note (1) below.

### **Design Development**

- Amer-X develops preliminary system design and budget. Submits copy to Project Coordinator, Consultant, and User group
- Consultant, User group, and Amer-X meet. Review preliminary design with user and consultant. Make modifications/deletions/additions as determined by refined understanding of building operations
- Amer-X develops final system design and budget. Submit copy to Project Coordinator, Consultant, and User group. Provides standard door details, riser diagram, door hardware requirements to consultants

### **Construction Documents**

- Amer-X verifies coordination of consultant documentation with final system design

### **Construction Phase**

- Electrical Contractor installs pathways (riser and door conduit) according to specifications
- Door contractor preps doors and jambs for equipment, according to specifications
- University establishes purchase order with Amer-X for system installation
- Amer-X coordinates field device installations with affected contractors

---

#### Schematic Design Note (1):

Amer-X meets with consultants and user group(s) after schematic design to introduce the keyless access/security system program, and describe the system's capabilities and options. This is where the dialog on how the users expect the building to operate from an access point of view begins. A review of the functions that take place in the building, the different user groups/constituencies, and any special concerns about asset protection, special activities (cash handling, pharmaceutical storage, etc.) and access management should also take place at this time.

User groups will be asked to think about how they need and/or want the building to be accessed

During normal business hours  
After normal business hours  
For special events

User Groups will also be asked to think about who they need and/or want to be able to access the building when the building is:

Normally open  
Supposed to be closed



University of Arizona Security System Door Details and Illustrations  
Single Exterior Door

All wire runs not in conduit must be supported from approved hangers, installed not less than 3 ft on center

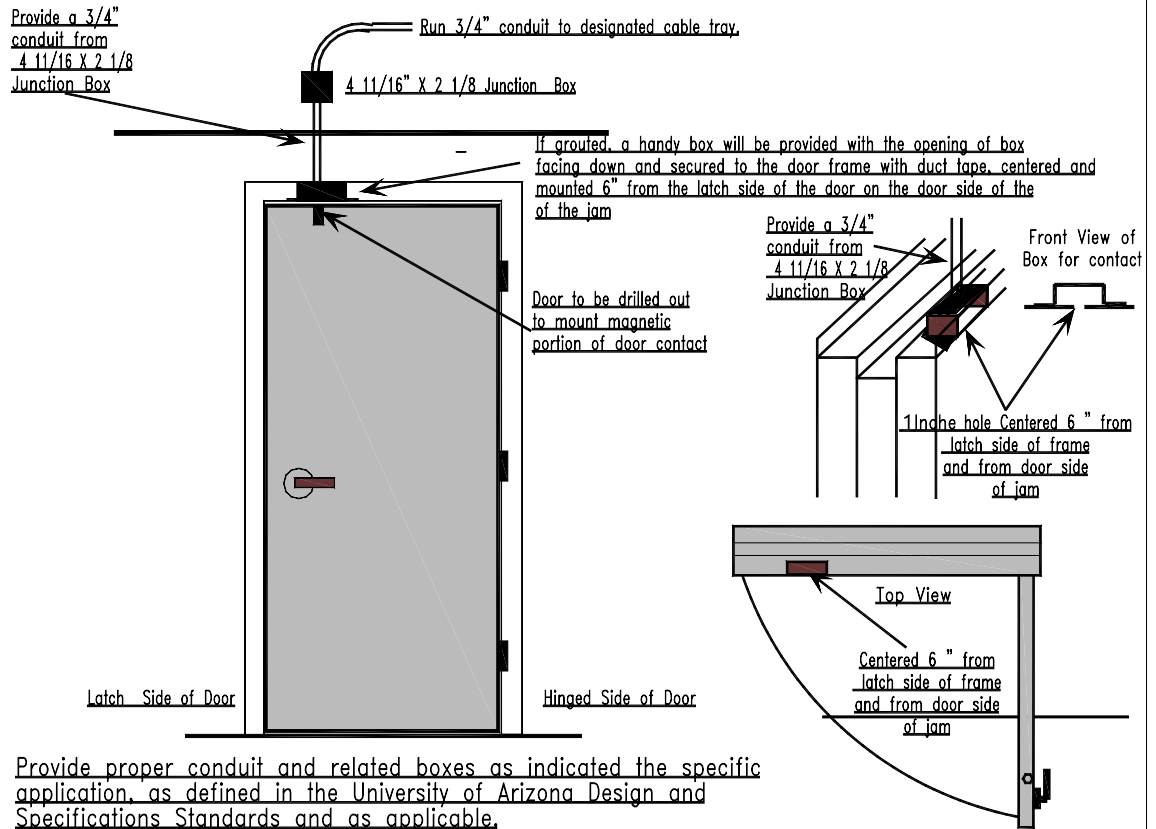

Provide proper conduit and related boxes as indicated the specific application, as defined in the University of Arizona Design and Specifications Standards and as applicable.

Keyless Access Security Cable	Wire Size	Approvals	Belden Cable Number or Equal
Security Data Loop	18/2	UL, NEC, Type CMP, CL2P	6300 FE

Door Details and Illustrations  
Single Exterior Door  
Security System Only

UNIVERSITY OF ARIZONA MANUAL OF DESIGN SPECIFICATION STANDARDS		
STANDARD DETAIL: SINGLE EXTERIOR DOOR, SECURITY SYSTEM ONLY		
DRAWN BY: KML	DETAIL NO. C6-D1	REVISIONS
APPROVED BY: FD&C		.
ACAD: C6-D1		.

University of Arizona Keyless Access Security Systems Door Details and Illustrations  
Single Exterior Door

All wire runs not in conduit must be supported from approved hangers, installed not less than 3 ft on center

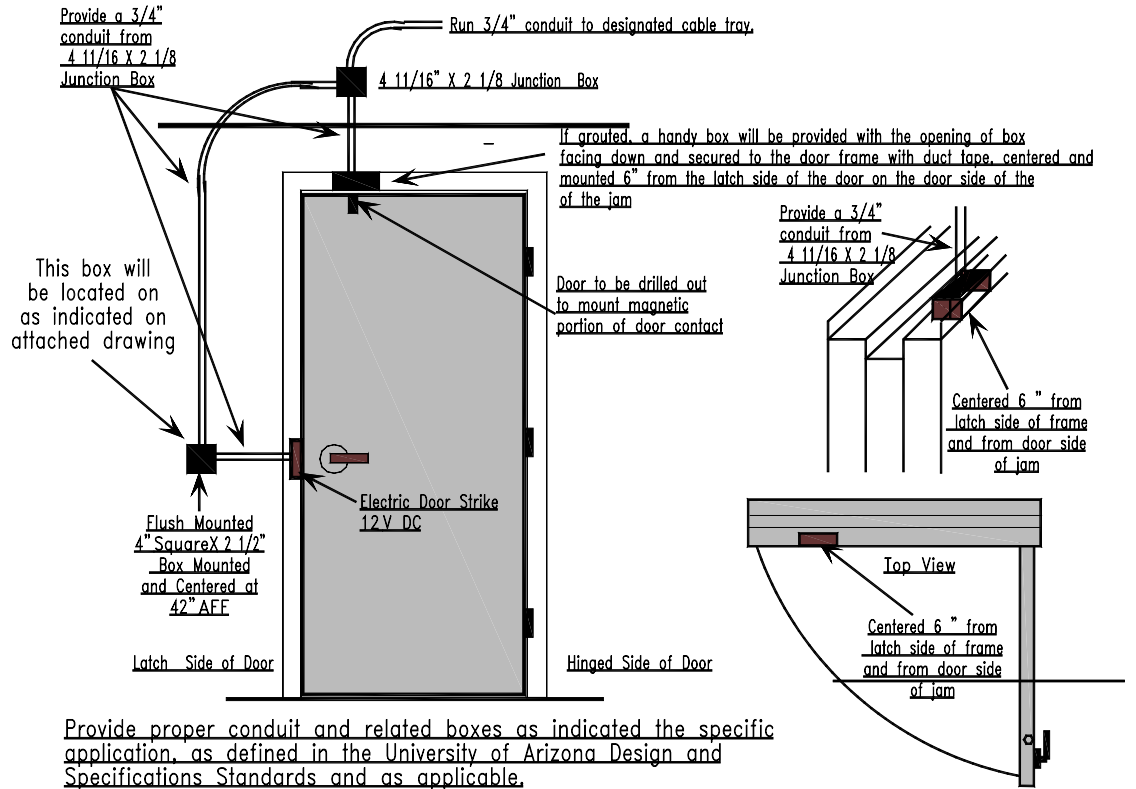

Provide proper conduit and related boxes as indicated the specific application, as defined in the University of Arizona Design and Specifications Standards and as applicable.

Keyless Access Security Cable	Wire Size	Approvals	Belden Cable Number or Equal
Keypad	22/12 Shielded	UL, NEC, Type CMP, CL2P	6509 FE
Card Reader	18/6 Shielded	UL, NEC, Type CMP, CL2P	6304 FE
Electric Strike	18/2	UL, NEC, Type CMP, CL2P	6300 UE
Magnetic Lock	18/2	UL, NEC, Type CMP, CL2P	6300 UE
Door Contact	22/4	UL, NEC, Type CMP, CL2P	6502 UE
485 Data Loop	24/2	UL, NEC, Type CMP, CL2P	6600 FE
Security Data Loop	18/2	UL, NEC, Type CMP, CL2P	6300 FE

Door Details and Illustrations  
Single Exterior Door

UNIVERSITY OF ARIZONA MANUAL OF DESIGN SPECIFICATION STANDARDS		
STANDARD DETAIL: SINGLE EXTERIOR DOOR, ACCESS AND SECURITY		
DRAWN BY: KML	DETAIL NO. C6-D2	REVISIONS
APPROVED BY: FD&C		
ACAD: C6-D2		

University of Arizona Keyless Access Security Systems Door Details and Illustrations  
Double Exterior Door with Mullion

All wire runs not in conduit must be supported from approved hangers, installed not less than 3 ft on center

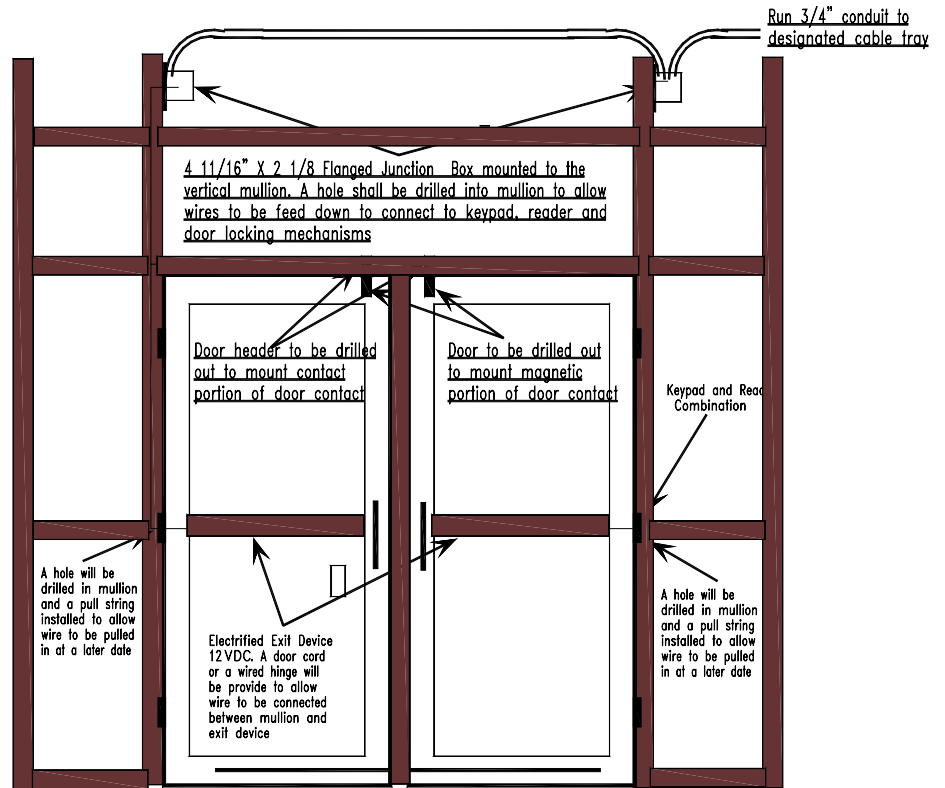

Provide proper conduit and related boxes as indicated the specific application, as defined in the University of Arizona Design and Specifications Standards and as applicable.

Keyless Access Security Cable	Wire Size	Approvals	Belden Cable Number or Equal
Keypad	22/12 Shielded	UL, NEC, Type CMP,CL2P	6509 FE
Card Reader	18/6 Shielded	UL, NEC, Type CMP,CL2P	6304 FE
Electric Strike	18/2	UL, NEC, Type CMP,CL2P	6300 UE
Magnetic Lock	18/2	UL, NEC, Type CMP,CL2P	6300 UE
Door Contact	22/4	UL, NEC, Type CMP,CL2P	6502 UE
485 Data Loop	24/2	UL, NEC, Type CMP,CL2P	6600 FE
Security Data Loop	18/2	UL, NEC, Type CMP,CL2P	6300 FE

Door Details and Illustrations  
Double Exterior Door  
with Mullion

UNIVERSITY OF ARIZONA MANUAL OF DESIGN SPECIFICATION STANDARDS		
STANDARD DETAIL: DOUBLE EXTERIOR DOOR WITH MULLION		
DRAWN BY: KML	DETAIL NO.	REVISIONS
APPROVED BY: FD&C	C6-D3	+
ACAD: C6-D3		+
		+
		+

University of Arizona Keyless Access Security Systems Door Details and Illustrations  
Double Exterior Door with Magnet Locking Devices

All wire runs not in conduit must be supported from approved hangers, installed not less than 3 ft on center

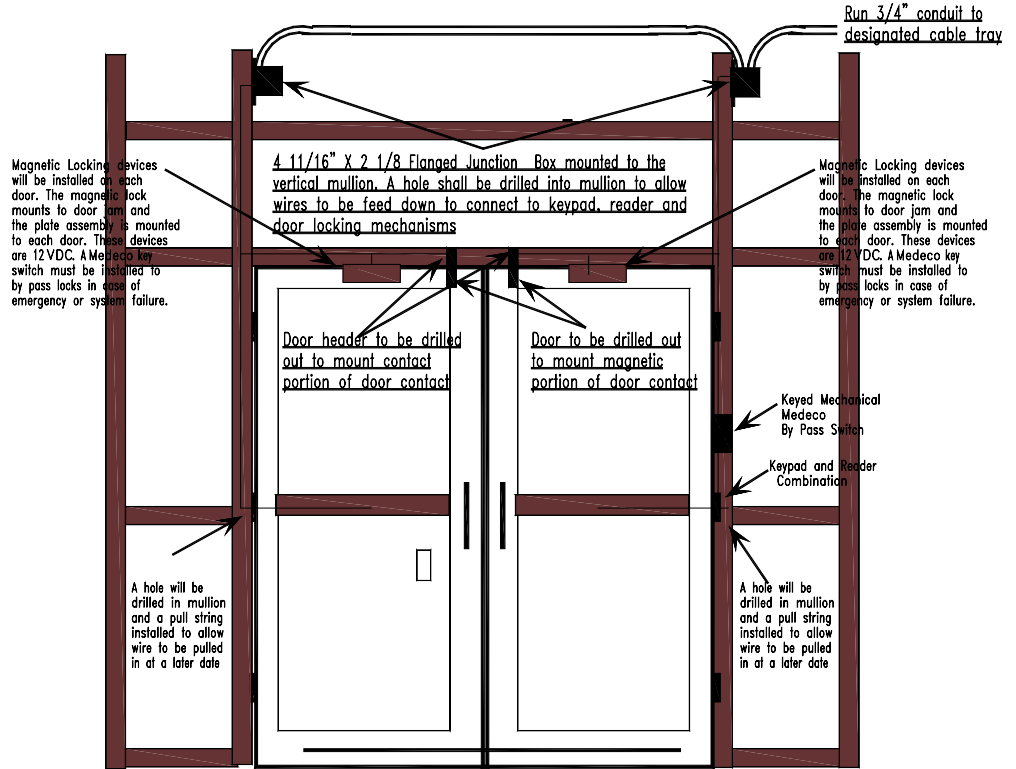

Provide proper conduit and related boxes as indicated the specific application, as defined in the University of Arizona Design and Specifications Standards and as applicable.

Keyless Access Security Cable	Wire Size	Approvals	Belden Cable Number or Equal
Keypad	22/12 Shielded	UL, NEC, Type CMP,CL2P	6509 FE
Card Reader	18/6 Shielded	UL, NEC, Type CMP,CL2P	6304 FE
Electric Strike	18/2	UL, NEC, Type CMP,CL2P	6300 UE
Magnetic Lock	18/2	UL, NEC, Type CMP,CL2P	6300 UE
Door Contact	22/4	UL, NEC, Type CMP,CL2P	6502 UE
485 Data Loop	24/2	UL, NEC, Type CMP,CL2P	6600 FE
Security Data Loop	18/2	UL, NEC, Type CMP,CL2P	6300 FE

Door Details and Illustrations  
Double Exterior Door  
with Magnetic Locking Devices

Prepared 4/15/04 (Revised)DJJP

UNIVERSITY OF ARIZONA MANUAL OF DESIGN SPECIFICATION STANDARDS		
STANDARD DETAIL: DBL EXTERIOR DOOR W/MAGNETIC LOCKING DEVICES		
DRAWN BY: KML	DETAIL NO. C6-D4	REVISIONS
APPROVED BY: FD&C		-
ACAD: C6-D4		-
		-
		-

University of Arizona Keyless Access System  
 Control Panel  
 Layout and Power Requirements

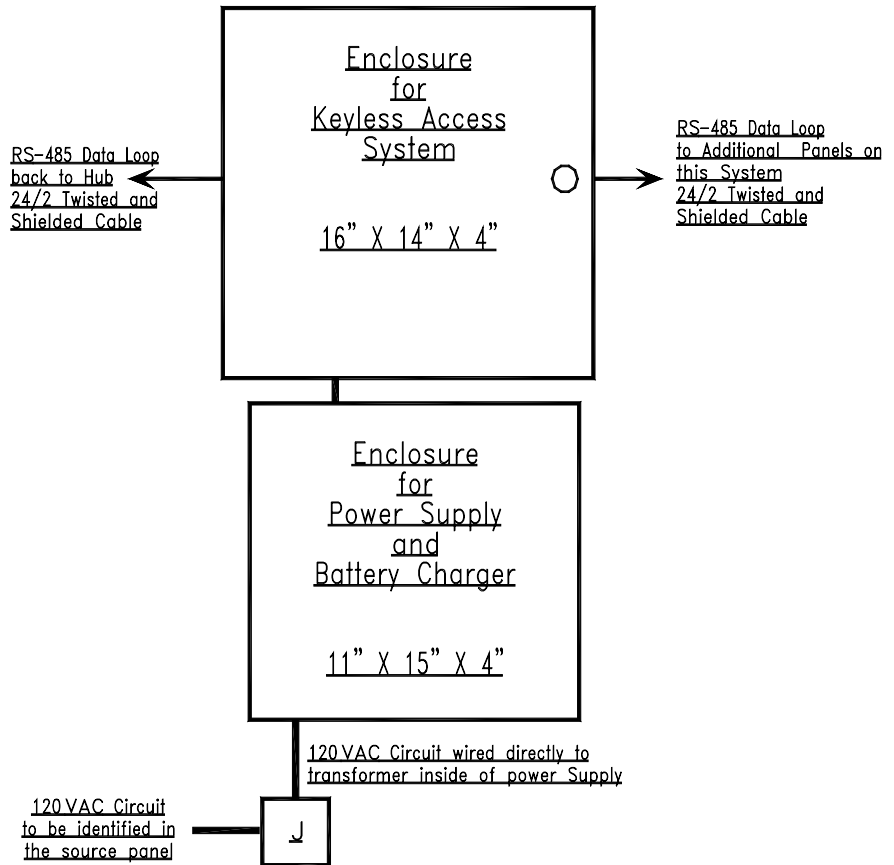

Provide proper conduit and related boxes as indicated the specific application, as defined in the University of Arizona Design and Specifications Standards and as applicable.

UNIVERSITY OF ARIZONA MANUAL OF DESIGN SPECIFICATION STANDARDS		
STANDARD DETAIL: LAYOUT AND POWER REQUIREMENTS		
DRAWN BY: KML	DETAIL NO.	REVISIONS
APPROVED BY: FD&C	C6-D5	. . .
ACAD: C6-D5		. . .

University of Arizona Keyless Access System Control Panel  
 Layout and Power Requirements

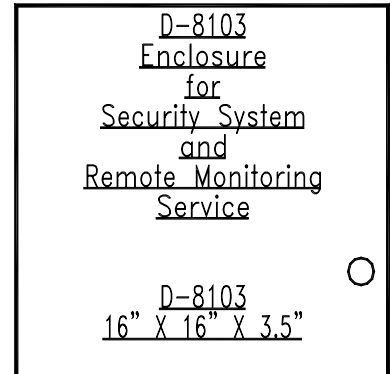
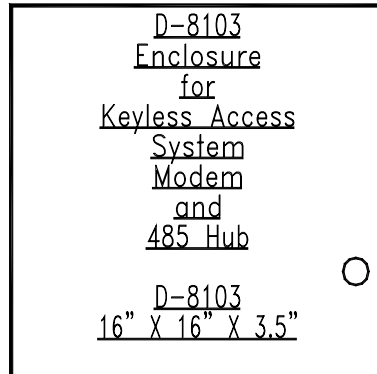

Voice Grade Telephone Jack #1  
 is for Keyless Access Modem



Voice Grade Telephone Jack #2  
 is for Security Panel

Minimum separation  
 between receptacles  
 will be 6" on center

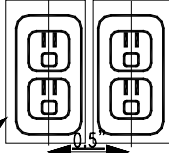

Receptacle #1  
 is for Transformer  
 to Power Modem

Receptacle #2  
 is for Transformer  
 to 485 Hub

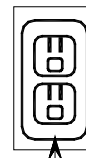

Receptacle #3  
 is for Transformer  
 to Security Panel

All Receptacles will have  
 a protective cover to prevent  
 the transformers from  
 being unplugged  
 Cover provided by  
 Amer-X



Provide proper conduit and related boxes as indicated the specific  
 application, as defined in the University of Arizona Design and  
 Specifications Standards and as applicable.

UNIVERSITY OF ARIZONA MANUAL OF DESIGN SPECIFICATION STANDARDS		
STANDARD DETAIL: ACCESS SYS CTRL PANEL LAYOUT/PWR REQ'MENTS		
DRAWN BY: KML	DETAIL NO.	REVISIONS
APPROVED BY: FD&C	C6-D6	-
ACAD: C6-D6		-



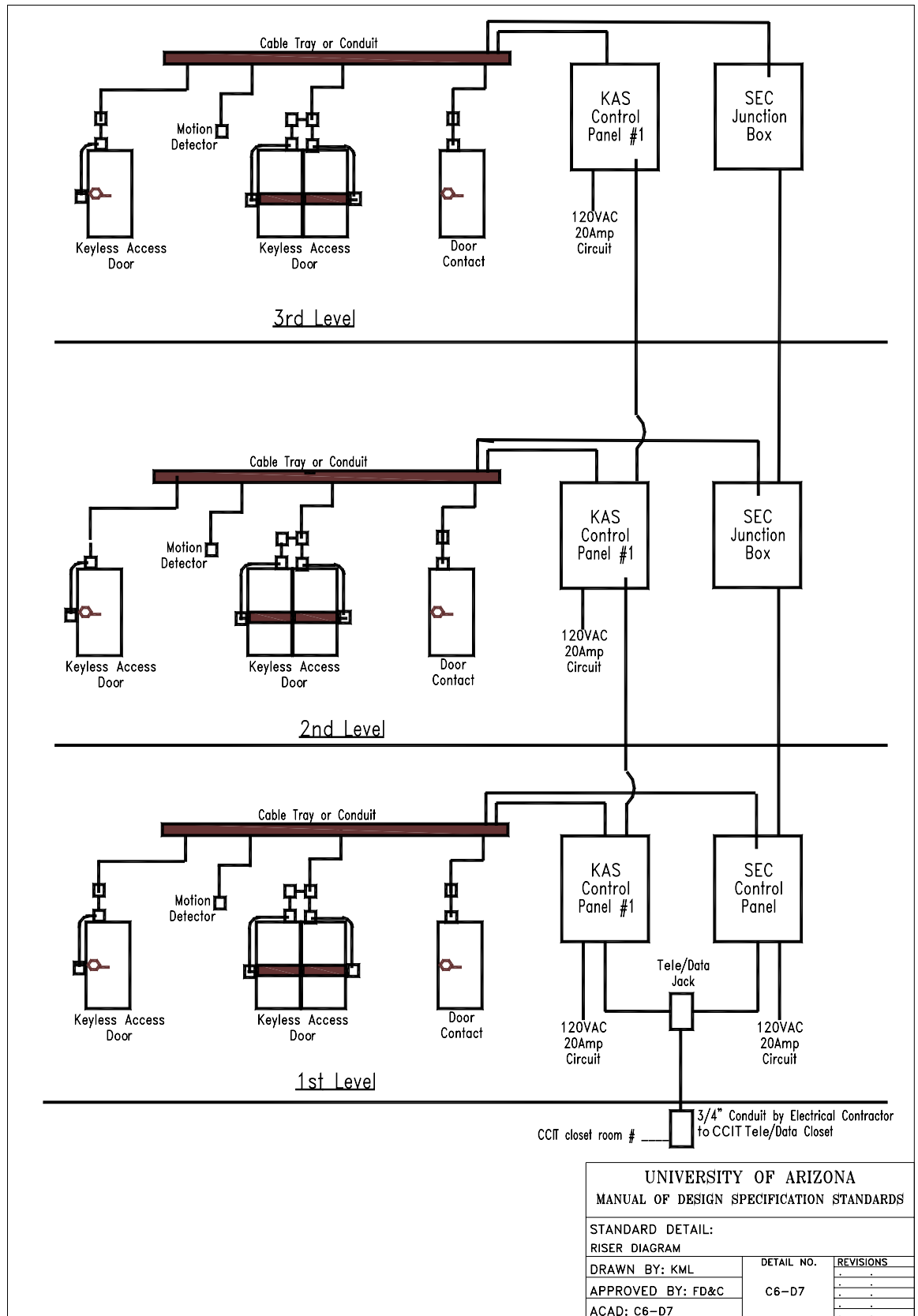

<b>UNIVERSITY OF ARIZONA</b>		
<b>MANUAL OF DESIGN SPECIFICATION STANDARDS</b>		
STANDARD DETAIL: RISER DIAGRAM		
DRAWN BY: KML	DETAIL NO. C6-D7	REVISIONS
APPROVED BY: FD&C		.
ACAD: C6-D7		.

University of Arizona  
 Keyless Access and Security Systems  
 Symbol List

KAS Control	Keyless Access Control with Hub and Modem
CR	Cat Card Reader
CR PP	Cat Card Reader with Pin Pad for PIN
ES	Electric Strike or Locking Device
ML	Magnetic Locking Device
SEC Control	Security Control Panel with Communicator
KP	Security System Keypad
C	Door Contact
MD	Motion Detector
M	Medical Assistance Call Device
P	Duress Assistance Call Device
T	Temperature Monitor
▽	CCTV Camera Location

<b>UNIVERSITY OF ARIZONA</b>		
<b>MANUAL OF DESIGN SPECIFICATION STANDARDS</b>		
STANDARD DETAIL:		
ACCESS AND SECURITY SYSTEMS SYMBOLS LIST		
DRAWN BY: KML	DETAIL NO.	REVISIONS
APPROVED BY: FD&C	C6-D8	..
ACAD: C6-D8		..
		..
		..

## TAB C-7

### ROOM NUMBERING

Obtain building number, address, and room numbers from Real Estate Administration at 621-1813.

All drawings issued for construction shall contain and reference accepted room numbers so that electrical panels, telephone backboards, air distribution devices, as-built information, balance reports, etc. will not have to be cross referenced or revised after occupancy of the space.

Renovation projects shall maintain the same room numbering sequence which presently exists within the building. Obtain a current key plan for the building and fit new room numbers into the existing scheme and the following protocol. Secure acceptance of room numbers from Real Estate Administration before proceeding with any drawing schedules.

New buildings and additions shall generally adhere to the following room numbering protocol:

All room numbers shall consist of 3 primary digits.

The first digit shall identify the floor level. The ground floor is always level 1. Multiple basement levels will have to be treated as a special case.

The second and third digits shall be used to sequentially identify rooms on a floor level (01 to 99).

A fourth digit may be employed as a prefix to describe an independent building within a cluster or a sizable addition (i.e., N118).

From the elevator or main floor access; room numbers shall be assigned sequentially in a clockwise fashion left to right. Even numbers shall be used on the right hand side of the corridor and odd numbers on the left hand side. (When walking from the elevator or main floor access.)

Corridors shall be identified by a large even number and a suffix indicating the direction in which it runs (i.e. 500W).

Room numbering shall be assigned so as to allow for future room additions (i.e., spread the numbering system out so that infill numbers are available, based on available space).

An effort shall be made to maintain consistent room numbers for similar elements on each floor (i.e., if bathrooms are located in same area of each floor they should share common room number ending digits).

Rooms within a room (second order) shall be consecutively labeled alphabetically in a clockwise manner from left to right (i.e., 118A, 118B etc.). Additional rooms (third order) shall be sequentially numbered similarly (i.e., 118A1, 118A2 etc.).

Open vestibules and alcoves shall not be assigned permanent room numbers.

Scheduled door number references should match the room number to which it enters.

## TAB C-9

# SURFACE WATER DESIGN GUIDELINES

### Intent

With the continuing development of the campus, the University strives to recognize the long-term inherent value of water by conserving, harvesting, capturing, and reusing it. Within a project's design process, surface water should be an influence on integrated site design promoting proactive solutions that are consistent with or exceed regulatory standards. Given current limited storm sewer and land capacities, combined with a historic reliance on existing streets for surface water conveyance, some of the mitigation of past and future surface water issues at the University of Arizona should occur on a project by project basis. In the interest of fulfilling this intent, two types of design criteria are noted below. The *General Surface Water Guidelines* address issues applicable to all projects while the *Specific Features Guidelines* inform the design intent of specific surface water elements.

### General Surface Water Guidelines

- Preliminary siting studies for the project shall consider information related to the existing drainage conditions of the site, using the most recent campus-wide drainage study as a reference. The preliminary siting studies shall consider, at a minimum:
  - The existing site area and adjacent areas within 500 feet of the project, and include areas which may contribute surface water (watershed) to the proposed site.
  - The general area the site is within, for example, the campus historical core, North Campus, South Campus, etc.
  - Evaluation of existing landscapes, plant palette, formal, informal, historic, ornamental – introduced plants.
  - Evaluation of the contextual setting of the site.
  - Utility (below/at grade) corridors, emergency route, pedestrian and automobile electric cart core circulation routes.
  - Identified project building expansion and proposed expansion adjacent to the project site.
- Whenever possible, site development should not diminish the quality or increase the quantity or rate of surface water flow that leaves the site in its existing condition. Potential increased surface water flows should be mitigated on-site if possible.
- Wherever possible, site development should strive to reduce the quantity and rate of flow at or below the original natural condition of the site through the use of landscape swales and water harvesting.
  - Opportunities for water harvesting should be specifically discussed in conceptual narratives in early design stages. *"The City of Tucson Water Harvesting Guidance Manual, 2005"*, and *"Harvesting Rainwater for Landscape Use"* by Patricia H. Waterfall (University of Arizona Cooperative Extension), should be used as technical references.
- Site development should meet or exceed all applicable regulatory standards. The intent is to meet at a minimum COT stormwater standards (*Standards Manual for Drainage Design and Floodplain Management in Tucson, Arizona*), exceed them where possible, and to demonstrate innovative techniques for which the City may not have applicable standards.
- The *Surface Water Report* described in Tab B-11 of these Design and Specifications Standards and prepared for a project will be based on the format and technical standards of the COT (*Standards Manual for Drainage Design and Floodplain Management in Tucson, Arizona*) but will be tied to the hydrology model used for the most recent UA campus-wide drainage study. This model is consistent with but more detailed than COT models for the campus.
- All construction activities must be in compliance with the current version of the *University of Arizona Stormwater Management Plan*.

- Wherever possible, site development should occur in a way such that all flows exiting the project site remain in the current watershed sub-basin so as to not impact drainage patterns in adjacent watershed sub-basins.
- Flood Prevention: Proposed building ground floor elevations and any apertures into the building should be 1' or more above the 100 year flood plain (modifying this standard is strongly discouraged, but is an option if appropriate floodproofing can be demonstrated). Sunken access ways or patios leading to building levels below the natural grade of the site are not permitted when adjacent to a 100 year floodplain, and discouraged in other areas. Soil should be graded so that water drains away from the building at a minimum of 2%, subject to other site criteria, such as accessibility. Elevations of underground utilities shall be considered in the grading layout.
- Design and construction activity must be in compliance with the current *University of Arizona Stormwater Management Plan* submitted to Arizona Department of Environmental Quality.
- Site development must be done in a way to avoid the following conditions:
  - Ponding of a duration that may allow mosquito breeding
  - Ponding in access ways which may create a nuisance for pedestrians.
  - Ponding within 10' of building foundations (to prevent infiltration that may cause indoor mold or structural problems)
  - Any water catchment not draining within 24 hours
  - Retention facilities not draining within 12 hours.
  - Surface water that is wasted, e.g., by running down the street.
  - Surface water that is routed in a way which inappropriately distributes sediment or chemicals.
  - Channelized or concentrated water conveyed over sidewalks
  - Water running off of irrigated turf areas.
- A determination is to be made as to whether or not construction activity resulting from site development will disturb 1 acre or more. If 1 acre or more is disturbed a Storm Water Pollution Prevention Plan (SWPPP) will be required and an Environmental Protection Agency AZPDES Storm Water Construction General Permit must be secured. The University of Arizona department of Risk Management and Safety may be contacted for guidance in securing this permit and filing the associated EPA Notice of Intent (NOI).
- Storm Sewer Discharges:
  - Water discharged (e.g., storm water, condensate) from sources that must be pumped to a location for conveyance/disposal should not be directed to roadways/hardscape. Such discharges should be directed to planted areas except when the water quality would be detrimental to plants.
  - Storm and surface waters are not candidates for disposal in the Publicly Owned Treatment Works (POTW) or sewer system. Such disposal would constitute "hydraulic loading" and is considered a prohibited discharge by Pima County Industrial Wastewater Ordinance.
  - Manholes are not allowed in low lying areas and/or known watercourses to prevent waters from infiltrating through perforations in the manhole cover.
- Roof Drainage:
  - Roof drainage outlets and landscape surface materials must be designed to prevent landscape erosion.
  - Ponding within 10' of the building edge is prohibited.
  - Roof leaders/scuppers should be of a small enough diameter so as to divide roof runoff into a series of outlets with a low enough volume/velocity that will allow water to be harvested equally throughout the site (i.e., broken into small volumes for smaller basins/swales). Large diameter outlet pipes convey too much water at too high velocity to capture in small-scale landscape swales. Proper clean outs should be provided to allow necessary maintenance of smaller diameter pipes.
  - Bubbler boxes are strongly discouraged but may be used to dissipate the energy associated with larger volume rain leaders. In such cases, the bubblers should be located at least 10' from building foundations (see specific guidelines for bubblers below).

- Ancillary Water Sources Available On Or Near The Site:
  - Water sources such as mechanical condensate, process water, graywater, drinking fountain water, and other sources identified shall be considered as part of passive and active water harvesting systems.
  - Such water may be used, if deemed appropriate, for landscape irrigation, return to central plant for other uses, supplementing water for pools or water features, or other uses to be determined.
- Soils:
  - Testing
    - If possible, soils testing should be conducted at the time of or prior to preparation of the initial draft of the *Surface Water Report* that will be prepared for a project. Such reports should investigate not only structural characteristics but also percolation rates and agricultural soils analysis as it relates to plant growth. Agricultural soils analysis shall be prepared by a certified soils agronomist.
    - A soil percolation test is required after rough grading of major/regulatory detention and retention facilities to verify that site development activities have not negatively impacted percolation rates. If reduction in percolation rate is identified, mitigation may be required.
  - Subsurface preparation
    - Structural soils should be explored for use under large expanses of hardscape or other areas with limited percolation.
    - Soils beneath/adjacent to french drains, bubbler boxes, and other sub-surface structures should be over-excavated and replaced with an engineered soil designed to absorb or accept water.
  - Compaction
    - Soil beneath the bottoms of all water harvesting areas should be loosened to a depth of at least 18" prior to trenching and installation of irrigation lines.
    - Specified compaction required for buildings, streets, and other structures shall be maintained within specified distances around such structures. Beyond these compaction zones, soil should be loosened to a depth of at least 1' prior to planting within all landscaped areas.
    - All construction debris and waste material must be removed from the soil within landscape and basin areas.
    - Acceptable limits of compaction must be maintained through completion.
  - Soil Grading: The finished grade of all landscaped areas should be recessed downward from adjacent paved surfaces to create water harvesting catchments. Maximum reveal at edge of pedestrian circulation paving shall be 1" to minimize the risk of injury. A 12" – 18" level shoulder area to the paved surface shall be maintained. The shoulder area shall have a 1% - 2% cross slope away from paving directed to water harvesting/basin areas.
  - Ground Cover Materials:
    - Within areas conveying significant storm flows, ground surfacing should consist of a material that is able to withstand scouring. This includes hardscape paving, rock mulch, graded or sized rock, rip rap, fractured rock, and turf in some situations. Bare soil, decomposed granite, or other loose forms of mulch are not suitable for this application. Filter fabric placed with 12" minimum toe downs at edges shall be used under all rock, mulch, and rip rap within conveyance areas.
    - Rip Rap: Where required, utilize a rough, non-angular, weathered Catalina granite incorporating a spectrum of tan and gray colors. Alternatives will be considered based on justifications for the specific application (samples should be provided by design professionals). Filter fabric should be included under rip rap used for erosion protection in a conveyance channel, and any gaps in rip rap shall be fully filled with pea gravel or sized/graded rock that is swept in the gaps to prevent erosion.
    - Fine grades of decomposed granite should not be used within or adjacent to basins or water harvesting areas. Landscape areas which shed water rather than capture it should receive ½"+ crushed gravel with no fines, preferably with a mixture of sizes and some color variation to reflect the native desert surface.
    - The bottoms of landscaped basins should receive ¼" pea gravel or ½"-1" sized/graded crushed rock that has been washed to remove all fines or organic mulch.
    - Colors samples of all proposed rock types shall be submitted for approval.
    - Organic mulch is encouraged in locations where the vegetation, water collection, erosion, and slope characteristics make it appropriate.

- Turf, as a surface material in large regulatory basins, is only permissible when combined with a low-flow landscaped area which allows a majority of the turf to drain within a short time. It is preferable to utilize turf predominantly on the bottom rather than sides of large basins for ease of irrigation and mowing and to allow the turf to be watered by sheet-flow runoff. Based on project-specific considerations, turf panels may include a shallow retention catchment (6" or less) which shall include a prepared soil bed that will rapidly absorb retained rainfall. Extensive sub surface soil preparation will be required for turf in basins which collect greater volumes.

### **Specific Features Guidelines for Drainage and Water Harvesting**

The following guidelines are intended to inform the design of specific surface water features when they are included in a project. Note that the Design and Specifications Standards (DSS) include specific guidelines for Water Features and for Wells in other sections. This section of the DSS includes guidelines for the following features:

- Water Storage Features
  - Water Harvesting Micro-Basins
  - Regulatory Detention / Retention Basins
  - Sumps
  - Dry Wells
  - French Drains and other Subsurface Structures
  - Structural Soil
  - Bubbler Boxes
  - Sidewalks
  - Storm Sewers
  - Area Drains
  - Infiltration Chamber
  - Permeable Paving
- Water Storage Features
    - Guidelines for all types of water storage cisterns:
      - Access points into the cistern must be secured for safety
      - Openings must be sealed or screened to prevent mosquito breeding
      - Light must be prevented from entering to prevent biological growth
      - A method for using/distributing the water must be designed into the system.
      - Projects which include cisterns are encouraged to explore all available sources of water to be captured, including rainwater, condensate, and other sources unique to the location.
    - Underground water storage cisterns:
      - Underground cisterns may be used where a very large volume of water is being stored or where there are no appropriate surface level sites available.
      - Water stored in underground cisterns may be allowed to infiltrate or bleed off, although the preference is for this water to be stored and utilize for landscape irrigation. In such cases, pumping and filtering mechanisms must be included.
    - Above ground exterior water storage cisterns:
      - Above ground cisterns are appropriate for smaller volumes of water and where the storage structure may be appropriately integrated into the landscape.
  - Water Harvesting Micro-Basins
    - General Guidelines for Design of Water Harvesting Micro-Basins:

- The depth of a micro-basin should be sized according to the anticipated volume of water that will enter the basin, taking into consideration whether the basin will only collect water falling on the basin area or if it will be intercepting flows from adjacent watersheds.
  - The edge of any ponding within microbasins should be 10 feet from building foundations. Closer placement may be possible with the approval of a soils professional and may include structural soil backfill with protective liner at the foundation.
  - Micro-basins should be designed so that water infiltrates the soil within 12 hours.
  - Unpaved or planted areas should be sunken below the grade of adjacent hardscape to create micro-basins wherever possible. Pedestrian circulation should be designed to discourage cutting across basins so as to avoid compaction, erosion, and damage to plants.
  - Conveyance swales should incorporate check dams and/or nested micro-basins to slow and harvest water and trap sediment.
  - Water should be harvested and slowed near its source to avoid the need for larger catchments downstream.
  - The *City of Tucson Water Harvesting Guidance Manual* should be used as a technical reference.
  - The design/placement of micro-basins shall “co-evolve” with the planting design so that plantings will take maximum advantage of harvested water.
  - In larger, open, landscape areas not constrained by adjacent hardscape, a series of interconnected small basins (5’ to 15’ wide) terraced into the landform should be included. Additional smaller basins which correspond to planting patterns are generally preferred over fewer large basins. Where included, a concept diagram for such interconnected basins is to be provided in the Surface Water Report.
  - The arrangement, contouring, sequence, and form of micro-basins should take on a natural character unless the form of the adjacent hardscape, or an approved overarching artistic concept, suggests more formal or otherwise less-organic forms are appropriate. Earthworks within small, narrow areas should generally include simple, function forms due to the limited area to vary the pattern.
  - Plants selected for use in microbasins shall have compatible water needs. Other considerations shall include sun exposure, maintenance requirements, shape, form and aesthetics. Certain plant forms may work better in informal vs. formal planting designs. Consideration shall be given to the area of campus (historical core, AHSC, etc.) when selecting plants. Plants shall be used to create a seamless transition from new improvements/building projects and the existing adjacent landscape. Plants with differing water needs shall be irrigated and controlled separately. Irrigation system shall be capable of monitoring plant water needs through the use of soil moisture gauges and weather station data.
- Drawing Standards for Water Harvesting Micro-Basins:
    - Micro-basin details shall be developed and referenced in all planted or non-paved areas on both the landscape and civil drawings. Below are standards to be used in preparing required drawings which describe in graphic and text form water-harvesting micro-basins.
      - Plans:
        - A 10’ setback line from buildings is to be shown on the grading plan indicating the limits of allowable ponding.
        - The design of paved or circulation areas should, wherever possible, slope the hardscape/surface toward micro-basins. All paving adjacent to micro-basins shall be labeled with arrows indicating a slope toward the micro-basins.
        - RipRap shall be indicated on appropriate drawings for micro-basin slopes where required.
        - The level, flat bottoms of micro-basins shall be shown on civil/grading *and* planting plans with a hatch pattern. Spot elevations shall be shown on the grading plan to indicate the elevation of the flat bottom area.
        - The location of any french drains within micro-basins must be indicated on civil/grading plans.
        - For micro-basins accepting water from adjacent watersheds/basins or overflowing into adjacent watersheds/basins, the location of inlets/outlets/spillways shall be indicated on the civil/grading plans along with flow arrows. Rip rap needed for erosion protection shall be shown at inlets/outlets. Volume calculations shall be provided where necessary.



- Details/Notes: A detail or series of details with accompanying notes that reflect the following standards for micro-basins shall be prepared.
  - The edge of ponding in micro-basins should be a minimum 10' setback from any building.
  - Adjacent to hardscape, there should be a minimum flat area 12" wide of compacted soil before beginning the sideslope of a micro-basin.
  - Basin sideslopes should vary, but be no greater than 3:1. Variation in slope is desirable to create undulations in the form of basins.
  - Sideslopes and berms which form the edge to micro-basins should be compacted.
  - Slopes steeper than 4:1 may require rip rap depending on surface flows, erosion potential, and circulation patterns.
  - Micro-basin bottoms should be level, with flat areas as large as possible while not causing sideslopes to exceed 3:1 .
  - When proposed planting areas are bound by hardscape at different elevations, micro-basins are to be included for these planting areas as long as a catchment area can be achieved which is at least 1' wide (flat bottom) by 2" deep (while not creating sideslopes steeper than 3:1).
  - Micro-basin flat bottoms shall be excavated/loosened to a depth of at least 18" beneath the finished grade of the basin bottom. This shall be done at the time of rough grading and prior to trenching for irrigation lines. Loosened soil should be re-compacted beneath new tree root balls. Note that by following all guidelines in this section, basin bottoms should be far enough away from fixed structures so that minor settling of the soil should not have any negative impacts.
  - French drains are encouraged within the bottoms of micro-basin to promote infiltration of water when contributing flows from adjacent watersheds warrants a greater holding capacity. Micro-basin french drains must be longer than they are deep and the bottom of the french drain must be no more than 3' beneath the basin bottom so as to keep the water within the soil root zone of plants. If french drains are proposed, discrete details must be prepared for them.
  - For a micro-basin accepting flows from adjacent watersheds, the basin bottom should generally be no deeper than 18" below the basin spillway or rim (greater depth is acceptable if there is an outlet at 18" or less). For a micro-basin only receiving rain falling directly within it, typical depths should range from 4" to 8".
  - Rip rap is to be included for erosion protection at spillways.
  - The bottoms of micro-basins should receive ¼" pea gravel, or ½"+ crushed gravel that has been washed to remove all fines, including gravel dust. Micro-basin bottoms may also receive organic mulch.
  - If a series of small interconnected or terraced basins are included in the design, the horizontal, vertical, and flow relationship between them should be documented in one of the details.
  - Typical planting details (shrub, tree) are to be shown in the level bottom and side slope terraces in the micro-basin details, with appropriate grade transitions shown. For trees, indicate the rootball sitting on undisturbed native soil with top of rootball level with a terrace 4"-12" above the finished flat bottom of the basin. Indicate a mulch layer within this terrace which does not bury the trunk. In no circumstances shall there be a low area for water to pond directly around the trunk of the tree.
  - Excess soil removed from planting holes must not be spread or disposed of within micro-basins.
  - Include a note that all micro-basin grading must be complete and inspected prior to planting and again prior to application of mulch.
- Regulatory Detention / Retention Basins
    - Mitigation of Regulatory Storm Flows with Surface Basins
      - Basins should be designed for multiple-use (i.e. drainage, active and passive recreation, landscape aesthetics, and circulation). Basins should be designed as a collaboration between the project Landscape Architect and the Civil Engineer, with input from other team professionals. The basic land forms and site characteristics should be laid out in concept form by the Landscape Architect. The preliminary basin design will be approved by the University prior to detailed hydrologic modeling by the Civil Engineer.
      - Smaller non-turfed basins can be used for passive type use such as sitting areas. Site amenities such as benches can be built in or incorporated in the design of the basin area.

- Universal access should be provided to basins to the greatest extent possible using functionally and visually integrated structures.
  - Flows from land uses which are likely to generate pollutants (such as parking lots) should route water in a way that isolates the first flush runoff in discrete catchments so as to limit the spreading of contaminants and to make future clean up easier.
  - Routing of flows between micro-basins or larger basins should be done in a way to slow flows for increased absorption and reduced erosion.
  - The following characteristics should be designed for turf basins to insure quick draining into a landscaped low-collection area.
    - Minimum bottom slope of 1% for turf
    - Sub-surface should be prepared to a minimum of 18" below imported soil for the turf.
    - Low-flow collection areas should not be in the low point of turf. The lowest turf areas should drain to landscaped collection areas, allowing the turf to dry out as soon as possible following the rain.
  - Landscaped (non-turf) basin bottom surface: Round pea gravel or ½" to 1" sized/graded crushed rock is to be used in basin bottoms.
  - Basin form: Single-use storm water catchment basins typically derive their form based on simplified patterns which are easy to translate into a storage volume, and are therefore easy to model. Such forms are generally incompatible with the type of multi-use open space basins desired on the University campus. Therefore, basin side slopes should vary (i.e., the horizontal distance between contours should vary) in response to aesthetic and multi-use design objectives of the project. During concept design, water storage calculations corresponding to desired mitigation goals are to be converted into gross volumetric dimensions and then provided to the project Landscape Architect for use in designing the basin form. The resulting form will then be modeled by the project Hydrologist in order to provide feedback about adjustments which may be needed in the size/form of the basin to achieve storm mitigation goals. Several such iterations of design refinement may be required to achieve a satisfactory result.
  - Basin side slopes: Side slopes should be a maximum of one unit of vertical change for every three units of horizontal change.
  - Retention basins must demonstrate ability to drain within 12 hours, based on soil tests.
  - Low flow metering/outletting to bleed off detained water should be proposed for basins which percolation testing has shown will not drain within 12 hours (otherwise a plan must be proposed for ongoing pumping).
  - Weirs / outlets / inlets should be designed as integral elements of the landscape as opposed to purely functional conveyance structures
- Mitigation of Regulatory Storm Flows with Subsurface Storage tanks:
    - Subsurface storage tanks include various systems to hold water underground and are conceptually similar to underground cisterns (see above), with the difference being that subsurface storage tanks are sized to accommodate or mitigate flow volumes corresponding to major storm events.
    - Guidelines noted above for underground cisterns apply to subsurface storage tanks.
- Sumps
    - Water collected in site/building sumps: Sumps which collect water running off into courtyards or other non-draining areas should be designed to pump the water into landscaped areas configured for water harvesting, or into an adjacent irrigation system. Sump water which may contain unique pollutants, sediments, or other elements making it unsuitable for irrigation may require special provisions for disposal.
    - Discharge of sump water shall not be to surface streets or storm sewers.
  - Dry wells
    - Drywells are defined by the Arizona Department of Environmental Quality (ADEQ) as: "A drywell is a bored, drilled, or driven shaft or hole with a depth that is greater than its width and that is designed and constructed specifically for the disposal of stormwater (Arizona Revised Statutes (A.R.S) 49-331(3)).
    - Drywells shall be considered only as a last resort for the distribution or disposal of surface/storm waters.

- French Drains and other Sub-Surface Structures
  - French drains are encouraged in larger volume harvesting/detention areas where adequate soil percolation may be in question.
  - French drains must be wider than they are deep.
  - Rock backfill in drains may be wrapped with filter fabric depending on the intent of the drain.
  - Perforated pipe may be placed in the trench to facilitate the movement of water throughout the length of the drain.
  - French drains can be routed through planted areas to maximize using rainwater to supplement irrigation.
  - The intent of French drains is to dispose and disperse water throughout soil within the root zone.
  - The bottom is to be no deeper than 10' beneath the finished surface grade. A maximum depth of 3' is desirable in planted areas so as to keep water within plant root zones.
  - Other sub-surface structures intended to disperse water into the soil root zone, such as infiltration chambers shall be evaluated on a case-by-case basis.
  
- Structural Soil
  - Structural soil is a specialize soil mix involving a coarse aggregate, organic and non-organic soil components, and a binder which creates a structural sub-grade sufficient for heavy load paving, while also providing the air and water flow needed within the soil for root growth.
  - Structural soil shall be utilized to increase the viable root growth zone for trees planted within large expanses of hardscape.
  - Water collected/shed from adjacent hardscape shall be directed into the structural soil via surface flows to planter cut-outs, area or roof drains which empty directly into the soil matrix, or through permeable pavement.
  
- Bubblers boxes
  - Bubbler boxes are designed to overflow, therefore, they do not meet the definition of a drywell (they are for conveyance, not disposal).
  - All bubbler boxes shall be constructed to have porous, draining bottoms, and the soil beneath bubbler box units must be prepared in such fashion to support percolation.
  - All bubbler box systems shall be constructed to drain their full volume with 24 hours.
  - Bubbler boxes shall be designed to minimize clogging, silting, and calcification, and shall be easy to clean.
  - Bubbler box systems shall drain into one or a combination of recessed turf areas, landscaped water harvesting microbasins, or areas of structural soil.
  - The design shall be configured to allow pumping if needed over the long term. In the event pumping systems are required, pumping durations shall be to be limited so as to not impact landscapes.
  
- Sidewalk Scuppers/Trench Drains
  - Water from roof drainage outlets, channels and swales must not be routed across sidewalks.
  - Scuppers, drain pipes or trench drains should be used to convey this water beneath walks or paths. Provide rock mulch or rip rap at inlet and outlet as needed to control erosion.
  - It is preferable to route water under walkways in a way that does not interrupt the continuity of the walkway surface material (as happens when steel plate is used). If walkway surface material is interrupted, trench drains may be used as a design element in the hardscape.
  - Sheet flow conveyance across sidewalk surfaces is to be minimized wherever possible by capturing as much runoff as possible in adjacent water harvesting microbasins.
  
- Storm sewers
  - Campus storm sewers are to be designed using City of Tucson standard details unless alternative direction is provided.
  
- Area Drains
  - Drains collecting water within confined spaces which do not discharge flows via the natural grade shall be constructed so as to accommodate all flows which may reasonably be expected to enter the drain system during a 100 year storm.

- This shall include consideration of flows originating beyond the extents of the immediate project (e.g., an adjacent 100-year floodplain) which may enter the immediate area during a large storm event.
- Infiltration Chambers
  - Infiltration chambers are recommended in situations where surface catchment is limited or localized flooding is likely due to lack of a natural outflow path. Chambers should be designed to percolate water into the soil root zone.
- Permeable Pavement
  - Permeable paving includes a variety of surfaces which withstand pedestrian and/or vehicular loads and wear, and permit infiltration of water and air into the subgrade.
  - Permeable paving must be installed with an appropriate subgrade which will allow absorption and/or draining of subsurface water to another location. If there is vegetation adjacent to the permeable paving, a Structural Soil subgrade should be used to allow water absorption into the soil. If there is no adjacent vegetation which would benefit by the water being deposited in the soil, a sub-surface drain system should be included which moves the water to adjacent planting areas.

References:

<sup>1</sup>*City of Tucson Standards Manual for Drainage Design and Floodplain Management in Tucson, Arizona 1989*

<sup>2</sup>*Stormwater Detention Retention Manual for Pima County Department of Transportation & Flood Control District and the City of Tucson, 1987*

<sup>3</sup>*City of Tucson Water Harvesting Guidance Manual, 2003*

<sup>4</sup>*University of Arizona Master Drainage Study, 1997*

<sup>5</sup>*University of Arizona Stormwater Management Plan*

<sup>6</sup>*Harvesting Rainwater for Landscape Use, 1998*

## TAB C-11

# ACCEPTABLE INDOOR AIR QUALITY PLANNING, DESIGN, AND CONSTRUCTION CRITERIA

### CODES AND STANDARDS

- ANSI/AIHA Z9.5-1992: American National Standard for Laboratory Ventilation
- ASHRAE Standard 62-1999: Ventilation for Acceptable Indoor Air Quality, 1999
- The University of Arizona Manual of Design and Specification Standards (MDSS)
- SMACNA: IAQ Guidelines for Occupied Buildings Under Construction, First Edition, November, 1995

### A. DESIGN

Purpose: To facilitate communication and improve understanding of indoor air quality issues among members of the design team and between the design team and the University and provide the basis for evaluating indoor air quality issues and the performance of the HVAC system during the commissioning process.

1. Identify and document all heating, ventilating, and air conditioning (HVAC) system design requirements, assumptions, and criteria. The following information shall be provided:
  - 1.1 Indoor design conditions for each building space:
    - a. Temperature
    - b. Relative humidity by season
      1. Maximum space humidity during all seasons: 50%
    - c. Pressure relationship between adjacent areas
  - 1.2 Outdoor design parameters:
    - a. Dry bulb and wet bulb temperatures
    - b. Relative humidity
    - c. Prevailing wind direction by season
  - 1.3 Building space information:
    - a. Type
    - b. Occupancy densities
    - c. Activities
    - d. Use patterns
  - 1.4 Internal loads for each building space:
    - a. Lighting
    - b. Equipment
    - c. People
    - d. Infiltration
    - e. Any special or unusual electrical, thermal, or moisture loads
  - 1.5 Any odorous or hazardous pollution sources for which additional measures, e.g., local exhaust, additional dilution ventilation, are required.

- 1.6 Criteria utilized to determine outside air requirements for each building space.
    - a. Minimum outside airflow rates shall be clearly indicated on design drawings.
  - 1.7 Classification of air assumptions for exhaust and recirculation air streams shall be in accordance with Appendix A.
  - 1.8 Air cleaning and filtration efficiencies and filter area.
    - a. Filter area shall be clearly indicated on design drawings.
  - 1.9 Means by which outdoor air quality has been assessed and outdoor air contaminants of concern (if any) and air filtration requirements determined to establish outdoor air intake location(s).
    - a. The building site shall be surveyed for sources of contaminants (health, odor, or sensory irritation contaminants).
  - 1.10 Criteria used to determine locations of air devices (e.g., supply, return, exhaust, etc.) to ensure proper dilution and mixing of air within each building space.
  - 1.11 Means by which and locations where outdoor air can be measured and balanced.
  - 1.12 Means by which temporary exhaust can be provided in the future to control strong source contaminants during shell space construction. For further information, refer to Appendix B.
  - 1.13 Applicable codes, standards, regulations, etc.
  - 1.14 Narrative describing the design and operation of the HVAC systems during occupied and unoccupied periods.
  - 1.15 Description of HVAC system control sequence of operation and identification of control system setpoints.
  - 1.16 Minimum and maximum flow rates for terminal units.
  - 1.17 Description of building envelop construction, including locations of vapor and air retarders.
  - 1.18 HVAC calculations, including cooling load, heating load, and exhaust flow rate calculations.
2. Integrate prudent design principles and features as indicated in the following paragraphs.
- 2.1 Locate outdoor air intakes away from known sources of contaminants, including, but not limited to, exhaust and vent outlets, plumbing stacks, emergency generator exhaust stacks, loading dock areas, flue stacks, and areas where people might congregate to smoke. For further information, refer to Appendix C.
    - a. Preferred location of outdoor air intakes is above roof level.
    - b. Outdoor air intakes should preferably not be located at ground level.
  - 2.2 Locate exhaust and vent outlets away from operable windows and doors and property line. For further information, refer to Appendix D.
  - 2.3 Bird screens shall be located over outdoor air intakes.
    - a. Bird screens shall be constructed of galvanized or stainless steel. Bird screens shall be ¼-inch mesh.

- b. Bird screens shall be accessible for cleaning.
- 2.4 Outdoor air intakes shall be protected from rain entrainment by louvers, mist eliminators, or rain hoods. For further information, refer to Appendix E.
- 2.5 Recirculation of air (for further information, refer to Appendix A):
- a. Recirculation of Class 1 air is allowed.
  - b. Recirculation of Class 2 air within the same room is allowed; recirculation of Class 2 air is allowed in other rooms if particulates are filtered or the air is sufficiently diluted with Class 1 air.
  - c. Class 3 air can only be recirculated within the same room.
  - d. Class 4 air can be exhausted or recirculated if the air is filtered to Class 2 air criteria.
  - e. Class 5 air must be exhausted.
- 2.6 Provide access doors to the following components for inspection and cleaning purposes: outdoor air intakes or plenums; upstream and downstream surfaces of cooling and heating coils; air washers; evaporative sections and coolers; other heat exchangers; air cleaners; drain pans; fans, filters, damper sections, humidifiers; and air flow measuring stations (other than unit flow sensors).
- a. Access doors shall be factory-fabricated, readily openable, and airtight.
  - b. Access doors shall be clearly indicated on the design drawings.
  - c. Access doors shall be clear of all obstructions and provide full access.
  - c. Air handling unit access doors shall be full man-doors or as large as equipment will allow.
  - e. Ductwork access doors shall be as large as ductwork will allow. If possible, ductwork access doors shall have a minimum size of 18-inches by 18-inches; 24-inch by 24-inch access doors shall be provided where possible. Hard ceiling or wall access doors shall be fire-rated and have a minimum size of 24-inches by 24-inches.
- 2.7 Air handling equipment shall be designed for no water droplet carryover. The MDSS requires air-handling equipment to have draw-through cooling coils having a maximum face velocity of 400 fpm properly and evenly distributed across the face of the cooling coil.
- 2.8 Drain pans shall be pitched towards the drain and shall be appropriately trapped. For further information, refer to Appendices F and G.
- 2.9 No internal exposed thermal insulation is permitted except as allowed by the MDSS.
- a. Supply ductwork shall be wrapped on its outside surface with thermal insulation in accordance with the MDSS.
  - b. Internal exposed thermal insulation shall not be installed in medical areas, clean rooms, or high velocity ductwork.
  - c. Internal exposed thermal insulation may be used in acoustically critical applications where the University's written permission has been obtained.
  - d. If permitted, internal exposed thermal insulation shall be elastomeric closed cell, cleanable, non-biodegradable, impermeable to water and moisture, and secured with welded pins and non-flammable adhesive. Internal exposed thermal insulation must have metal nosing or sleeves over leading edges at fan discharge, around access door openings, and at any point where the insulation is preceded by internally uninsulated duct. Internal exposed thermal insulation shall be kept away from intake screens, mist eliminators, louvers, and rain.
- 2.10 Air handling equipment and ductwork shall not be constructed of porous or semi-porous materials, e.g., concrete masonry units (CMU) or gypsum wallboard (GWB).
- 2.11 Potable water shall be used in direct evaporative humidifiers, air washers, and evaporative coolers.

- 2.12 Provide humidification only when absolutely necessary or when it is a special project requirement.
  - a. Utilize steam-to-steam-type humidifiers only.
- 2.13 Provide continuous water bleed or automatic periodic drain combined with chemical water treatment to control scale and microbial growth in air handling systems designed to recirculate water from an open storage tank or sump of an evaporative cooler, air washer, or evaporative section of air handling equipment.
  - a. If water treatment chemicals are used they shall not enter the air stream or must be acceptable for use in evaporative equipment and approved for this use by the University's Risk Management & Safety Department. To determine the acceptability of water treatment chemicals, contact the National Antimicrobial Information Network at 1-800-447-6349.
- 2.14 Filters shall be selected as appropriate for the application. For further information, refer to Appendix H.
  - a. Filters for air handling equipment whose flow rate exceeds 4,500 cfm shall have a minimum sixty percent (60%) efficiency pre-filters and final filters with 80-85% minimum efficiency when passing a three (3) micron particle.
  - b. Filters for all other air handling equipment shall have a minimum efficiency of sixty percent (60%) when passing a three (3) micron particle.
  - c. Filter area shall be based on 400 fpm face velocity.
  - d. Filter rack shall be constructed to allow no bypass of air.
- 2.15 Supply ductwork located in a return air plenum, chilled water supply and return piping, and domestic cold water piping below 55 degrees F shall be properly insulated to prevent condensation from forming. For further information, refer to Appendix I.
- 2.16 Insulation subject to damage or a reduction in thermal resistivity if it were to become wet shall be enclosed in a vapor retarder.
- 2.17 Outdoor air intake controls shall maintain no less than ninety percent (90%) of the design outside air flow rate at all times. For variable air volume (VAV) systems, refer to Appendix J.
- 2.18 Air handling system controls shall include an "optimum start-stop" provision to ensure that acceptable temperature, humidity, and ventilation is provided prior to daily space occupancy. For further information, refer to Appendix K.
- 2.19 Carbon dioxide (CO<sub>2</sub>)-based demand control ventilation may be used, but must have a minimum outdoor air flow rate to control building sources. Refer to ASHRAE Standard 62-1999, paragraph 6.3.1 and Appendix D, "Rationale for minimum Physiological Requirements for Respiration Air Based on CO<sub>2</sub> Concentration" to determine the minimum outdoor airflow rate per person required for a specified CO<sub>2</sub> concentration.
- 2.20 Construction of the building envelope shall comply with all applicable code requirements relating to the control of water and water vapor penetration, air filtration, and entry of radon and other soil gases.
- 2.21 HVAC systems shall be designed to provide at all times no less than the minimum total amount of outdoor air required for ventilation by Table 2 of ASHRAE 62-1999.



- 2.22 Zone minimum airflow rates shall provide minimum outdoor air ventilation airflow rates during space occupancy.
- 2.23 Mechanical rooms shall not be used as air plenums. Air routed through mechanical rooms shall use hard ductwork only.
- 2.24 Utility fans serving fume hoods shall have a 3,000 feet per minute minimum discharge velocity in a vertically upwards direction and shall discharge at a minimum of ten (10) feet above the adjacent roof line. For further information, refer to ANSI/AIHA Z9.5.
- 2.25 Direct evaporative cooling may be used in air handling equipment only after the University's written permission has been obtained.
- 2.26 Direct evaporative cooling equipment:
  - a. Must limit space relative humidity to less than fifty percent (50%).
  - b. Must have no filter bypass.
  - c. Must be completely accessible, both upstream and downstream, for inspection and cleaning.
  - d. Must have no water droplet carryover. Manufacturers' recommendations for maximum allowable face velocities must be followed.
  - e. Must have filters upstream that have a minimum sixty- percent (60%) efficiency when passing a three-(3) micron particle.
  - f. Must have a water treatment system to prevent scale formation and anti-microbial growth that utilizes potable make-up water, blowdown, and water treatment chemicals.
  - g. Must use water treatment chemicals that do not enter the air stream or must be acceptable for use in evaporative equipment and approved for this use by the University's Risk Management and Safety Department. To determine the acceptability of water treatment chemicals, contact the National Antimicrobial Information Network at 1-800-447-6349.

## **B. CONSTRUCTION**

Purpose: To ensure that work procedures and appropriate controls are utilized to minimize degradation of building indoor air quality during construction, renovation, remodeling, and maintenance activities.

### **1. Initial Planning**

- 1.1 The party responsible for construction, renovation, remodeling, and/or maintenance activities must prepare a plan that addresses how indoor air quality issues will be handled during these activities.
  - a. If the activity only involves University staff, the responsible party will be a University department, e.g., Facilities Management, Facilities Design and Construction, Space Management, etc.
  - b. If the activity involves an outside consultant, the responsible party will be the consultant.
  - c. The University department or consultant shall contact and consult with the University's Risk Management & Safety Department during plan preparation.
  - d. The plan must be approved by the University's Risk Management and Safety Department prior to the beginning of construction.
- 1.2 The plan shall include the following information at a minimum.
  - a. Identification of potential work-related airborne contaminants, e.g., dusts and odorous or hazardous substances.
  - b. Identification of how contaminants may spread through the building.

- c. Identification of how building occupants will be affected by the spread of such contaminants.
    - d. Identification and selection of feasible, specific control measures to keep dusts and odorous and hazardous substances out of occupied areas. These measures could include work area containment, modification of HVAC operation, reduction of emissions, intensification of housekeeping, rescheduling of work hours, moving occupants, defining re-occupancy criteria, etc.
- 2. Isolation of major construction, renovation, remodeling, and maintenance activities in occupied buildings. For further information, refer to Appendix L.
  - 2.1 Affected areas in occupied buildings shall be isolated from adjacent non-affected areas through the use of temporary walls, plastic sheeting, or other vapor retarding barriers.
  - 2.2 Affected areas shall be maintained at a negative pressure relative to surrounding non-affected areas.
  - 2.3 Recirculating air ducts shall be temporarily capped and sealed. If particulates are the only indoor air quality concern, appropriate filters may be used in place of capping and sealing the ducts.
- 3. Protection of the building HVAC system from dust and moisture during major construction, renovation, remodeling, and maintenance activities in occupied buildings.
  - 3.1 Supply air systems shall not be operated without filters in place.
    - a. Filters shall have a minimum sixty- percent (60%) efficiency when passing a three- (3) micron particle.
  - 3.2 Building materials subject to degradation from ambient environmental exposure shall be protected and replaced if damaged.
    - a. Air handling equipment and ductwork shall be stored in a clean, dry location prior to installation and openings shall be securely covered to prevent entry of dust, moisture, and general construction debris and dirt.
  - 3.3 In new construction air-moving equipment shall be used to "flush" the building to reduce off gassing of interior furnishings and finishes a minimum of 48 hours prior to building occupancy. For further information, refer to Appendix M.
    - a. Temporary filters shall be utilized in the air handling equipment during this period.
    - b. Filters shall be replaced after the flushing of the building has been completed.
    - c. Filters shall have a minimum sixty- percent (60%) efficiency when passing a three- (3) micron particle.
- 4. Notification of building occupants of major construction, renovation, remodeling, and maintenance activities.
  - 4.1 Notify potentially affected building occupants of planned work via Facilities Management's alert notification procedure. A brief description of the work and the precautions that will be taken to protect the occupants' indoor air quality shall be included.
- 5. Substitution of equipment and/or materials:
  - 5.1 Substitution of equipment and/or materials that may affect the HVAC system or its ability to maintain acceptable indoor air quality shall be reviewed by the University for consistency with

documented design criteria.

5.2 Requests for substitution of equipment and/or materials shall be made in accordance with the requirements of Section 01600, Material and Equipment, of the MDSS (refer to MDSS tab D, Boilerplate).

6. Ongoing management after work has begun:

6.1 Specifications shall be monitored and enforced.

6.2 Periodic updates on progress shall be provided to building occupants.

## APPENDIX A

### CLASSIFICATION OF AIR

Return air, transfer air, and exhaust air shall be classified as follows:

**Class 1:** Air drawn from spaces without unusual sources of contaminants such as offices, conference rooms, classrooms, lobbies, retail spaces, coffee stations, storage rooms (except those housing high-emitting products such as paint supplies), equipment rooms such as air handling equipment rooms, elevator machine rooms, individual dwelling units including hotel rooms, and electrical/telephone closets.

**Class 2:** Air drawn from spaces that may have mild contaminant intensity, such as copy rooms, printer rooms, dining areas and break rooms, kitchenettes or dining areas with ovens or other cooking or food dispensing capability such as steam tables, cafeterias, laundry rooms, locker rooms, residential kitchens (general or hood exhaust), limited access non-residential toilet rooms (such as those in office buildings and other spaces not open to the general public), and residential or single toilet rooms and bathrooms (except those to patient rooms of health care facilities). For the purpose of this section, a copy or printer room is a room whose primary purpose is to house copy machines and printers, respectively. Air drawn from a room housing the occasional or personal copier or printer may be considered Class 1 air. [Air exhausted from limited access non-residential toilet rooms are placed in this category because the expected frequency of use of these facilities, combined with the minimum exhaust are rates prescribed in the Design Section 2.21., generally result in exhaust gases that have mild odor intensity. Exhaust from toilet rooms that are publicly accessible, particularly those that are heavily used at times such as in airports, theaters, and other assembly spaces, can be expected to have much higher contaminant concentrations and thus qualify as Class 3 air.]

**Class 3:** Air drawn or vented from locations with significant contaminant intensity, such as nonresidential and public toilet rooms (except those listed above under Class 2), toilet rooms and bathrooms to patient rooms of health care facilities, janitor's closets, commercial kitchens (general and non-grease hoods), laboratories (general exhaust), dry-cleaning processing establishment (general exhaust), indoor swimming pools, diazo printing rooms, and plumbing vents.

**Class 4:** Air drawn or vented from locations with noxious or toxic fumes or gases, such as paint spray booth, garages, tunnels, kitchens (grease hood exhaust), chemical storage rooms, refrigerating machinery rooms, natural gas and propane burning appliance vents, and soiled laundry storage.

**Class 5:** Effluent or exhaust air having a high concentration of dangerous particles, bio-aerosols, or gases such as that from fuel burning appliance vents other than those burning natural gas and propane, uncleaned fume hood exhaust, evaporative condenser and cooling tower outlets [due to possible microbial contamination such as legion Ella, the causative agent of Legionnake's Disease and Pontiac Fever].

## **APPENDIX B**

### **SUPPLEMENTAL EXHAUST**

The design documents shall indicate the means by which supplemental exhaust can be provided to meet the requirements of Construction Section 2.2. This section does not require special systems to be installed since they may be installed on a temporary basis, for example by temporarily removing windows for exhaust fans. Rather, this section requires only that the means be indicated in design documents so that it is available when the need for supplemental exhaust occurs in the future.

It is not uncommon for spaces to be temporarily exposed to strong sources of contaminants, such as during remodeling or after an accidental spill of a volatile liquid. These occurrences may be handled by temporary exhaust systems. In many cases, temporary exhaust is difficult to provide such as, in interior spaces of large buildings. To improve flexibility in future renovations, exhaust systems such as those serving toilet rooms can be designed to include additional capacity that may be manually (or automatically) invoked as needed during the building life. Smoke removal systems might also be used for this purpose if approved by the local fire district.

## APPENDIX C

### LOCATION OF OUTDOOR AIR INTAKES

[This section requires minimum separation distances for outdoor air intakes from known sources of contaminants adjacent to and in the vicinity of the building in order to minimize the introduction of contaminants.] Outdoor air intakes shall be located such that the distance measured from the closest point of the intake opening to the object, or point, listed in Table C1 exceeds the minimum separation distance listed in Table C1. See also Appendix D for restrictions relative to exhaust air outlets.

**Exception:** Shorter separation distances are acceptable if it can be shown that an equivalent rate of introduction of outdoor air contaminants will be attained using an alternative design, and if approved by the authority having jurisdiction.

The distances required in this section are minimums; in general, locating intakes as far as practical from contaminants sources reduces the likelihood of entrainment. Prevailing winds and airflow patterns around the building and building elements may also be important considerations for intake locations.

**Table C1.  
Air Intake Minimum Separation Distance**

Object	Minimum Distance, m (ft)
Property line	1 (3)
Garage entry, loading area, or drive-in Queue (Note 1)	7 (25)
Driveway or street	3 (10)
Limited access highway	7 (25)
Mantels or ledges (Note 2)	1 (3)
Landscaped grade (Notes 3,4)	2 (6)
Roof or grade (Note 4)	0.25 (0.75)
Cooling Towers (Note 5)	5 (15)

**Note 1:** These areas are likely locations where vehicles will be paused and idling, such as while paying parking fees or waiting for traffic in the case of the garage entry, while loading or unloading materials in case of the loading area, or waiting in line for drive-in restaurant or bank service in the case of the drive-in queue.

Larger separation distances may be needed if the intake is located directly above the likely location.

**Note 2:** Applies to mantles or ledges that are sloped less than 45 degrees from the horizontal and that are more than 0.15 m (6 in.) wide. [Such ledges tend to become bird nesting or "resting" places.]

**Note 3:** Landscaped grade is soil, lawn, shrubs, or any plant life within 0.5 m (1.5 ft) horizontally of intake. [The purpose of this section is to minimize the introduction of pollen, odors and vapors from biodegrading materials, pesticides, bacteria, etc. from landscaping.]

**Note 4:** Intake must be at least 0.2 m (8 in.) above the average maximum snow depth at the intake.

**Note 5:** Applies to closest wetted surface of tower, such as intake or basin. See Appendix D for separation distance from tower discharge.

**APPENDIX D**

**LOCATION OF EXHAUST AIR AND VENT OUTLETS**

Exhaust air and vent outlets shall be located no closer to property lines, outdoor air intakes, windows, and doors, both those on the subject property and those on adjacent properties, than the minimum separation distance S listed in Table D1. S is defined as the shortest "stretched string" distance measured from the closest point of the outlet opening to the closest point of the outdoor air intake opening, window or door opening, or property line along a trajectory as if a string were stretched between them. [For example, if a wall separates an intake from an exhaust as shown Th Figure D1 below the distance S is taken from the exhaust outlet in a straight line to the top of the wall over the wall then in a straight line to the intake. In this case, S-S1 + S2 + S3.1

**Figure D1.**

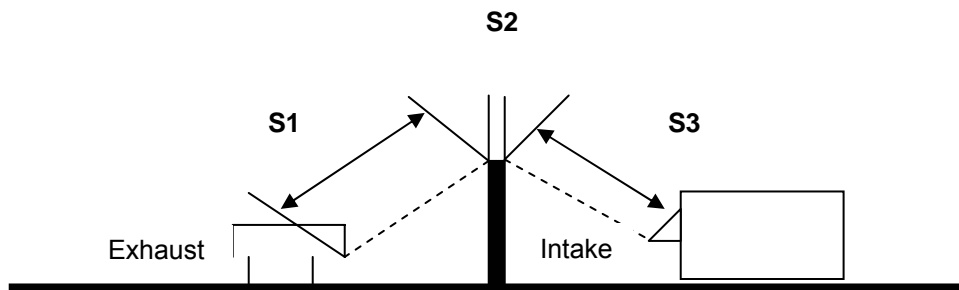

**Table D1  
Exhaust Outlet Minimum Separation Distance (S), M (ft)**

Object	Exhaust Air Class (see Appendix A for definition)				
	1	2	3(Note 1)	4(Note 1)	5(Note 1)
Outdoor air intake	Equation D1	Equation D1	Equation D1 (Note 2)	Equation D1 (Note 2,6)	Equation D1 (Note 2,6)
Operable window or door (Note 3)	0.3(1)	Half of Equation D1 (Note 4)	Half of Equation D1 (Note 4)	Half of Equation D1 (Note 4, 6)	Equation D1 (Note 6)
Property line	0	1.5 (5)(Note 5)	3 (10) (Note 5)	3 (10)	5 (15)

**Note 1:** Laboratory exhaust air outlets shall be in compliance with NFPA 45-1992.

**Note 2:** Class 3, 4 and 5 air outlets that terminate in an equipment well that also encloses an outdoor air intake shall meet the requirements of Table D1 and, in addition, shall either: a) terminate at or above the highest enclosing wall and discharge air upward at a velocity exceeding 5 m/s (1000 fpm); or b) terminate 1 m (3ft) above the highest enclosing wall (with no minimum velocity). For the purpose of this section, an equipment well is an area (typically on the roof) enclosed on three or four sides by walls that are less than 75% free area, and the lesser of the length and width of the enclosure is less than 3 times the average height of the walls. The free area

of the wall is the ratio of area of the openings through the wall, such as openings between louver blades and undercuts, divided by the gross area (length times height) of the wall.

**Note 3:** Operable doors and windows that are required as part of a natural ventilation system shall comply with the row labeled "outdoor air intake."

**Note 4:** Separation distance S is one half of the requirement of Equation D1.

**Note 5:** For Class 2 and 3 air, where the property line abuts a street or other publicway, no minimum separation is required if exhaust termination is 3m (10 ft) above grade.

**Note 6:** For Class 5 exhausts located below intakes or operable windows and doors, distance S in Equation D1 shall be a horizontal separation only; no credit may be taken for any vertical separation.

Where Equation D1 is referenced in Table D1, minimum separation distance S shall be determined as:

$$S = 0.04\sqrt{Q}(\sqrt{D} - V/2) \quad (5-1a) \text{ (SI)}$$

$$S = 0.09\sqrt{Q}(\sqrt{D} - VA/400) \quad (5-1b) \text{ (IP)}$$

Where:

Q = Exhaust air volume, L/s (cfm). The value used in Equation D1 shall not be less than 75 L/s (150 cfm) nor exceed 1500 L/s (300 cfm) regardless of actual volume. For gravity vents such as plumbing vents, use an exhaust rate of 75 L/s (150 cfm). For flue vents from fuel burning appliances, assume a value of 0.43 L/s per kW of combustion input (250 cfm per million Btu/hr) or obtain actual rates from the combustion appliance manufacturer.

D = Dilution factor determined as a function of exhaust air class (see Appendix A) in the table below:

Exhaust Air Class	Dilution Factor, D
1	5
2	10
3	15
4	25
5	50

V = Exhaust air discharge velocity, m/s (fpm). V shall have a positive value when the exhaust is directed 75° to 180° away from the object, and shall have a negative value when the exhaust is directed 0 to 74 towards the object) as shown in Figure D2. V shall be set to 0 in Equation 5-1 for vents from gravity (atmospheric) fuel fired appliances, plumbing vents and other non-powered exhausts, or if the exhaust discharge is covered by a cap or other device that dissipates the exhaust air stream. For hot gas exhausts such as combustion products, an effective additional 2.5 m/s (500 fpm) upward velocity shall be added to the actual discharge velocity.



Figure D2.

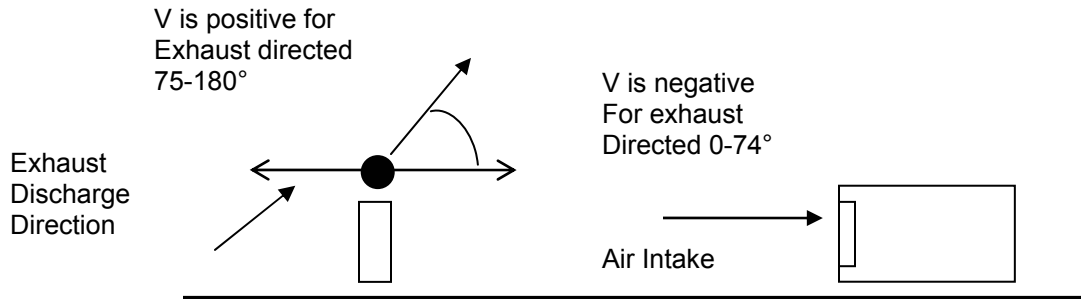

**Exceptions:**

1. Shorter separation distances are acceptable if it can be shown that equivalent dilution factors will be attained using an alternative design, and if approved by the authority having jurisdiction.
2. Outdoor air intakes need not be separated from furnace vents and other fuel-fired appliance vents that are a part of a unitary or factory packaged heating/ventilating unit that is manufactured within 2 years of the publication date of this standard. This exception applies to the separation of the outdoor air intake and vent discharge of the unit itself and does not exempt maintaining separation distances from one unit to another adjacent unit. [The 2-year time delay is to allow manufacturers an opportunity to redesign and remanufacture equipment in order to meet the separation distances required by this section.]

Separation distances do not apply when exhaust system and outdoor air intake systems do not operate simultaneously.

Note that even where the required minimum separation distances are maintained, reentrainment of odors and toxic gases may still occur depending on wind conditions, building geometry, and exhaust design. An analysis of the air flow pattern around buildings and exhaust plume behavior using the methods described in the AHSRAE handbook, Fundamentals, Chapter 14 can provide more accurate information to assess the potential for reentrainment and to determine adequate separation distances.

[Equation D1 may be summarized as follows:

Class of Air	Dilution Factor D	Square Root of D ( $\sqrt{D}$ )	Separation Distance At Zero Discharge Velocity		Minimum Discharge Velocity For Zero
			Minimum (75 L/s. 150 cfm)	Maximum (1500 L/s. 3000 cfm)	Separation Distance
1	5	2.24	2.5	11.0	894
2	10	3.16	3.5	15.6	1265
3	15	3.87	4.3	19.1	1549
4	25	5.00	5.5	24.6	2000
5	50	7.07	7.8	34.9	2828

**Example 1:** a 2000 L/s (4000 cfm) dome type exhaust fan used for toilet exhaust (class 3 air per Section 5.4.1) is located on a roof near a rooftop unit. For class 3 air the intake must be located per Equation D1. Since the exhaust fan discharge velocity is not directed away from the air intake (discharge is down to roof which then deflects out evenly in all directions), the velocity in Equation D1 is taken as zero. Since the exhaust volume exceeds 1500 L/s (3000 cfm), the value of Q in Equation D1 is taken as 1500 L/s (3000 cfm). The equation (in I-P units) is solved as:

$$S = 0.09 \sqrt{3000} (\sqrt{15-0}/400) \\ = 19 \text{ ft}$$

**Example 2:** Instead of a dome exhaust fan in the previous example, an up-blast exhaust fan is used. The discharge velocity as obtained from manufacturer's data is 6.5 m/s (1300 fpm). The required separation distance is now:

$$S = 0.09 \sqrt{3000} (\sqrt{15-1300}/400) \\ = 3 \text{ ft}$$

**Example 3:** The flue from a forced draft 880 kW (3 million Btu/hr) input natural gas boiler is located near an operable window. The discharge air quantity is approximately 380 L/s (750 cfm) assuming 0.43 L/s per kW of combustion input (250 cfm per million Btu/hr) (per definition of 0 above). The flue is terminated with a flue cap. So no credit for discharge velocity can be taken. However the flue gas is hot and buoyant and thus a 2.5 m/s (500 fpm) upward velocity may be assumed. The minimum separation distance (in SI units) is:

$$S = 0.04 \sqrt{380} (\sqrt{50-2.5}/2) \\ = 4.6 \text{ m}$$

As a Class 5 air stream, distance S becomes a horizontal separation distance (no credit for vertical separation) when the discharge is below the window (see Note 6 to Table D1).

**Example 4:** A rooftop AC unit has an outdoor air intake and economizer relief/exhaust outlet (class 1 air per Appendix A) configured as shown in the section below. The relief air (5000 cfm) is directed away from the intake at 2.5 m/s (500 fpm). (If the exhaust outlet distance above the roof is so small that air will be substantially deflected toward the intake, V should be assumed to be zero in Eq. D1) Since the horizontal separation is zero, the minimum separation distance S is simply the vertical distance D in the figure below. Using the maximum value of 3000 cfm in equation D1, this distance must be:

$$S = 0.09 \sqrt{3000} (\sqrt{5-500}/400) \\ = 4.9 \text{ ft}$$

This separation is required not because Class 1 air is unhealthy, but to ensure the air entering the outdoor air is primarily unventilated outdoor air. This example demonstrates that it is impractical to place the intake and discharge as shown without significant recirculation. Possible solutions: Move the intake to the opposite side of the unit; increase the discharge velocity to more than 4.5 m/s (900 fpm); or add a baffle between the intake and discharge to increase the "stretched string" separation distance.

## APPENDIX E

### RAIN ENTRAINMENT

Outdoor air intakes shall be protected from rain entrainment by use of one of the following:

- a. Louvers or mist-eliminators designed to limit water penetration to 3 mL per m<sup>2</sup> (0.01 oz per ft<sup>2</sup>) of free area when tested in accordance with AMCA Standard 500-1994 (15 minute test period).
- b. Rain hoods sized for no more than 5 m/s (1000 fpm) face velocity and tilted at least 45 degrees downward from the vertical.
- c. Louver or mist-eliminators in conjunction with a drain pan complying with Appendix F.

Exposed Internal insulation shall not be located within 0.5 m (1.5 ft) downstream of the air intake louver, eliminator, or screen.

[Water droplets entrained in HVAC system outdoor air inlets provide niches for microbial growth.]

These rain entrainment requirements may not be adequate to control entrainment of snow. Preheat coils with downstream filters or some other scheme may be needed to avoid snow build-up inside outdoor air intakes or on filters.

## APPENDIX F

### DRAINS AND DRAIN PANS

Drain pans located in supply air ducts, plenums, fan coil units, and other locations shall be sloped and trapped as required to meet the testing requirements in Appendix G. Drains located upstream of fans (those negatively pressurized relative to outdoors or those negatively pressurized to air in a mechanical equipment room) shall have traps having a depth and height differential between inlet and outlet equal to or greater than the fan design static pressure<sub>1</sub> or otherwise sufficient to maintain a water seal and allow complete pan drainage with fans on or off. Traps shall have a means of inspection to verify that the water seal has been maintained [such as an open or screened tee on the downstream end of the trap].<sup>1</sup>

Condensate traps exhibit many failure modes that can impact on indoor air quality. Trap failures due to freeze-up, drying out, breakage, blockage, and/or improper installation can compromise the seal against air ingestion through the condensate drain line. Traps with insufficient height between the inlet and outlet on draw-through systems can cause the drain to back-up when the fan is on, possibly causing drain pan overflow or water droplet carryover into the duct system. The resulting moist surfaces can become sources of biological contamination. Seasonal variations, such as very dry or cold weather may adversely affect trap operation and condensate removal.

**Exception:** Secondary or auxiliary drain pans intended only for emergency overflow collection.

## APPENDIX G

### TESTING OF DRAINS AND DRAIN PANS

Drainage of pans under cooling coils, air washers, humidifiers, outdoor air intake plenums, and other duct or plenum mounted drain pans shall be tested to ensure proper slope and drainage to prevent conditions of water stagnation that result in microbial growth. Drainage shall be tested using the following procedure:

- a. Temporarily plug the drain and cover the entire pan with 13 mm (1/2 in.) water (or to the maximum allowed by the height of the pan)
- b. Start the fan if it is downstream of pan (in the draw through position). [The fan system must be in operation to test for improperly trapped drains that become air locked when the fan creates a negative pressure in the cold plenum.] Stop the fan if it is upstream of the pan (in the blow through position). [Fan operation assists in coil drainage of blow-through system so the pan must be tested with the fan off]
- c. Remove the temporary plug and observe the performance of the system. Drainage is considered acceptable when the pan drains within 3 minutes to leave puddles no more than 50 mm (2 in.) in diameter and no more than 3 mm (1/8 in.) deep.
- d. For draw-through systems, check to see that the water seal is maintained in the trap with the fan operating. Stop the fan and recheck the seal. The trap is considered acceptable if the water seal is maintained in the trap with the fan both OFF and ON. [Traps are not required by this Standard for blow-through systems since supply air leakage out of untrapped drains is not an IAQ issue. Traps can be provided to eliminate this air leakage for energy conservation purposes.]

**Exception:** Secondary or auxiliary drain pans intended only for emergency overflow collection need not be tested.

## APPENDIX H

### MINIMUM AIR CLEANING AND FILTRATION

Mechanical systems that supply air to an occupied space through supply ductwork exceeding 3 m (10 ft) in length or through a humidifier, evaporative cooler, fin-tube heating coil, or cooling coil, shall be provided with particulate filters or air cleaners having a minimum efficiency of 60% when tested in accordance with ASHARE Standard 52.2 for 3  $\mu$ m particles. [This standard is pending approval. If it has not been published before this document, the requirement will reference 25-30% efficient filter as rated by ASHRAE Standard 52.1, Atmospheric Dust Spot Method.] Filters racks shall be designed to minimize the bypass of air around the filter media or filter cartridge frames when the fan is operating. [This section is intended to reduce the accumulation in duct systems and on duct components of dirt which may become a source of microbial growth or which may clog the system and affect airflow. It is not intended to address the possible use of cleaning return air to be used in lieu of outdoor air; which is covered in Section 6.4.]

The 60% filtration for 3  $\mu$ m particles is a minimum filtration requirement but some particulate accumulation within the ventilation system can still be expected over the life of the system. Where the system design can accommodate higher efficiency levels, efficiency levels of >65% for 1-3  $\mu$ m particles will improve indoor air quality with respect to particles and will reduce particulate accumulation in air distribution systems where cleaning is often difficult. Efficiency levels >65% efficiency for particles >0.3  $\mu$ m will be most effective where potentially large concentrations of respirable particles may occur.

## APENDIX I

### INSULATION OF COLD SURFACES

Insulation shall be provided on the following ductwork and piping where located within the building envelope:

- a) Unlined cooling supply ductwork.

Exception:

1. Cooling ducts located within air-conditioned spaces.
2. In other than humid climates, cooling supply ductwork in return air plenums.

[The dewpoint of the return air will generally be less than the surface of the ductwork supplying air to the space. This exception does not apply to humid climates because condensation can occur due to infiltration of humid air into the ceiling plenum and during cool-down transients after moisture has built up in the space when the system was off. Note that insulation of supply ducts in plenums may be required by other codes or may be required to prevent excessive heat gain to supply air]

- b) Chilled water supply and return piping, domestic cold water piping where primary water supply can be expected to be below 13°C (55°F) during the cooling season.
- c) Domestic cold water piping where primary water supply can be expected to be below 13°C (55°F) during the cooling season.

The thickness of insulation shall be as required to prevent condensation on cold surfaces. Insulation that is subject to damage or reduction in thermal resistivity if wetted shall be enclosed with a vapor retarder sealed in accordance with manufacturer's recommendations to maintain the continuity of the barrier. Special coatings that inhibit condensation are an alternative to insulation if approved by the authority having jurisdiction.

[The purpose of this section is to prevent condensation, which may cause material damage or microbial growth in indoor spaces. This section does not consider energy usage, which is covered by ASHRAE 90.1 - 1989.]

## APPENDIX J

### OUTDOOR AIR INTAKE CONTROL

Variable air volume systems (except those supplying 100% outdoor air) shall include controls and devices to measure outdoor airflow at the air handler and designed to maintain outdoor airflow not less than 90% of required levels over the expected supply air operating range. [A major consideration with VAV systems is that the negative pressure behind the outdoor air intake in the mixed air plenum will typically vary with supply air volume and at low supply volumes sufficient outdoor air flow may not be maintained if a fixed outdoor air intake damper position or even if a dedicated fixed minimum air intake is used. In most cases, an active outdoor air control system must be provided to ensure minimum rates are maintained.]

Acceptable air intake measuring devices include those that measure intake volume directly by measuring air velocity through an outdoor air duct or inlet of fixed area (e.g. duct mounted pilot or hot wire anemometer) or differential pressure across a fixed orifice (e.g. wide open damper or other non-adjustable duct mounted obstruction). If the system includes an outdoor air economizer; a separate minimum outdoor air damper may also be required in order to ensure adequate velocity across the intake for an adequate measurement. Note that a fixed speed outdoor air fan without control devices will not maintain rates within the required accuracy unless the fan curve is relatively steep with respect to changes in pressure and/or if the pressure changes in the mixing plenum are relatively small compared to the fan total pressure requirement. Using return air, outdoor air, and mixed air temperatures or CO<sub>2</sub> concentrations to measure air intake percentage is usually inaccurate when the outdoor and indoor values are close together and thus should not be used for this application unless it can be shown to meet the >90% accuracy requirement. Similarly, measuring outdoor air by taking the difference between supply and return air flow measurements will also seldom meet the >90% accuracy requirement due to cumulative errors in air flow measurement and the generally small outdoor air flow rate relative to supply and return air flow rates.



## APPENDIX K

### PRE-OCCUPANCY OPERATION

Ventilation systems shall be operated prior to the time any space served is expected to be occupied for a period of time determined in accordance with the requirement specified below and documented in the ventilation system design documentation (see Design Section 2.18).

Ventilation systems shall include either manual or automatic on/off controls that allow the fan system to operate whenever the spaces served are occupied. When thermostats used to control heating or cooling for systems that also supply required ventilation air include a manual switch accessible to untrained personnel that allows the fan to operate only upon calls for heating or cooling, controls shall be included to ensure the hourly average outdoor air supply rate and overall supply air rate are maintained. [Thermostats often have an "auto" position on the thermostat or subbase fan switch that cycles the fan only when heating or cooling is required. When the fan system also supplies ventilation outdoor air, this causes air supply to be discontinuous. Since many untrained people do not understand this, the switch is often placed in the "auto" position, resulting in inadequate ventilation.]

To comply with this section, the thermostat may be provided without an "auto" position, or with the control sequence in the "auto" position modified in a manner that either operates the fan on a continuous basis when the space is expected to be occupied or that activates a time or other device to ensure that hourly average supply air and outdoor air rates are maintained. Systems operated in this manner must be capable of supply more than minimum rates when the system is on in order to compensate for the time the system is allowed to cycle off.

In general, to comply with this section, programmable timeclock thermostats must be capable of operating the fan on the time schedule rather than simply changing setpoints on a time schedule. Note that many residential thermostats do not have this capability.

## APPENDIX L

### ISOLATION OF MAJOR CONSTRUCTION AREAS

Spaces of an occupied building that are undergoing major construction, renovation, or remedial work that become a temporary but significant source of indoor air contaminants (term "construction areas" hereinafter) shall be isolated from directly adjacent non-construction areas using temporary walls, plastic sheeting, or other vapor retarding barriers. These construction areas shall be maintained at a negative pressure relative to the adjacent non-construction areas by either exhausting construction areas and/or pressurizing adjacent areas. Recirculating return air ducts from construction area shall be temporarily capped and sealed to prevent the spread of contaminants to occupied areas served by the same system. Where particles are the only contaminant of concern, in lieu of capping off return ducts, return air shall be filtered as required to reduce particles with mean diameters less than 10  $\mu\text{m}$  ( $\text{PM}_{10}$ ) to concentrations below those listed in table 5-1. For the purposes of this section, major construction areas within a building undergoing construction activities that require the temporary displacement of occupants for more than 48 hours, or new construction where spaces are newly completed (no former occupants). [This definition is intended to include major tenant work such as complete remodels plus major revisions that include demolishing or finishing drywall partitions, installation of new furnishings and carpeting. Minor touch-up painting and replacement of a small area of carpet are not considered significant contaminant sources.]

These requirements are also applicable to any other construction or installation of materials that generate significant contaminants. Contaminant concentrations within the construction zone itself are covered by applicable construction workplace standards from ACGIH, OSHA, or other local authority. Refer also to IAQ Guidelines for Occupied Buildings under Construction (SMACNA, 1995a).

## **APPENDIX M**

### **PURGING OF MAJOR CONSTRUCTION AREAS**

After construction is complete, major construction areas, as defined in Appendix L, shall be purged by supplying or exhausting no less than the design outdoor air rate required by Section 6 for a period of no less than 48 hours before occupancy. When spaces are exhausted, make-up air may be drawn from adjacent non-construction spaces rather than the outdoors. The requirements of Appendix L, pressurization relationships to adjacent spaces, shall apply until the 48-hour period is complete.

Exception: If it can be demonstrated that an alternative ventilation scheme can provide similar results and if approved by the authority having jurisdiction.

These procedures are also suitable for any other construction or installation of materials that generate significant contaminants. Depending on the new materials in the space and the rate at which they off-gas, a shorter or longer purge period may be required. When ambient conditions and the HVAC system design permit. The effectiveness of the purge, can be enhanced by ventilating spaces at rates far exceeding minimum ventilation rates.

## TAB C-12

# CAMPUS ACCESSIBILITY

### GENERAL OVERVIEW

The University of Arizona is committed to a universally designed built environment that provides equal access to its working, learning and cultural opportunities for all individuals. The intent of Universal Design at The University of Arizona is to enhance the viability of the built environment by creating sustainable facilities and outdoor spaces which are usable through the same means by as many people as possible and minimizes the need for individual accommodation/modification.

Universal Design is the design of the built environment to be usable by all people, to the greatest extent possible, without the need for adaptation or specialized design. Seven general principles guide Universal Design:

- Equitable use
- Flexibility in use
- Simple and intuitive
- Perceptible information
- Tolerance for error
- Low physical effort
- Size and space for approach and use<sup>1</sup>

To assist design professionals in applying Universal Design principles to projects at The University of Arizona, the University has developed specific standards – UA Accessibility Standards. **The UA Accessibility Standards are specific measurements, equipment, and/or arrangements of accessibility compliance that the University feels provide a more universally accessible condition than the minimum requirements outlined in the ANSI standards.**

To make the UA Accessibility Standards easier to apply, the University has created a matrix that is organized into the same groups of accessibility elements as the ANSI standards. The types of design/construction projects have been divided into three groups (New Construction, Renovations, and Historical Renovations) and the applicability of the UA Accessibility Standards has been divided into two categories (Mandatory and Preferred).

### TYPES OF PROJECTS

#### **New Construction**

New construction projects are defined as those projects involving the design and construction of new facilities and outdoor spaces where building and site development are unencumbered by pre-existing building or site accessibility constraints. Additions to existing buildings (inclusive of fully attached or practically free-standing additions) are considered to be New Construction Projects in regards to building accessibility and – if provided with new entrances from the exterior – in regards to site accessibility. Individual evaluation of additions to existing buildings should be undertaken early in the design process to outline the extent of existing building and/or site accessibility compliance that will be necessary.

#### **Renovations**

Renovation projects are defined as those projects involving the alternation of a portion of an existing building. Renovations range from simple aesthetic improvements to complex physical reconfigurations and systems' replacement.

#### **Historic Renovations**

---

<sup>1</sup> Copyright © NC State University, The Center for Universal Design

Projects involving buildings/sites on the National Register of Historic Places must comply with the UA Accessibility Standards in such a way that impact is minimized and a building/site's historic integrity and character defining features are maintained. The determination of a building/site's historical integrity and character defining features shall be made by an individual meeting the Secretary of the Interior's Professional Qualification Standards for Historic Preservation.

Due to the potential range of existing conditions – and the ability of a renovation (or historic renovation) project to address such conditions – it is imperative that each project involving an existing building undergo an evaluation early in the design process to outline the scope of accessibility compliance which can be achieved.

## **CATEGORIES OF APPLICABILITY**

### **Mandatory**

#### ANSI 117.1

All construction projects – new, renovation, and historic renovation – must comply with the ANSI 117.1 accessibility requirements.

#### UA Accessibility Standards

New Construction projects must comply with mandatory standards throughout both the building and site. Additions to existing buildings must comply with mandatory standards throughout the building and – if provided with new building entrances from the exterior – the site. Renovation projects must comply with mandatory standards within the physical boundaries of the renovation.

### **Preferred**

In regards to achieving accessibility as part of renovations, the University recognizes that there are some challenges renovation projects cannot be overcome, such as:

- Conditions physically beyond the limits of the renovation,
- Spatial/structural/technical conditions which make accessibility infeasible to achieve, and/or
- Conditions which cannot be addressed within a defined project scope or budget.

Many of the UA Accessibility Standards become preferences – rather than mandatory – when there are significant constraints to achieving accessibility. However, the University expects design professionals to bring an innovative and resourceful approach to renovation projects on campus, and strive to achieve compliance with the UA Accessibility Standards.

## **CODES & STANDARDS**

Americans with Disabilities Act of 1990 (ADA), 42 United States Code, §12101 et seq., as amended.

ICC/ANSI American National Standard 117.1-1998 – Accessible and Usable Buildings and Facilities

Arizonans with Disabilities Act of 1992, *Arizona Revised Statutes* § 9–499.02; 41–1492 et seq.

**SECTION 1 - BUILDING BLOCKS**

**Reach Ranges**

**N R H**

M	M	M	Except as outlined in this section, the <i>operable portion</i> of building equipment and controls (such as electrical switches, fire alarm pull stations, above-work-surface telephone and data outlets, thermostats, elevator call buttons, etc.) shall be located no higher than 44" above the finished floor. Information on reach ranges for equipment in rest rooms, toilet rooms, and bathing rooms, see SECTION 4 - PLUMBING ELEMENTS AND FACILITIES.
---	---	---	---

M	M	M	Door access card swipes and keypads shall be centered at 38" above finished floor.
---	---	---	--

M	M	M	Control plates for automatic door openers shall be centered at 33" above the finish floor. For horizontal locations, see SECTION 2 - Accessible Routes, Doors and Doorways.
---	---	---	---

**SECTION 2 – ACCESSIBLE ROUTES**

**During Construction**

**N R H**

M	M	M	Renovations that temporarily eliminate building-wide accessibility accommodations (i.e. change of building entrance, access through building, accessible restrooms, elevators, etc.) shall provide comparable, temporary replacements - including temporary directional signage - for said accommodations.
---	---	---	--

M	M	M	Construction fencing/staging, earthwork, temporary drainage conditions shall be designed to maintain existing accessible routes or alternative, temporary accessible routes – including temporary directional signage - shall be provided.
---	---	---	--

M	M	P	Temporary ramps used during construction shall have ADA compliant handrails, landings, toe kicks, and shall attempt to achieve a maximum slope of 1:16.
---	---	---	---

**Surface Materials**

**N R H**

M	M	M	Decorative ground surface treatments (i.e. exposed aggregate concrete, unit pavers, stone paving, etc.) shall provide a surface free of horizontal gaps or vertical transitions in excess ½" inch.
---	---	---	--

M	M	M	Granular surface materials used to create exterior paths of travel shall provide a stable surface that is usable during all weather conditions.
---	---	---	---

Project Type Key  
 N = New Construction  
 R = Renovation  
 H = Historic Renovation

Applicability Key  
 M = Mandatory  
 P = Preferred

### Surface Materials (continued)

**N R H**

M	M	M	Changes in surface material - both inside and outside - shall be provided with a durable transition/threshold that will meet the change in elevation height requirement throughout the life of the building/space.
---	---	---	--

M	M	M	Granular surface materials may not be used on path of travel surfaces with a slope steeper than 1:20.
---	---	---	---

M	M	M	The University's standard for detectable warning surface is TekWay Dome-Tiles manufactured by StrongGo LLC (Phone 520-547-3510, Fax 520-547-3515, Web stronggo.com) or equal. The standard color to be used is Terracotta. Any of the available tile sizes are acceptable.
---	---	---	--

M	M	M	The depth of detectable warning surface in the direction of travel shall not exceed 24".
---	---	---	--

### Building Entrances

**N R H**

M	P	P	The main entrance of a building shall be universally accessible via a single route.
---	---	---	---

M	P	P	All building entrances shall be accessible – including “employee” entrances, or entrances other than the “main” entrance.
---	---	---	---

### Doors and Doorways

**N R H**

M	M	M	Kick-plates shall be provided on non-latching/push-pull hardware-type doors.
---	---	---	--

M	M	M	<p>Frameless Glass Doors – These types of doors shall be detailed to provide for the following accommodations:</p> <ul style="list-style-type: none"> <li>• Contrast at latch-side edge of the door,</li> <li>• Where door uses a floor pivot, the required clear width shall be provided when door is in any position (i.e. a wider door may be required or the installation of a door stop to prevent the door opening past 90 degrees),</li> <li>• An automatic door operator. For banks of frameless glass doors, only one automatic door operator will be required.</li> </ul>
---	---	---	---

M	M	M	All latching door hardware must be lever handle type.
---	---	---	---

M	M	M	Revolving doors shall not be used.
---	---	---	------------------------------------

Project Type Key  
N = New Construction  
R = Renovation  
H = Historic Renovation

Applicability Key  
M = Mandatory  
P = Preferred

### Automatic Door Operators

**N R H**

M	M	M	Automatic door openers shall be installed at each main entrance to a building.
M	M	M	Electrical infrastructure for automatic door operators shall be provided at all accessible building entries.
M	M	M	For guidance on horizontal placement of control plates for Automatic Door Operators refer to diagrams C12-D1 thru C12-D6. For vertical placement of control plate for Automatic Door Operators refer to Section 1 – Building Blocks, Reach Ranges.

### Ramps

**N R H**

M	M	P	Where changes in elevation are encountered (including courtyards and open spaces) full consideration shall be given to a universally accessible design that addresses the elevation change.
P	P	P	Where grades / space allow, sloped sidewalks (slope 1:20 or flatter) shall be used in lieu of ramps to overcome changes in elevation.
M	P	P	Ramps (defined as anything steeper than a 1:20 slope) shall have a maximum 1:16 slope.

### Curb Ramps

**N R H**

M	M	M	Curb ramp slopes shall be 1:12.
M	M	M	Concrete aprons shall be provided at the bottom of curb ramps.
M	M	M	Curb ramps within sidewalks (parallel to the path of travel) shall be provided with a 1:16 slope.
M	M	M	The University's standard for detectable warning surface is TekWay Dome-Tiles manufactured by StrongGo LLC (Phone 520-547-3510, Fax 520-547-3515, Web stronggo.com) <b>or equal</b> . The standard color to be used is Terracotta. Any of the available tile sizes are acceptable.
M	M	M	The depth of detectable warning surface in the direction of travel shall not exceed 24".

### Elevators and Lifts

**N R H**

M	M	M	Platform lifts shall not be used.
---	---	---	-----------------------------------

Project Type Key  
N = New Construction  
R = Renovation  
H = Historic Renovation

Applicability Key  
M = Mandatory  
P = Preferred



### SECTION 3 – GENERAL SITE AND BUILDING ELEMENTS

#### Parking Spaces

**N R H**

M	M	M	Universal parking space shall be 132" wide with a 60" access aisle.
M	M	M	Accessible loading zone spaces shall be provided by locating loading space(s) adjacent to universal parking spaces, thus sharing the access aisle.

### SECTION 4 - PLUMBING ELEMENTS AND FACILITIES

#### General

**N R H**

M	M	M	No "vestibule" (i.e. doors in series) entries into rest rooms.
M	P	P	Gender neutral rest rooms shall be accessible for the purposes of privacy and/or assisted use.
M	P	P	Accessible gender neutral rest room(s) shall not be used as a substitute for providing accessibility to multi-stall rest rooms.
M	M	M	A full length mirror (in lieu of a downward angled mirror) shall be provided in rest rooms.

#### Toilet and Bathing Rooms

**N R H**

M	P	P	Single occupant public/employee restrooms shall be fully accessible.
M	P	P	Private toilet rooms for employees shall be accessible for approach, entry, and exit, and provided with 5' turning radius.

#### Water Closets and Toilet Compartments

**N R H**

M	P	P	A side approach toilet with a 5' turning radius located completely within the compartment shall be provided.
M	M	M	Toilet Paper Dispensers shall be located: <ul style="list-style-type: none"> <li>• With the front edge of the dispenser no further than 32" from the rear wall of the compartment,</li> <li>• Centered 26" above the finished floor,</li> <li>• Below the side grab bar.</li> </ul>

Project Type Key  
N = New Construction  
R = Renovation  
H = Historic Renovation

Applicability Key  
M = Mandatory  
P = Preferred

### Water Closets and Toilet Compartments (continued)

**N R H**

M	M	M	Toilet Paper Dispensers in accessible toilet compartments shall be continuous-feed type dispensers; no separate sheet, controlled feed, or large roll dispensers shall be used.
M	M	M	Flush valves for toilets shall be located the wide approach side of the toilet.
M	M	M	A coat hook at 44" above the floor must be provided in the accessible toilet compartment.
M	M	M	Door pulls shall be provided on both sides of doors to accessible toilet compartments. For doors that open out from the compartment, a second inside door pull – in addition to the door pull provided at the latch - shall be installed at 36" above finished floor and 8" from the hinge side of the door.
M	M	M	Latching mechanism for accessible toilet compartment doors shall be operable with a closed fist.

### Lavatories and Sinks

**N R H**

M	M	M	The operable portion of soap dispensers, paper towel dispensers, electric hand dryers, etc. shall be no more than 44" above the finished floor.
M	M	M	Soap dispensers shall be operable with one hand, located within an appropriate reach range, and provided with clear floor space.
M	M	M	A 29" knee clearance shall be provided under accessible sinks. "Extended" sinks (those with a deep front-to-back dimension) shall not be used to achieve the 29" knee clearance.
M	M	M	Sink faucets shall be automatic, wrist blade, lever-operated, or "push-on" type with delayed shut off to permit single hand operation.
M	M	M	Adaptable sinks with accessible cabinetry (such as sinks found in employee kitchen areas, laboratories, dwelling units, etc.) shall be provided with a finished flooring surface in the under-cabinet space. The cabinet door shall be provided with an integral toe kick.

Project Type Key  
 N = New Construction  
 R = Renovation  
 H = Historic Renovation

Applicability Key  
 M = Mandatory  
 P = Preferred

### Shower Compartments

**N R H**

M	M	M	<p>In non-residential conditions, accessible showers shall be:</p> <ul style="list-style-type: none"> <li>• Specifically a 36"x36" dimension</li> <li>• A transfer-type entry</li> <li>• Provided with a padded, fold down bench with integral support legs that extends the full width of the stall and located on the wall opposite the controls/shower head.</li> </ul> <p>See Section 8 - Dwelling Units for requirements on shower compartments in residential conditions</p>
---	---	---	--

## SECTION 5 – COMMUNICATION ELEMENTS AND FEATURES

### Assisted Listening Systems

**N R H**

M	M	M	<p>For ANSI or ADAAG required assisted listening system installations, consult with the Disability Resource Center on the appropriate type of system for the building/space.</p>
---	---	---	--

### Emergency "Blue Light" Phones

**N R H**

M	M	M	<p>Access shall be provided to Emergency "Blue Light" Phones. Specifically, the following shall be provided (see also Diagram C12-D7):</p> <ul style="list-style-type: none"> <li>• An accessible approach,</li> <li>• Accessible clear ground space in front of the operable portion of the phone.</li> </ul>
---	---	---	--

M	M	M	<p>Pedestal mounted Emergency "Blue Light" phones shall be installed such that the center of the speaker is no higher than 48" above the surface of the clear ground space (see also Diagram C12-D8).</p>
---	---	---	---

## SECTION 6 – SPECIAL ROOMS AND SPACES

### Auditorium, Tiered Classrooms, and Assembly Areas

**N R H**

M	P	P	<p>In auditoriums, tiered classrooms, and assembly areas wheelchair accessible seating and companion seats shall be provided in a variety of locations throughout the seating area.</p>
---	---	---	---

M	P	P	<p>Wheelchair access shall be incorporated in the primary access route to the stage / teaching station areas.</p>
---	---	---	---

Project Type Key  
N = New Construction  
R = Renovation  
H = Historic Renovation

Applicability Key  
M = Mandatory  
P = Preferred

**N R H Auditorium, Tiered Classrooms, and Assembly Areas – continued**

M	P	P	In fixed seating situations, seats with fold up arms – marked for use by disabled – shall be provided.
---	---	---	--

**Academic Laboratories**

**N R H**

M	M	M	Academic (teaching) laboratories shall be accessible. The accessible work station(s) shall provide, or have the capacity to provide, those elements of laboratory furnishings and equipment specific to the type of teaching expected to be conducted in the laboratory in question.
---	---	---	--

M	M	M	Provide at least one wheelchair accessible work station in each lab. The workstation shall include: <ul style="list-style-type: none"> <li>• A bench space 7' long, either adjustable in height or a maximum of 32" high with 29" minimum clearance below</li> <li>• A sink with faucet controls located on the side with single action lever controls or wrist blade handles</li> <li>• Lab gases and power outlets located on the side of the bench or within 18" of the front edge of the bench with single action lever controls or wrist blade handles</li> <li>• Storage facilities (for lab equipment/materials to be utilized by students in the lab) within ADA reach ranges</li> </ul>
---	---	---	--

M	M	M	Where academic laboratories utilize fume hoods, provide at least one accessible fume hood with: <ul style="list-style-type: none"> <li>• A maximum of 32" high work surface with 29" clearance below</li> <li>• Gas/services within the hood located on the side of the hood or within 18" of the front edge of the hood, with single action lever controls or wrist blade handles</li> </ul>
---	---	---	---

M	M	M	Eyewashes / safety showers shall be independently accessible and operable by a wheelchair user.
---	---	---	---

M	P	P	Aisles 42"-48" wide are required for accessible benches and fume hoods.
---	---	---	---

M	M	M	Where non-laboratory teaching amenities (writing surfaces, lecture areas, etc.) are provided within academic laboratories, at least one accessible workstation which includes such amenities shall also provided.
---	---	---	---

M	M	M	Specific purpose teaching facilities (balance or tissue culture rooms, etc.) shall provide a wheelchair accessible space with: <ul style="list-style-type: none"> <li>• A 5' diameter turning radius within the room</li> <li>• A bench space 2'-6" long with a maximum 32" height and a minimum 29" clear space below.</li> </ul>
---	---	---	--

Project Type Key  
N = New Construction  
R = Renovation  
H = Historic Renovation

Applicability Key  
M = Mandatory  
P = Preferred

## Research Laboratories

N R H

M	P	P	Research laboratories shall have provisions for wheelchair accessibility. The accessible work station(s) shall provide, or have the capacity to provide, those elements of laboratory furnishings and equipment specific to the type of teaching expected to be conducted in the laboratory in question.
---	---	---	--

M	P	P	Individual research laboratory rooms assigned to specific employees are considered employee work areas. For employee work areas, basic access is required for approach, entry, and exit.
---	---	---	--

M	M	P	<p>Research laboratory rooms with open assignment workstations/bench space shall be provided with at least one accessible workstation with:</p> <ul style="list-style-type: none"> <li>• A bench space 7' long, either adjustable in height or a maximum of 32" high with 29" minimum clearance below</li> <li>• A sink with faucet controls located on the side (not rear) with single action lever controls or wrist blade handles</li> <li>• Lab gases and power outlets located on the side of the bench or within 18" of the front edge of the bench with single action lever controls or wrist blade handles</li> <li>• Aisles 42"-48" wide for accessible bench space/hoods</li> <li>• Storage facilities within ADA reach ranges</li> </ul>
---	---	---	---

M	M	P	<p>Shared, specific purpose research laboratory rooms (balance or tissue culture rooms, etc) in open assignment research laboratories shall be provided with at least one wheelchair accessible workstation/hood with:</p> <ul style="list-style-type: none"> <li>• A 5' diameter turning radius within the room</li> <li>• A bench space 2'-6" long with a maximum 32" height and a minimum 29" clear space below.</li> </ul>
---	---	---	--

M	M	P	<p>Shared fume hoods in open assignment research laboratories shall provide at least one accessible fume hood with:</p> <ul style="list-style-type: none"> <li>• A maximum of 32" high work surface with 29" clearance below</li> <li>• Gas/services within the hood located on the side of the hood or within 18" of the front edge of the hood, with single action lever controls or wrist blade handles</li> </ul>
---	---	---	---

## SECTION 7 – BUILT-IN FURNISHINGS AND EQUIPMENT

### General

N R H

M	M	M	When unfixed furniture may be moved into the path of travel, 42" - 48" aisles for clearance / maneuvering shall be provided.
---	---	---	--

Project Type Key  
N = New Construction  
R = Renovation  
H = Historic Renovation

Applicability Key  
M = Mandatory  
P = Preferred

### Seating at Tables, Counters, and Work Surfaces

**N R H**

M	M	M	The top of built-in work surfaces which are used for extended periods of time (computer tables, study carrels, etc.) by transient populations shall be a maximum of 32" above finished floor.
---	---	---	---

M	M	M	The minimum clearance below built-in furniture shall be 29" above finished floor.
---	---	---	---

M	M	M	Accessible height service / reception counters – 34" above finished floor – shall be located at the primary queuing point or staffing location.
---	---	---	---

## SECTION 8 – DWELLING UNITS

### General

**N R H**

M	P	P	Residence Halls shall incorporate adaptable design features to allow persons with disabilities a wide range of housing options throughout the Residence Hall system.
---	---	---	--

M	P	P	Residence Halls shall provide all residents and visitors access to all publically accessible areas of the facility.
---	---	---	---

### Entrances

**N R H**

M	P	P	All accessible building entries to residence halls shall be provided with the infrastructure to permit unlocking the door(s) with a proximity card.
---	---	---	---

M	P	P	Secondary accessible building entries to residence halls shall be provided with automatic door operators.
---	---	---	---

### Paths of Travel

**N R H**

M	P	P	Stairs and elevators shall be located on a common route within the building
---	---	---	---

M	M	M	Interior doors along the path of travel to accessible rooms and those to building wide amenities/services (i.e. kitchen, laundry, study/common rooms, etc.) shall be provided with automatic door operators.
---	---	---	--

Project Type Key  
N = New Construction  
R = Renovation  
H = Historic Renovation

Applicability Key  
M = Mandatory  
P = Preferred

### Paths of Travel - continued

**N R H**

M	M	M	The location of accessible rooms within residence halls shall be: <ul style="list-style-type: none"> <li>• On a convenient path of travel from the main entrance and elevator</li> <li>• Close to building-wide amenities/services (i.e. kitchen, laundry, study/common rooms, etc.)</li> </ul>
---	---	---	---

### Doors

**N R H**

M	P	P	Accessible rooms on all floors of a residence hall shall be provided with the infrastructure for automatic door operators.
---	---	---	--

M	P	P	If “peep holes” are provided to resident rooms, provide an additional “peep hole” at 48” above finished floor in the doors of accessible rooms
---	---	---	--

M	M	M	Infrastructure for door knock signalers (i.e. strobes) shall be provided for the entry doors to accessible rooms and the doors to bathrooms attached to accessible rooms.
---	---	---	---

### Bathrooms

**N R H**

M	M	M	Shower compartments in residential condition accessible bathrooms shall be: <ul style="list-style-type: none"> <li>• Roll-in showers</li> <li>• Specifically a 30”x60” dimension</li> <li>• Provided with a padded, fold down bench with integral support legs installed on the wall adjacent to the controls/shower head.</li> </ul>
---	---	---	---

M	M	M	Accessible lavatories in residential condition accessible bathrooms shall be provided with counter top space (to accommodate personal care items)
---	---	---	---

Project Type Key  
 N = New Construction  
 R = Renovation  
 H = Historic Renovation

Applicability Key  
 M = Mandatory  
 P = Preferred

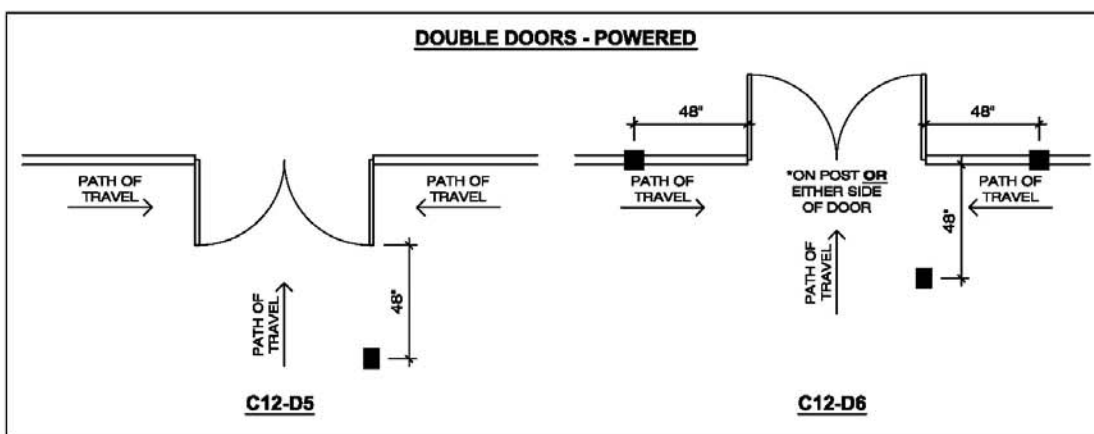
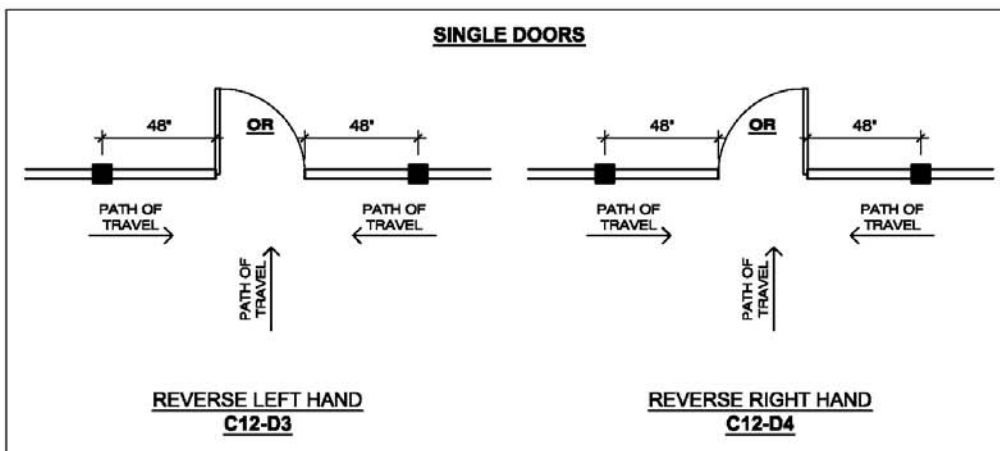
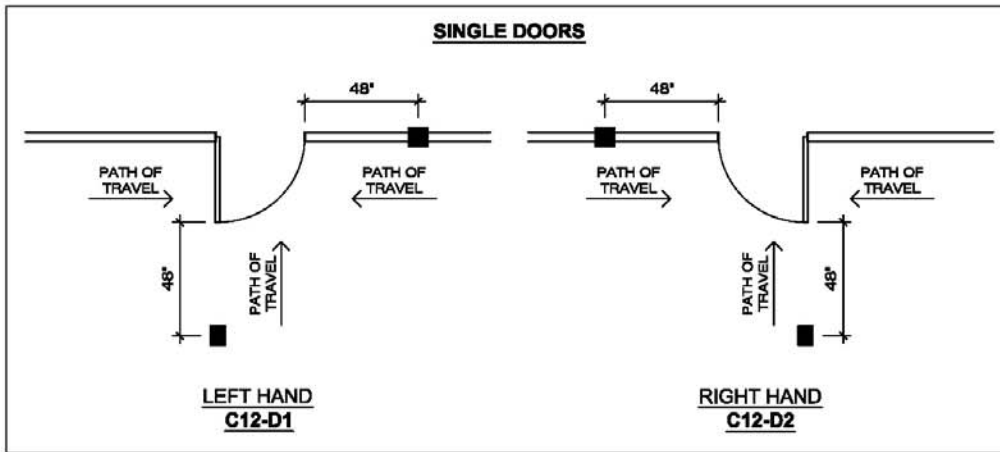



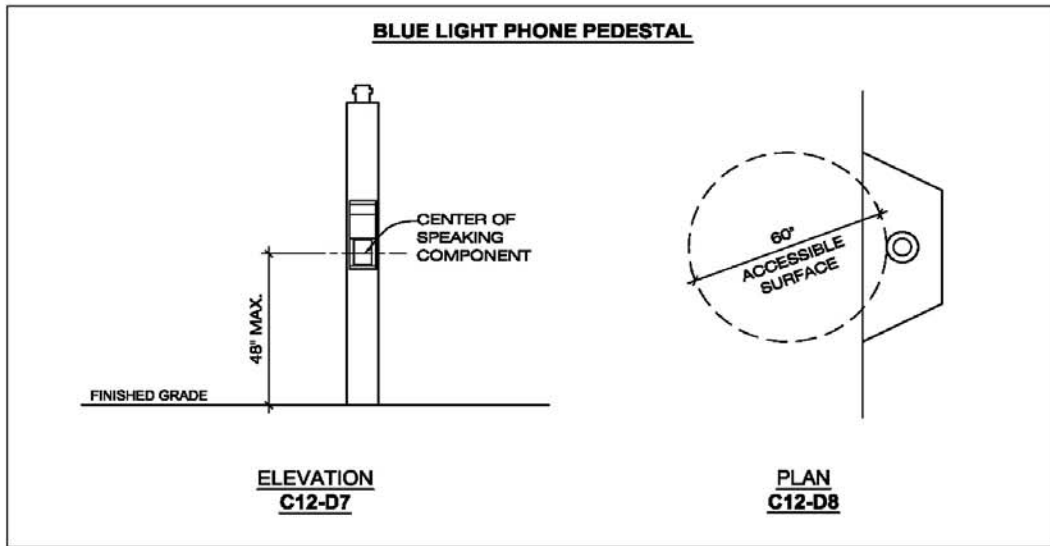

## TAB C-13

### CAMPUS SUSTAINABILITY

As stated in the presidential memorandum on Campus Sustainability at the University of Arizona dated 9/28/07, the University is committed to a leadership role in promoting sustainability on our campus and in our design and construction practices. The University has established a goal, wherever appropriate, to acquire LEED Silver Certification as established by the United States Green Building Council. Therefore the following criteria should be followed:

- **WHERE REQUIRED**

- **New Buildings** - A minimum of LEED Silver Certification for all new construction, where appropriate.
- **Building Expansions** - Major building expansions should anticipate LEED Silver Certification for the expansion, if possible, and if the project scope and budget support it, for the entire building. This goal will be established at project initiation.
- **Renovations** - Renovation projects are defined as those projects involving the alteration of a portion of an existing building. Renovations range from simple aesthetic improvements to complex physical reconfigurations and systems' replacement. Due to the potential range of existing conditions – and the ability of a renovation project to address such conditions – it is incumbent that each renovation project undergoes an evaluation early in the budgeting and/or design process to determine if LEED certification can be achieved.

In general, for minor renovations or room specific renovations, requirements for LEED Certification will not be part of the project scope. For projects where major renovation is part of the scope, inclusion of LEED Silver Certification should be anticipated. For example, in major renovation projects that affect entire floors or buildings, LEED Silver Certification should be anticipated if reasonably feasible.

- **DESIGN CRITERIA**

- In general, sustainable design precepts appropriate for the Sonoran Desert environment should be incorporated – water conservation, building orientation, sun exposure and shade are issues of special concern in desert environments.
- Appropriate passive solar design techniques should be incorporated and where the project scope and budget support it, solar water heating and photovoltaic systems should be considered if determined to be economically viable
- Desert appropriate landscape design, water harvesting techniques and use of the University's reclaimed water system where available should be incorporated.
- Appropriate day lighting design should be considered to minimize the requirements for artificial lighting and to promote the interior/exterior connection of the building.
- Appropriate use of construction materials, mechanical, electrical, and plumbing systems should be selected that not only result in a building with an intended useful life of 50 to 100 years but respond to the attributes of the Sonoran Desert environment.

## TAB C-14

### GENDER NEUTRAL RESTROOM REQUIREMENTS

As stated in the presidential policy statement on restroom access at the University of Arizona dated 6/26/06, the University is committed to designating and maintaining a minimum of one gender neutral restroom in as many of its buildings as reasonably feasible. Therefore the following criteria should be followed:

- **WHERE REQUIRED**

- **New Buildings** - A minimum of one gender neutral (GN) restroom should be provided in each new building.
- **Building Expansions** - Major building expansions should include a GN restroom unless it is determined that the existing facility has a restroom that can be designated or converted *as part of the project scope*.
- **Renovations** - Renovation projects are defined as those projects involving the alternation of a portion of an existing building. Renovations range from simple aesthetic improvements to complex physical reconfigurations and systems' replacement. Due to the potential range of existing conditions – and the ability of a renovation project to address such conditions – it is incumbent that each renovation project undergoes an evaluation early in the design process to outline the scope of compliance which can be achieved.

In general, for minor renovations or room specific renovations, requirements for GN restrooms will not be part of the project scope. For projects where major bathroom renovations are part of the scope, inclusion of one GN restroom, if not already extant, should be included. For major renovation projects affecting entire floors or buildings GN restrooms should be provided if reasonably feasible.

Where existing facilities are renovated, converted or re-designated, the gender neutral restroom may contain multiple stalls.

- **Residential Facilities** - Because of the variety of facilities that Residence Life deals with, the Consultant shall discuss with the User specific project requirements and criteria.

- **DESIGN CRITERIA**

- In new construction, each GN restroom shall meet handicap accessibility criteria. Accessible GN restroom(s) shall not be used as a substitute for providing accessibility to multi-stall rest rooms.
- In new construction, each GN restroom shall include one diaper changing table in addition to standard restroom fixtures/equipment.
- Refer to other sections of this DSS as applicable for plumbing and bathroom accessory criteria.
- The plumbing fixtures in GN restrooms shall count towards the total fixture counts required by code.
- All GN restrooms will be designated as RESTROOM with the universal male symbol, universal female symbol and universal handicap accessible symbol (if applicable).

## DIVISION 2 - SITEWORK

### Section 02100 - Demolition

#### Introduction

This section shall be used by the consultant to accurately define the scope of the demolition effort required for the project. Whenever possible a demolition plan shall be created to graphically show the extent of the demolition work.

The scope of the demolition plan should be carefully reviewed and coordinated with Risk Management to ascertain the existence of any hazardous materials requiring special attention. Most laboratory equipment will require decontamination before demolition and/or removal, i.e., fume hoods, laminar flow enclosures, clean benches, biological safety cabinets, etc.

Provisions shall be made in the documents to require that all demolition work be performed without disruption to adjacent occupied areas, i.e., off hours work. Only when the anticipated demolition work will not present a disruption to the user or occupant can the assumption be made that it can be conducted at any time.

Demolition work is usually associated with trash and dust. Appropriate provisions shall therefore be made to address mitigation procedures in the demolition work.

The demolition plan shall identify all materials/equipment, etc., which are to be reused and/or salvaged by either the University or the Contractor. Please keep in mind that all equipment and building material is ultimately the property of the University of Arizona and only when its salvage cost exceeds its usable value is it to be considered unwanted. This determination can only be made by the University of Arizona.

A complete investigation of the area(s) shall be performed so that all existing aspects and elements affected by the project are either removed under the demolition plan or incorporated into the new work with the installation drawings, i.e., existing/abandoned outlets, t-stats etc.

#### Part 1 - General

- Other than items which are to be reused there are basically two groups of salvageable material presented with nearly all projects. Care must be exercised when handling all salvageable material so as to maintain its value.
- Items which are **always** salvaged by the University.
  - LED exit lights
  - Chalk/White boards
  - EMCS equipment
  - Meters (all kinds)
  - Door hardware
  - Drinking fountains
  - Window blinds
  - Backflow preventers
  - Fire alarm devices
  - Simplex equipment
  - Lab fixtures
- Items which the University **may elect** to salvage. Depending on the item the University will determine on a case by case basis whether salvage is warranted. The following is a representative, but not conclusive, list of items in which salvage may be considered.
  - Wood/HM doors
  - Electrical panels
  - Mechanical equipment
  - Ceiling diffusers
  - Projection screens
  - Mirrors
  - Irrigation equipment
  - Plumbing fixtures
  - Casework
  - Disconnect switches
  - Elevator equipment
  - Soap/Paper dispensers
  - Clocks
  - Access doors
  - Electrical light fixtures
  - Electrical equipment
  - Starters
  - Windows
  - Transformers
  - Thermostats
  - Shelving

- Refrigeration equipment                      Landscape plantings                      HVAC mixing boxes
- *Lab equipment (hoods)*

- Prior to finalizing the construction documents the Architect shall conduct a site meeting with the appropriate Facilities Management personnel and determine precisely what items are to be salvaged. The documents should then clearly identify what is to be salvaged, by whom and where it is to be delivered to or stored. Options include but are not limited to:
  - Removal and transport by contractor.
  - Removal by contractor and transport by UA.
  - Removal and transport by UA.
  - Transportation destinations include the Facilities Management compound, 22nd St. warehouse (Material Management surplus property sales), Sunnyside storage yard or any other location determined during the site meeting.
- Items which are to be surplus and delivered to the 22nd St. warehouse must be accompanied with a completed Request for Property Disposal Form from the Office of Material Management.
- Whenever the UA is to participate in either the removal or transportation of salvage materials a time frame and contact person shall be identified and referenced in the documents.
- All items encountered which contain an affixed University of Arizona Inventory Control tag ( "A" tag) require special procedures for dispersal. Consequently these items should be brought to the attention of the UA Project Manager. Items which contain an "A" tag are part of the registered inventory of a particular UA department or unit and dispersal must be coordinated through their respective business manager.
- Fluorescent light fixture tubes and certain light fixture ballasts must be separately disposed of in accordance with applicable environmental regulations. Consequently, the removal and disposal of existing fluorescent light fixtures shall include the following:
  - All fluorescent tubes shall be removed and packaged by the Contractor in cartons supplied by the Facilities Management Electric Shop. The number of tubes in each carton shall be clearly marked on the outside of the carton. Contractor to deliver packaged tubes to the Facilities Management Electric Shop for disposal.
  - Fixture ballasts not clearly marked as containing "No PCB's" shall be removed by the Contractor and after short clipping all wires place them in a metal drum supplied to the jobsite by University of Arizona Risk Management. After completion of the demolition effort University of Arizona Risk Management will remove the drum for disposal offsite. Apportioned disposal costs are then to be charged to the project.

- **Part 2 - Products**

- No discussion.

**Part 3 - Execution**

- All electrical services discontinued with the demolition effort shall be properly "tagged out".
- Because all facilities within the University of Arizona campus are classified as NESHAP facilities, the regulatory requirements of the Pima County Department of Environmental Quality apply to all demolition projects. Consult with Risk Management to determine the exact requirements. All permits and fees for demolition are the responsibility of the contractor but these requirements should be specifically identified in the contract documents.

**End of Section 02100**

## **DIVISION 2 - SITEWORK**

### **Section 02200- Earthwork**

#### **Introduction**

Inclusion of the Soil Report in the specifications is not permitted on University projects. The Consultant shall make the Report available at his office for Contractor's inspection if they so desire. It is the responsibility of the structural engineer to interpret the report and include specifications for soil preparation in accordance with his structural design. The Consultant should be aware that earthwork may involve not only preparation of soils for building and structures but for parking lots, slabs on grade (sidewalks) and landscaped areas. Appropriate references to other specification sections should be included.

Determine if construction activity resulting from the project will disturb *1 acre* or more. If *1 acre* or more is disturbed a Storm Water Pollution Prevention Plan (SWPPP) will be required and a EPA NPDES Storm Water Construction General Permit must be secured. UA, Risk Management may be contacted for guidance in securing this permit and filing the associated EPA Notice of Intent (NOI).

#### **Part 1 - General**

- Surplus material shall become the property of the Contractor and removed from the site.
- Rubble, trash and other demolished materials shall be taken to the appropriate dump sites and disposed of legally.
- Soil testing of compacted fill and/or inspection of caissons will be accomplished and paid for by the University.

#### **Part 2 - Products**

- There are no unique University requirements.

#### **Part 3 - Execution**

- Comply with City or Tucson and Pima County dust control standards.

**End of Section 02200**

## **DIVISION 2 - SITEWORK**

### **Section 02280 - Soil Treatment**

#### **Introduction**

The work in this section includes treatment of soils under buildings for termites and under paved areas for control of vegetation.

#### **Part 1 - General**

- Provide certification as to chemical type, rate of application and a written warranty.
- Warranty for termites and weed growth on new work shall be for 5 years. In alteration/addition work where termite five year warranty is not available, contractor shall certify application rate.

#### **Part 2 - Products**

- Chemicals shall be EPA certified and approved.
- Chemical for weed control shall be "Surflan" pre-emergent.

#### **Part 3 - Execution**

- Termite treatment is required on new and alteration/addition projects under all footings, along foundation walls and under interior slabs on grade and exterior porch slabs.
- Treatment for weed control shall be applied to soil below paved areas, both asphaltic concrete and concrete flatwork, on open soil area and areas covered with decomposed granite. Application of chemicals shall not be harmful to the roots of adjacent plants.

**End of Section 02280**

## **DIVISION 2 - SITEWORK**

### **Section 02500 - Paving and Surfacing**

#### **Introduction**

A specification section shall be provided for work under this section including Special Provisions and other qualifications as necessary to make the specifications project specific.

Consultants shall tailor their specifications to local practice and University requirements. Testing of materials will be by agencies hired by either the Contractor or the University.

Require repaving and stripping if staging or yard areas for construction are in an existing parking lot or an adjacent street.

The most current version of the Arizona Bicycle Planning and Design Guidelines shall be used for design and specification of paving and signage for bicycle routes and facilities.

Concrete surfaces shall be provided at motorcycle parking and in maintenance areas where oil or gas spillage could occur.

Minimum standard parking space size on the U of A campus is 8'-4" wide x 18'-0" long. Minimum lane width is 20'. The universal 11'-0" wide handicapped space is standard with 5' unload zone, white or blue handicap sign on pavement and HC sign on post complying with ADA requirements.

Handicapped ramps shall be provided when the project is located at an intersection and at other intervals along a street if crosswalks are provided. Inclusion of these ramps should be evaluated with the Project Coordinator.

#### **Part 1 - General**

- Damage to existing utilities shall be repaired and made good by the contractor.
- Cold patching may be used only as a temporary measure. Permanent patches must be hot mix.
- The most current versions of the Standard Specifications for Public Improvements and the Standard Details for Public Improvements by Pima County and the City of Tucson shall be used and referenced for this work.

#### **Part 2 - Products**

- There are no unique University requirements in this Section. Generally design mixes should conform to City of Tucson standard mixes.

#### **Part 3 - Execution**

- The most current versions of the Standard Specifications for Public Improvements and the Standard Details for Public Improvements by Pima County and the City of Tucson shall be used or referenced for this work.
- If asphalt patch is less than 25 sq. ft., hand method of placement and screeding can be used. Materials must be hot mix.
- If asphalt patch is greater than 25 sq. ft. or a critical area, use lay down machine.
- When working at curbs, widen excavation, form and pour curb, cut straight asphalt edge, and patch.
- All asphalt cuts shall be saw cut.



- Manholes and valves shall be adjusted to grade after paving. Final adjustment shall be provided with concrete paving patch to roadway grade.

**End of Section 02500**

**DIVISION 2 – SITEWORK**

**Section 02610 - Site Chilled Water and Heating Water Utilities**

**Introduction**

Piping of site utilities

CHILLED WATER, HEATING WATER

**Part 1 - General**

- Refer to Section 15050 common piping materials and methods.
- Refer to Section 15250 for insulation requirements.
- Refer to Section 15980 for meter requirements.

**Part 2 - Products**

- Pipe Schedule:

<u>Service</u>	<u>Size</u>	<u>Pipe</u>	<u>Fittings</u>	<u>Joints</u>
Chilled Water	4" and larger	Ductile iron, lined	Ductile iron, lined	Bell & spigot or mechanical joint
	16" and over	May Use Concrete cylinder	Concrete cylinder	bell & spigot
	Below 4"	Type K copper seamless Hard drawn	wrought copper	15% silver solder
Heating Water Pre-insulated Pipe System	All sizes	Copper - Type "K" Seamless Hard Drawn	Wrought Copper	15% Silver Brazed
		<u>Or</u>	<u>Or</u>	<u>Or</u>
		Schedule 40 Steel	Forged carbon steel	Bevel welded

- Pipe & fittings
  - Ductile iron pipe and fittings to be cement lined and coated with bituminous material per AWWA.
  - Concrete cylinder pipe and fittings to be cement or cement-mortar lined and coated per AWWA.
  - Pre-insulated pipe system, Terra-Gard System by Perma-Pipe or approved equal
    - Copper carrier tube, ASTM B88, Type K, seamless, hard temper

- Steel carrier pipe to be ASTM A53, seamless, carbon steel, Schedule 40
- Polyurethane, closed cell insulation
- PVC jacket per ASTM D1784
- Valves – Buried
  - Chilled Water
    - Resilient seated gate valves for pipe up to 12”.
    - Butterfly valve for pipe over 12” conforming to AWWA C504 and Tucson Water Specification No. 1411
  - Heating Water
    - Butterfly valve conforming to AWWA C504 and Tucson Water Specification No. 1411
- Joint Restraint Devices
  - Ductile iron mechanical joints – Megalug joint restraint
  - Ductile iron flange connection –Megaflange joint restraint flange adapter
  - Integral ductile iron joint – TR Flex restrained joint
  - Concrete cylinder pipe - welded
- Valve Boxes – cast iron box and cover
- Air Relief Valve Vaults – cast in place concrete with 30” diameter cover
- Air Relief Valves – APCO Series 140C, cast iron body, SS float, SS lever, Buna –N seat

### **Part 3 - Execution**

- Chilled water piping
  - Ductile iron pipe to be installed per AWWA C600 and Tucson Water Standard Specification No. 1401.
  - Concrete cylinder pipe to be installed per AWWA M9 and manufacturer’s recommendations.
- Hot water piping
  - Installed per pre-insulated piping system manufacturer’s instructions
- Testing: Hydrostatic, no leakage permitted @100 psig, witnessed by UA Inspector before joints are concealed.

**End of Section 02610**

**DIVISION 2 – SITEWORK**

**Section 02620 – Site Potable Water and Reclaimed Water Utilities**

**Introduction**

Piping of site utilities

POTABLE WATER, RECLAIMED WATER

**Part 1 - General**

- Refer to Section 15050 common piping materials and methods.
- Refer to Section 15980 for meter requirements.

**Part 2 - Products**

- Pipe Schedule:

<u>Service</u>	<u>Size</u>	<u>Pipe</u>	<u>Fittings</u>	<u>Joints</u>
Potable and Reclaimed Water	Up to 3"	PVC-Sch. 40	PVC	Glued
	4" to 12"	PVC- C900 or Ductile iron	PVC Ductile iron	Push-on, mechanical jt
	Over 12"	Ductile iron	Ductile iron	Push-on, mechanical jt

- Pipe
  - Ductile iron pipe and fittings to be cement mortar lined (interior) and coated with bituminous material (exterior) per AWWA. Mortar lining for reclaimed systems shall be double thickness.
  - PVC pipe, AWWA C900.
  - Reclaimed Water- PVC pipe shall be purple (Panatone 522C). Ductile iron pipe shall be encased in purple polyethylene.
- Valves - Buried
  - Potable- For pipe over 12" Butterfly valve conforming to AWWA C504.
  - Reclaimed Water- For pipe over 12" Butterfly valve conforming to AWWA C504.
  - Resilient- Seat gate valves for pipe up to 12".
- Joint Restraint Devices
  - Ductile iron mechanical joints –Megalug joint restraint.
  - Ductile iron flange connection –Megaflange joint restraint flange adapter.
  - Integral ductile iron joint – TR Flex restrained joint.
  - PVC pipe – EBBA Iron Sales Series 1700.

- Valve Boxes – cast iron box and cover.
- Air Relief Valve Vaults – cast in place concrete with 30" diameter cover.
- Air Relief Valves – APCO Series 140C, cast iron body, SS float, SS lever, Buna –N seat.

### **Part 3 - Execution**

- Potable water
  - Installation shall be per Tucson Water Standards.
- Reclaimed water
  - Installation shall be per Tucson Water Standards.
- Testing- Hydrostatic, no leakage permitted@100 psig for 4 hours, witnessed by UA Inspector before joints are concealed.

### **End of Section 02620**

## **DIVISION 2 – SITEWORK**

### **Section 02640 - Site Natural Gas Utility**

#### **Introduction**

Piping of site utilities

NATURAL GAS

#### **Part 1 - General**

- Southwest Gas Corporation standards are applicable.

#### **Part 2 - Products**

- Piping and meters
  - Materials provided by Southwest Gas Corporation per its standards.

#### **Part 3 - Execution**

- Installation by Southwest Gas Corporation per its standards.
- Contractor to coordinate activities with Southwest Gas Corporation and provide adequate access to the site.

**End of Section 02640**

## **DIVISION 2 – SITEWORK**

### **Section 02710 – Site Sanitary Drainage**

#### **Introduction**

Piping of site utilities

#### **SANITARY DRAINAGE**

#### **Part 1 - General**

- Pima County (PC) Standard Specifications and Details are applicable.

#### **Part 2 - Products**

- Pipe Schedule

<u>Service</u>	<u>Size</u>	<u>Pipe</u>	<u>Fittings</u>	<u>Joints</u>
Sanitary	Up to 15"	PVC SDR-35	PVC	Bell & Spigot

- PVC pipe per ASTM D3034, SDR 35
  - PVC Fittings per ASTM D3034
  - Joints per ASTM D3212 with gaskets per ASTM F477

#### **Part 3 - Execution**

- Installation to conform with PC/COT Standards and Details
- Testing per PC/COT Standards and witnessed by UA Inspector

#### **End of Section 02710**

## DIVISION 2 – SITEWORK

### Section 02720 – Site Storm Drainage

#### Introduction

Piping of site utilities

STORM DRAINAGE

#### Part 1 - General

- Pima County/City of Tucson (PC/COT) Standard Specifications and Details are applicable.

#### Part 2 - Products

- Pipe Schedule:

<u>Service</u>	<u>Size</u>	<u>Pipe</u>	<u>Fittings</u>	<u>Joints</u>
Sanitary	Up to 18"	PVC SDR-35	PVC	Bell & Spigot
	larger than 18"	Reinforced Concrete	Concrete manhole	Gasket & mortar

- PVC pipe per ASTM D3034, SDR 35
  - PVC Fittings per ASTM D3034
  - Joints per ASTM D3212 with gaskets per ASTM F477
- Reinforced concrete pipe to conform with AASHTO M242
  - Concrete manhole materials shall comply with PC/COT Standards and Details
  - Joint materials shall comply with PC/COT Standards and Details

#### Part 3 - Execution

- Installation to conform with PC/COT Standards and Details
- Testing per PC/COT Standards and witnessed by UA Inspector

**End of Section 02720**



## **DIVISION 2 - SITEWORK**

### **Section 02810 – Irrigation**

#### **Introduction**

As with layout plans and details, specifications shall be coordinated with those of the other design team members. Electric power shall be supplied for controllers and water for the system.

As with layout plans and details, specifications shall be coordinated with those of the other design team members. Electric power and a phone line shall be supplied for the controllers and water for the system.

#### **Part 1 - General**

- Damage to existing systems or utilities shall be repaired and made good by the contractor.
- Existing irrigation systems serving plants that remain on site and beyond shall stay fully functional and be protected from damage during construction.
- Any irrigation equipment removed shall be salvaged to the University.
- Materials and installation shall be guaranteed for 2 years.
- Landscaped areas used as Contractor's storage yard and areas impacted by construction shall be restored to pre-existing condition at completion of project.

#### **Part 2 - Products**

- The following are preferred by the University:
  - Backflow Preventer - Febco, reduced pressure type (for domestic water supply connections).
  - Filter - Agrifim
  - Remote Control Valve (RCV) – Rainbird Pesb for potable systems. Rainbird Pesb with non-Potable handle for reclaim water systems.
  - Ball Valves - Brass body ball valves
  - Quick Coupling Valves (QCV) – Rainbird 33 DRC for potable system. Rainbird 33 DLRC for reclaim water systems. Also furnish 2 valve keys fitted with ¾" swivel hose ells.
  - Pressure Reducer - Senninger
  - Valve Box – Ametek with locking lid. Sizes for RCV; 10"X14"X15" deep. For sizes QCV's and gate valves; 9" dia. X 10" deep. On reclaim water systems all boxes shall be purple in color. On potable systems boxes shall be green in turf areas and brown/tan in planting areas.
  - Spray Head – Hunter series rotors. Rotors shall have purple tops when used in reclaimed water systems. Pop up heads shall be Toro 570z series with check valves.
  - Bubbler Head - Toro #FB-200 ADJ PC/89-0946 Screen
  - Drip Emitter – Rainbird zeribug emitters. XB-10 and XB-20 only.
  - Controller – "Calsense" controller only with radio remote and phone modem.
  - Polyethylene pipe - Distribution tubing size; .220". Drip system lateral size; .580" (nominal 1/2")
  - Polyethylene fittings –AG Products compression type #710cc. Male barbed-typed fittings are not permitted.
  - End Caps - AG Products #710cctc
  - Polyvinylchloride (PVC) pipe - Schedule 40 for pressurized lines, Class 200 for non-pressurized lines, Class 315 for non-pressurized, 1/2" dia. drip lines. Schedule 40 for all sleeves (I.D. of sleeves shall be a minimum of 1" larger than the O.D. of the pipe or wire bundle it will carry. Purple pipe shall be used on all main lines in reclaimed water systems.
  - PVC fittings - Schedule 40 by Spears
  - Threaded PVC nipples - Schedule 80

- Control and common wire - type THWN Neoprene insulated, single conductor; minimum wire sizes shall be as follows: common wire - 12 gauge, control wire - 14 gauge (12 gauge for runs over 1000').
- Splicing materials: Spears ds-400 prefilled connectors and Spears ds-300 sealer: line splices are allowed only on runs of more than 500'.
- Teflon tape - for threaded connections.
- Unions – Two schedule 80 unions shall be installed on all valve assemblies including master valve.
- Master Valve – All systems shall have a master valve wired to the controller after the P.O.C.
- Flow Meter – All systems shall have a “Calsense” flow meter installed down stream of the master valve. Flow meter shall be wired to the controller and compatible with central control system.
- Multi-port emitters – If multi-port emitters are to be used on the project they shall be Rainbird XBD-80'S. They shall also be enclosed in an “ECONO” emitter box, purple in color on reclaimed systems.

### Part 3 - Execution

- Formal Inspections with University present:
  - Layout (prior to trenching) of all piping, heads and other equipment.
  - Mainline trenches, mainline, water source point-of-connection and control wire valves, quick couplers, controllers, other equipment and electrical power connection.
  - Lateral piping and distribution tubing, spray heads, bubbler heads and drip emitters.
  - Final inspection upon completion of all work.
- Formal testing with University present:
  - Main line: tested for not less than four continuous hours at a static line pressure of not less than 100 PSI, with all isolation valves open, and all pipe uncovered.
  - Flush after installation of laterals and risers and test for watertightness and proper operation of lateral piping, filters, control valves, pressure regulators, end or run flush outlets and other equipment with all pipe uncovered.
  - Flush after installation and test for watertightness and proper operation of drip emitters and distribution tubing, spray heads, bubblers heads.
  - Final operational testing to demonstrate full coverage and proper function of automatic controls.
- Pipe and wiring shall be carried in separate Schedule 40 PVC sleeves under sidewalks and pavement with min. burial depths as follows:
  - Pipe and wires under pavement - 24"
  - Pressurized lines - 18"
  - Non-pressurized lines - 12"
  - Non-pressurized drip laterals - 8"
  - Wire - 12"
- Sleeves shall extend 12" beyond edge of sidewalk and/or pavement.
- Minimum clearances between irrigation lines adjacent to or crossing other irrigation lines or those of other trades shall be as follows:
  - 1" diameter and smaller: 6" horizontally, 3" vertically
  - Larger than 1" dia.: 12" horizontally, 6" vertically
- Excavations shall allow for 2" (min) of sand bedding or earth fill when rock or unsuitable bearing material is encountered. Provide and compact backfill as follows:
  - Sand bedding or approved earth fill to a point 6" above the top of pipe (for pipe under paving provide 4" minimum sand bedding on all sides).

- Approved fill free of lumps 1" in dia. and larger to 6" from the top of the trench.
- Approved topsoil, as specified elsewhere to the top of the trench.
- Snake pipe in trench to allow 1 additional foot per 100" of pipe.
- Holes bored beneath pavement shall maintain an alignment tolerance of no more than 1" in 10', both vertically and horizontally.
- Pipe shall be cut only with an approved pipe cutter. Cuts with a hacksaw or knife are not permitted. Holes for emitters shall be made only with manufacturers approved punch tool.
- Polyethylene pipe shall be inserted into fittings 1/2" min. Minimum radius of Poly. pipe bends shall be 18".
- Backflow preventers shall be insulated with aluminum tape.
- Install filter immediately downstream of backflow preventer and upstream of control valves.
- Provide thrust blocks for pipe 1-1/2" in dia. and larger.
- All main lines shall have a continuous trace wire laid with the pipe.
- Provide QCV's at 150' (max) spacing along the mainline or around the perimeter of the project, as necessary; install QCV's in valve boxes and on swing joint assemblies perpendicular to adjacent finished grade unless otherwise noted.
- Install RCV's perpendicular to adjacent finished grade unless otherwise noted; provide a minimum of 30" slack in control wires at control valves to allow servicing. Allow 2" clearance between control valves and gravel sump beneath.
- Install end caps in "econo" type valve boxes.
- Install RCV assemblies (RCV, Filter, pressure reducer, QCV, sensor) in valve boxes.
- Tie control and common wires in bundles at 10' intervals.
- Wire splices shall be made in valve boxes.
- Group valve boxes, install no closer than 6" to adjacent walls and not further than 12" from walks, curbs, etc. Install all valve boxes flush with finish grade. Support valve boxes on bricks (min. four) below grade. Provide gravel sumps 6" in depth (min).
- Equipment within valve boxes shall be 4" to 8" below lid and quick couplers no more than 3".
- Install spray heads on triple swing joints 6" from adjacent walks, curbs, mowing strips, etc. and with the top of the head flush with adjacent grade.
- Install bubbler heads on double swing joints and with the distance from the bottom of the head to adjacent finished grade set at 2".
- Distribution tubing leading from the drip emitter to the surface shall not exceed 5 feet in length, shall extend 2" above adjacent finish grade and shall be secured in the soil with an anchor created by wrapping the tubing twice around a 3" length of 1/2" PVC pipe and buried 8" below grade.
- Affix a non-fading, weather resistant copy of Irrigation Diagram and controller name label to inside of controller cabinet door. The Irrigation Diagram shall show all valves operated by the controller, valve sizes and type of planting irrigated.

- For future expansion add a minimum of 2 extra control wires to the furthest valve manifold in each direction.

**End of Section 02810**

## **DIVISION 2 - SITEWORK**

### **Section 02830 - Fences and Gates**

#### **Introduction**

The items listed below are unique to the University of Arizona requirements and shall be incorporated in to the specifications and drawings prepared by the Consultant.

#### **Part 1 - General**

- Refer to the Chain Link Fence Manufacturers Institute Voluntary Standards for Chain Link Fence Installation.

#### **Part 2 - Products**

- Fabric shall be 9 gauge, 2" weave w/ Class 2 hot dipped galvanized finish, w/ not less than 1.2 oz. of Zinc per square foot, applied before weaving, and with top and bottom selvages knuckled.
- Framing members (including post, rails, braces, gate frames) shall be Type 1 pipe, Schedule 40, hot dipped galvanized w/ not less than 1.8 oz. of Zinc per square foot of surface: posts and rails shall have caps to exclude moisture; rails shall be attached to posts w/ malleable rail end caps w/ 7/8" beveled steel brace band.
- Posts and rails shall be standard gauge steel pipe sized as follows:
  - Corner posts up to 6 feet tall: 2.375" O.D.; over 6 feet tall: 4.00" O.D.
  - Line posts up to 6 feet tall: 2.00" O.D.; over 6 feet tall: 2.375" O.D.
  - Gate posts for leaves up to 6 feet wide: 2.875" O.D.; for leaves from 6 to 13 feet wide: 4.00" O.D.
  - Gate frames: 2.00" O.D. structural grade pipe
  - Rails: 1.625" O.D. w/ 7" long (min.) mid-span expansion couplings
  - Tension wires: .177" O.D. marcelled steel tension wire w/ Class 2, galvanized coating

#### **Part 3 - Execution**

- Foundations shall be concrete with a 28 day compressive strength of 2500 PSI, constructed w/ top of footing 2" above adjacent finished grade and sized as follows:
  - Terminal posts: 16" dia. w/ 39" depth of post embedment
  - Line posts: 12" dia. w/ 39" depth of post embedment
- Terminal posts shall be braced with 1.625" O.D. rail installed between the midpoints of the post and the first line rail (in each direction at corners). Attach braces as rails; secure w/ .375" dia/ truss rods from line post to terminal post.
- Bottom of fabric shall be 2" above adjacent finished grade.
- Attach fabric to posts, rails, braces and tension wires at 15" o.c. (max); attach fabric to posts w/ tension bars and clips; stretch fabric between terminal posts or every 100'. whichever is less.
- Gate hardware for swing gates shall include three hinges per leaf, provisions for pad-locking with cast metal fork latch, drop bolt and drop bolt retainer; hardware for rolling gates shall include heavy duty track, ball bearing hangar sheaves, overhead framing and supports, guides stays, bracing and locking devices as desired.
- Gates shall be braced with midpoint bracing as for terminal posts and with a bottom rail.

#### **End of Section 02830**

## **DIVISION 2 - SITEWORK**

### **Section 02850 - Trash Compactor Embed Plan**

#### **Introduction**

The placement of a trash compactor on any project is a decision to be made by the University. (Either Facilities Management or Residence Life).

Trash compactors are strategically located throughout campus based on need and it's ability to serve several buildings.

#### **Part 1 - General**

- The trash compactor and associated container are provided by the City of Tucson, Sanitation Division.
- A concrete slab with embed plates and electrical power is to be provided per the attached drawing for all trash compactor installations.

#### **Part 2 - Products**

- No discussion.

#### **Part 3 - Execution**

- No discussion.

#### **End of Section 02850**

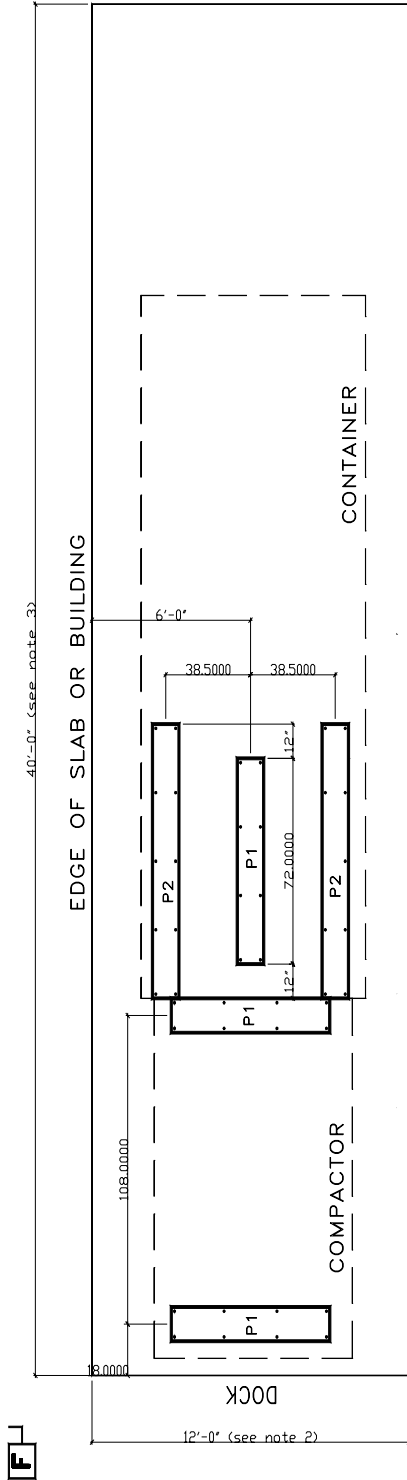

Steel Plate Section Typ.

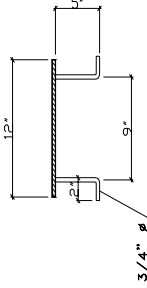

Steel Plate Measurements

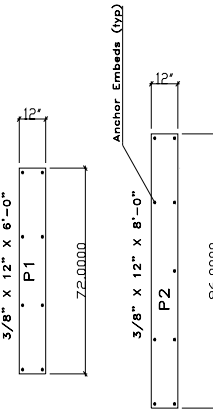

Notes

- 1) Trash compactor and container are provided by the City of Tucson.
- 2) Sanitation Division.  
allowable 10'-0" and a length of 5'-0" greater than the combined length of the compactor and receiver container. If should be of minimum 3,000 lbs. weight. The steel plate should be anchored at all anchor bolts. It is preferred to provide 2" clearance at all anchor bolts. If it must be raised above the surrounding ground level, the pad at the end opposite to the compactor should be raised 2" above the surrounding ground level. Provide adequate maneuvering room for the container handling vehicle. Allow a minimum of 45'-0" of clear space from the container-end of the pad for the container handling vehicle. The standard 40 CY container is 45'-0" long. Verify details and container size with the available. Verify details and container size with the available.  
City of Tucson  
Sanitation Division  
791-4822  
791-4822
- 3) Overall pad length is dependent on container size. The standard 40 CY container is 45'-0" long. Verify details and container size with the available. Verify details and container size with the available.  
City of Tucson  
Sanitation Division  
791-4822  
791-4822
- 4) A lockable fused disconnect switch must be installed and be within sight of the compactor's electrical panel box location, not to exceed 5'-0" from the compactor.
- 5) Disconnect Box must be wired for 3 phase, 230 volts at 60 amps or 480 volts at 30 amps.

UNIVERSITY OF ARIZONA	
MANUAL OF DESIGN SPECIFICATION STANDARDS	
STANDARD DETAIL:	TRASH COMPACTOR EMBED LAYOUT
DRAWN BY: R. DOMINGUEZ	DETAIL NO. 02850-D1
APPROVED BY:	REVISIONS
ACAD: D:\DSS\02850-1	

## **DIVISION 2- SITEWORK**

### **Section 02870 - Site and Street Furnishings**

#### **Introduction**

Benches, tables, bollards, bicycle racks receptacles, if appropriate to the facility, shall be included in the project. Generally these items shall be anchored in concrete so as not to be removed by vandals. Specify items which can be readily replaced if damaged.

#### **Part 1 - General**

- There are no unique University requirements in this section.

#### **Part 2 - Products**

- Benches - Dura Art Stone and Gametime "Ultrim" UF-3000. Concrete and perforated metals are preferred to wood and fiberglass
- Trash Receptacles - Form Products, 7-WCF-ATL. Do not locate on or above paved surfaces.
- Bicycle parking racks - ACI (Arizona Correctional Industries) Model MP 4113. Install below grade.
- Kiosks, bulletin boards. Must be all weather.
- Tree Grates - Neenah, Urban Accessories, Canterbury International. To be installed with frames.
- Drinking Fountains - Haws. Must be handicapped accessible
- Public and Emergency (blue light ) telephones. Must be handicapped (ADA) accessible. Emergency telephone shall be hands free operation by Talk-A-Phone, Model 400 - cfr Mushroom. Blue light fixture shall be combination type for both blue light and strobe operation.
- Building ID Signs. By University.
- Lighting. There are four basic types of exterior lighting found on the University campus: street light, area lighting, path lighting and lighting for special purposed (e.g. field lighting and sign lighting). University electrical engineers have reached an agreement with astronomers to the effect that, with rare exception, all exterior lighting shall use Low Pressure Sodium (LPS) lamps. Exceptions, such as sports fields and very deep overhangs, will be considered on a case by case basis. Equipment intended for permanent installation shall be heavy duty with a life expectancy of at least 50 years. Street and large area lighting may be most efficient and cost effective when using poles 30 feet tall. The following listing reflects the preferred choices for exterior lighting:
  - Street and area lights use fully shielded fixtures with LPS lamps.
  - Path lighting use 100% down lighting with small LPS lamps.
  - Special purpose lighting such as recessed wall mount step lights and surface mounted path lights shall use small LPS lamps with down louvers.

#### **Part 3 - Execution**

- There are no unique University requirement in this Section.

#### **End of Section 02870**



## **DIVISION 2 - SITEWORK**

### **Section 02900 - Landscaping**

#### **Introduction**

Designers are encouraged to use plant material in energy conserving, climate ameliorating ways. Combinations of deciduous and evergreen shade trees can do much to mediate weather and climatic extremes.

Designers shall refer to site paving drawings and coordinate size of plant pits so as to not undermine hardscape.

The addition of new lawns is restricted due to University agreements with the Arizona Department of Water Resources.

#### **Part 1 - General**

- Plant materials shall be selected from the most current revision of the Low Water Use/Drought Tolerant Plant List published by the Arizona Department of Water Resources, Tucson Active Management Area.
- Water harvesting measures should be considered where available.

#### **Part 2 - Products**

- Imported topsoil shall be Mesa Red natural, friable loam. Submit written evidence of tests for pH and total dissolved salts (TDS) prior to delivery. pH shall be between 6.5 and 8.0, TDS shall not exceed 1000 parts/million.
- Mulch shall be "Forest Magic" brand or other approved nitrogen stabilized (nitrolized) fine ground fir bark.
- Fertilizer shall be commercial Ammonium Phosphate w/an NPK ration of 16-20-0; use Agriform 20-10-5 formula, 21 gram tablets for salvaged and replanted plants.
- Soil sulphur shall be agricultural grade, pilled or granulated, containing 99.5% active and 0.5% inert ingredients.
- Manure shall be composted, well rotted, free of refuse and containing not more than 25% straw or other bedding material.
- Soil mix for backfilling shall be three parts topsoil to one part mulch with one pound Ammonium Phosphate and two pounds soil sulphur added per cubic yard.
- Tree stakes shall be three (3) inch diameter by eight (8) feet long, pressure-treated Lodgepole Pine, free of any weakening knots or other defect. Stake trees up to 15 gallon size with two (2) stakes. Larger sizes shall be staked or guyed.
- Guy wire shall be new, 12 gauge, annealed, galvanized.
- Chafing guards shall be new, 3/4" dia. reinforced rubber or vinyl hose, 12" long (min) or as necessary to protect tree from guy wires.
- Decorative rock "Desert Gold" or "Wildcat Red" in color, from a local source and shall consist primarily of particles 1/2" to 3/4" in diameter.
- Boulders shall be native Santa Catalina Mountain rock.
- Pre-emergent herbicide shall be "Surflan" or approved equal.

- Palm tying twine shall be natural fiber.

### **Part 3 - Execution**

- New and existing utilities shall not conflict with planting.
- Where plant material will be placed in soil beneath existing pavement, especially asphalt pavement, or other condition where soil sterilant or other treatment potentially harmful to plant material may have been applied shall be tested for the presence of any such chemicals or condition. Affected soils shall be treated and/or excavated and disposed of in accordance with local codes.
- Minimum planting pit sizes shall be as follows:
  - One (1) gallon size container: 18" in dia.
  - Five (5) gallon size container: 36" in dia.
  - Fifteen (15) gallon size container: 60" in dia.
  - Twenty four (24") inch box. 60" square.
  - Thirty six (36") inch box and larger. 18" clear on all sides.
  - Depth of all pits no deeper than the rootball to prevent settling.
- Plant pits shall not undermine hardscape nor shall hardscape elements be placed over plant pits.
- Areas to receive ground cover plants shall be excavated in their entirety to 18" below finish grade and backfilled with backfill mix described above.
- Planting pit percolation rates to be determined prior to planting in the presence of U of A representative.
- After water settling backfill, set plants lower than finish grade to create irrigation basins such that the crown of the root ball shall be 4" lower than surrounding finish grade. Basins shall be as wide as the plant pit. Top of rootball shall be flush with finish grade of the basin.
- 2" of mulch shall be incorporated into the top 3" of soil in irrigation basin areas.
- Root balls of existing palm trees to be transplanted shall have a minimum diameter of 4 feet plus the diameter of the trunk measure 12" above the ground. Vitamin B-1 shall be used per manufacturer's recommendations with the first watering.
- Salvage of existing trees from the project shall be performed by a firm approved by the University and with at least four years experience with this type of work. The work shall be guaranteed and conducted in a manner consistent with local practice. The University shall designate a holding area and source of irrigation for boxed or other wise temporarily stored trees.
- Restoration of turf operations shall include: loosening compacted soil to a minimum depth of 9", removing all rock and debris 1" and larger and adding approved topsoil to match original grade and compaction. 3" of composted, screened, weed free manure plus 2 pounds of Ammonium Phosphate (16-20-0) and 5 pounds of soil sulphur shall be added per 100 square feet and roto-tilled into existing soil to a depth of 6". Between the dates of May 15 and August 15, sow Cynadon dactylon (common Bermuda grass) seed at a rate of 3 pounds per 1000 square feet. Seed shall be 98% pure and have a germination rate of 75%. Between August 15 and May 15, contractor shall provide to the University, but not sow, the appropriate quantity of seed. Roll seeded areas with a 50 pound per linear foot roller then mulch with one-half inch of screened manure.
- The landscape contractor shall maintain all planting until accepted. Maintenance operations shall include: watering, mulching, tightening or adjusting of tree ties, resetting plants to proper grade, restoration of irrigation basins, fertilization and weeding. Replacement materials shall meet all specifications of original materials.

- Where existing lawns have been damaged by construction and are to be repaired by the contractor, follow these instructions:
  - Loosen compacted soil to a depth of 9" min.
  - Remove debris and rock larger than 1" and all contaminated soil.
  - Add topsoil to the level of original grade and allow for settlement.
  - Rototill into the top 6" a 3" layer of manure, 2 pounds Ammonium Phosphate (16-20-0) and 5 pounds of soil sulphur per 100 sf.
  - Broadcast Bermuda grass seed (98% pure, 75% germination) at the rate of three pounds per 1000 sf and cover with a thin layer of manure.
- Sod shall be cut, delivered and installed within a 24 hour period. Cultivate subgrade to a depth of 6" prior to placing topsoil and remove all stones and debris 1" and greater in dia. Place topsoil to a depth of 9" over cultivated subgrade. Topsoil shall consist of equal parts topsoil, sand and manure with 18 pounds soil sulphur, 50 pounds gypsum and 7 pounds Ammonium Phosphate fertilizer (16-20-0) added per 1000 sf.
- Maintenance for new or reestablished turf areas shall be as follows:
  - Maintenance period shall be for 90 days or a minimum of four mowings, whichever is longer, Turf shall be mowed to a height of 1/2" when a height of 1" is reached.
  - Spray heads shall be set 1" above finished grade, initially and reset once turf is established by the contractor at no additional cost. Irrigation shall not result in wilting, puddles or runoff.
  - After 3 weeks and again at the end of the maintenance period, fertilize with a fertilizer that provides one pound available Nitrogen per 1000 sf.
  - Final acceptance will occur with a satisfactory stand of grass (solid, healthy growth, without bare spots) at the end of the maintenance period.
- Palm ties, not broken naturally, shall be cut by contractor after 4 months.
- Berms and swales shall be formed as continuous, smooth landforms with no obvious top or bottom to slopes or grade change from berm to swale.
- Install decomposed granite (DG) 1-3/4" to 2" deep, rake smooth and tamp with a roller of 100 pounds per linear foot weight, minimum. Finish grade shall be 2" below top of adjacent walks, curbs or other pavement. Apply per emergent herbicide, per mfg, instruction, before and after placing the D.G.
- Provide positive drainage away from buildings and structures. Direct runoff water to planting areas.
- All plant materials shall be guaranteed for 1 full year following substantial completion or replacement.

**End of Section 02900**

## **DIVISION 3 - CONCRETE**

### **Section 03310 - Structural Concrete**

#### **Introduction**

Drawings shall be coordinated between the various other sub consultants to avoid field problems with openings, shear walls and structural slabs. Drawings shall show special reinforcement required at openings. Drawings shall show location of construction, expansion and contraction joints.

#### **Part 1 - General**

- ACI references shall be comprehensive to cover the requirements needed.
- For special or critically flat floor slabs- use FF & FL numbering system set forth in ACI117 & ASTM E1155 for floor flatness/levelness.
- Concrete testing
  - Less than 50 cu yds - by Contractor
  - Greater than 50 cu yds - by U of A with a retesting charge for concrete not meeting specification.
- Mock-up should be provided for any structural concrete that is to receive a finish treatment such as a sandblasted, exposed aggregate or bush hammered finish. Any special finish treatment should be specified in Section 03330 Architectural Concrete. Mock-up shall not be incorporated into the final work.

#### **Part 2 - Products**

- Form materials. Metal or wood should be specified.
  - Wood forms: Specify grade and thickness of plywood form material. Limit reuse to 3 times  
Exposed concrete - Use HDO plyform.  
Unexposed concrete - Use AC plywood.
  - Column forms: Specify metal, fiberglass or sonotube (lined or unlined). These types are not equal. Seam placement should be considered to insure workmanship-like patch if in finished area.
  - Pan forms. Specify specific type (steel, glass-fiber or reinforced plastic). These types are not equal and provide different finishes. Although discouraged, if underside is to be left exposed, pans are to be in "like new" condition.
  - Fiberglass grip form ties shall not be allowed.
- Rebar - if required to be welded, the appropriate type should be specified.
- To alleviate flooring material concerns associated with moisture transmission and emission through concrete slabs on grade the following preventive measures shall be prescribed.
  - An under slab vapor barrier should be specified and detailed directly under the concrete slab and on top of any subgrade or sand grading material to minimize moisture transmission through the slab. Vapor barriers shall meet the requirements ASTM E-1745 Class "C". Acceptable vapor barriers are "Stego Wrap" by Stego Industries and "Moistop Plus" by Forfiber Building Products Systems.
  - A low water to cement ratio, low slump concrete should be specified for all interior slabs where flooring is anticipated to minimize the amount of free water in the concrete. Sufficient time should be allowed with the project to allow the emission of any free moisture to evaporate from the slab.
  - Surface sealers such as "Para-Seal" by Parabond may be considered for re-flooring applications on existing slabs.

- Curing compounds and form release agents shall be non-staining and be compatible with the wall and floor finishes specified. Once selected for a project, they shall be used for the entire project.
- Sealers on exposed interior concrete floors shall be compatible with Waxie "Floorstar".
  - Penetrating sealers (silicon, epoxy, etc.) shall not be used when a custodial effort is intended to maintain the finish of the floor.
  - Sealer or finish should be applied immediately after the dissipation of the curing compound in order to protect floors during construction and then cleaned and reapplied prior to final acceptance.
- Minimum concrete compressive strength shall be 3000 psi. Provide a detailed concrete mix schedule if more than one strength or type is required for the project.

### **Part 3 - Execution**

- Column penetrations through slabs shall initially be blocked out in a diamond shape and infilled afterwards.
- Sandblasted or exposed aggregate finishes should be specified in Architectural Concrete. To achieve a uniform sandblast finish, special concrete mixes and forming practices are required, i.e., water tight forms.
- Slabs shall be depressed (dished) ½" deep around all floor drains.

**End of Section 03310**

## **DIVISION 3 - CONCRETE**

### **Section 03330 - Architectural Concrete**

#### **Introduction**

In general, all of the items included in Section 03310 - Structural Concrete, will apply. This section shall be included when concrete will be exposed and special finishes may require non-standard formwork, special design mixes (for color or texture) and services of a specialized consultant to assist the Contractor in providing the required design results.

All of the above items should be considered if special finishes are desired. Attempts to get them without the benefit of special attention and/or an expert in this field will result in poor quality, compromised design and possibly additional charges on the part of the Contractor in connection with efforts to provide what was not specified or detailed.

Drawings must be very specific concerning the detailing for Architectural Concrete. The special features should be noted in the specifications and on the drawings. Descriptions such as "glass like", "polished", "light sandblast" finishes are considered as being ambiguous unless adequately specified in this Section.

#### **Part 1 - General**

- Typical examples of work in this section include exposed aggregate surfaces (whether water washed or sand blasted), bush hammered, textured, colored, and specialized forming.
- Requirements for structural concrete work are not to be used for Architectural Concrete. Reference ACI Standards.
- Submittals shall be required as appropriate for color additives, aggregate, formwork details, special form ties, curing agents, retarders, form release agents and the like. These items will all effect the final appearance of the concrete.
- Mock-ups shall be required for approval before work is incorporated in the building. Size and configuration of the mock-up is important to fully evaluate all anticipated construction details. Mock-up shall not be incorporated into the final work.

#### **Part 2 - Products**

- Generally, architectural finish on concrete is associated with watertight formwork.

#### **Part 3 - Execution**

- Anticipate the fact that sandblasting is a very disruptive and messy activity that is not easily accomplished in many areas of campus. Compliance with Pima County air pollution standards will also be a requirement of the specification.

#### **End of Section 03330**

## **DIVISION 4 - MASONRY**

### **Section 04200 - Unit Masonry**

#### **Introduction**

Red brick is used almost exclusively for exterior masonry elements and its appearance is important toward maintaining campus unity.

#### **Part 1 - General**

- For all new and infill masonry work adjacent to existing walls, require that a 3' x 3' mock up wall be constructed to insure that both the brick and the cured mortar colors are satisfactorily matched. Require minimum of 3 week curing time for evaluation of the mortar color.
- On new construction a similar appropriately sized mock up should be constructed to establish the standard of acceptance for all elements of the work, i.e., mortar color, flashing, coursing, pattern, control joints, accessories, etc.
- The tops of all exposed masonry walls shall receive a watertight cap, i.e., sheetmetal or precast concrete, to prohibit moisture infiltration and efflorescence.
- To minimize brick color variations, the project should be fired and supplied in one continuous run. If variations in color exist within the run, the differently shaded bricks shall be randomly intermixed as the wall is constructed. Obvious delineations in the brick color are not acceptable.

#### **Part 2 - Products**

- Selected brick color shall be as available from local southern Arizona suppliers.
- The use of mortar or grout admixtures, other than color pigments, shall not be allowed. Specifically prohibit the use of any mortar retarding agents due to their unpredictable nature.
- Mortar shall be consistently patched. Use pre-mix from patch plant or use gauge boxes on-site. The use of the shovel method for measuring and batching mortar mixes should be discouraged.

#### **Part 3 - Execution**

- Tolerances: Masonry work that does not conform to the following tolerances shall be repaired or replaced as directed by the Architect. Tolerances are based on ACTUAL DIMENSIONS.
  - Variations from plumb:
    - In lines or surfaces of columns, walls, and arises: in 10 feet - ¼"; in any story or 20 feet maximum - 3/8"; in four stories or more - ½".
    - For external corners, control joints and other conspicuous lines: in any story or 20 feet maximum - ¼"; in 40 feet or more - ½".
  - Variations from the level or the grades indicated on the drawings:
    - For exposed lintels, sills, parapets, horizontal grooves and other conspicuous lines: in any bay or 20 feet maximum - ¼"; in 40 feet or more - ½".
  - Variation of the linear building lines from established position in plan and related portion of columns, walls and partitions:

- In any bay or 20 feet maximum -  $\frac{1}{2}$ "; in 40 feet or more -  $\frac{3}{4}$ "
- Variation in cross-sectional dimensions of columns and in the thickness of walls is plus or minus  $\frac{1}{4}$ ".
- The type of mortar joint should be specified. Tooled joints are preferred. Raked and flush joints are discouraged.
- Masonry anchoring
  - Anchor spacing to structural members shall be indicated, but not more than 24"o.c. vertically and 36"o.c. horizontally.
  - Anchor spacing to metal studs (single wythe masonry) shall be indicated, but not more than 16"o.c. vertically and 24"o.c. horizontally with not less than one anchor for each 2 sq. ft. of wall area. Install additional anchors within 1'-0" of openings and at intervals around perimeter not exceeding 8".
- Control Joints

Install control and expansion joints in unit masonry at 20' maximum. Joint width shall be not less than  $\frac{3}{8}$ " for installation of backer rod and sealant.
- Lintels

Provide masonry or steel lintels where shown and/or wherever openings are more than 1'-0" wide for brick size units and 2'-0" for block size units. Provide steel, precast or formed-in-place masonry lintels for all larger openings. Cure precast lintels before handling and installation. Temporarily support formed-in-place lintels.

**End of Section 04200**



## **DIVISION 5 - METALS**

### **Section 05300 - Metal Decking**

#### **Introduction**

Metal decking is a straightforward structural specification with limited University requirements.

#### **Part 1 - General**

- Specify type of attachment to structure, i.e., screws or puddle welding.
- Be aware that many metal deck manufacturers do not allow attachment of suspended loads to the underside of their metal deck. Unless engineered differently, all ceiling, framing, mechanical, plumbing and electrical supports shall be attached to the structural framing members only.
- Verify that metal deck priming or galvanizing is compatible with fireproofing when applicable.

#### **Part 2 - Products**

- There are no unique University requirements.

#### **Part 3 - Execution**

- There are no unique University requirements.

#### **End of Section 05300**

## **DIVISION 5 - METALS**

### **Section 05500 - Metal Fabrications**

#### **Introduction**

This Section applies to all miscellaneous metal items such as lintels, embeds, grating, ladders, handrails, stairs, bollards, nosings, trim and similar architectural features.

#### **Part 1 - General**

- Metal pipe bollards shall be a minimum of 6" diameter.

#### **Part 2 - Products**

- Metal bar grating shall be capable of withstanding a minimum uniform load of 250 psf or a concentrated load of 650 lbs.
- Grout and anchoring cement shall be non-metallic, non-shrink type.
- Consider abrasive metal stair nosings for all stairways especially those that are exterior.

#### **Part 3 - Execution**

- Welds shall be ground and sanded smooth for uniform painted appearance. The use of "Bondo" to fill large gaps and holes is discouraged.
- All sharp corners shall be radiused a minimum of 1/8"
- The use of expansion bolts to secure metal railing assemblies is discouraged. Anchorage should consist of direct embeds (cored holes, sleeves or plates) and/or welding.
- The use of metal pans for exterior stairs is discouraged and shall only be used with the approval of the UA Project Coordinator. When used in an exterior application all metal pans and other associated metal stair components shall be galvanized or 100% seal weld with all metal pan surfaces epoxy painted prior to infilling with concrete to alleviate the development of rust on any hidden or confined surfaces.

**End of Section 05500**

## **DIVISION 5 - Metals**

### **Section 05700 – Ornamental Metals - Skateboard Deterrents**

#### **Introduction**

Destruction and degradation of architectural edges due to skateboarders, skaters and BMX bicycles is an ongoing problem at the University. Where possible, integrating deterrents into the architectural design is preferred. This can be done many different ways - with uneven edges, recesses, ground textures, railing design etc. Otherwise, specify appropriate metal skateboard deterrent systems whenever edges and surfaces create temptations. The University recognizes that not all conditions that create opportunities for skateboarders, skaters & BMX'ers can be foreseen or prevented.

#### **Part 1 - General**

- Generally, railings, concrete edges, brick edges, tile edges, concrete benches, seatwalls, and protruding ledges should be evaluated for application.

#### **Part 2 – Products**

- Metal Skateboard deterrents – past projects have utilized products from Barco Products. Similar products from other manufacturers may also be specified.

Barco Products  
1-800-338-2697  
[www.barcoproducts.com](http://www.barcoproducts.com)

#### **Part 3 – Execution**

- No discussion

**End of Section 05700**

## **DIVISION 6 - WOOD AND PLASTICS**

### **Section 06000 - General Discussion**

#### **Introduction**

This General Discussion Section contains material which is important to successful millwork, wood framing and wood structural installations, in construction projects. The issues are fundamental to the basic design of the project, and the long term success of those elements of the project, as well as the fabrication and installation process.

#### **General Carpentry and Wood Design**

Although not a material of choice for exposed conditions in our desert climate, wood is used extensively as a building material. When used in University projects and in structural conditions requiring structural design and/or calculations, Consultant shall use a professional structural engineer currently registered in Arizona. Installations shall be by contractors and tradesmen skilled in framing and carpentry work.

#### **Architectural Woodwork / Custom Casework**

Because the University anticipates a longer than average building life and higher than average use and abuse, durable, high quality architectural woodwork (millwork) is essential to the long term success and serviceability of any project. Section 06402 - Architectural Woodwork / Custom Casework specifies current Standards of the American Woodworking Institute (AWI) but modifies the standard to omit the use of certain materials in certain conditions and in certain portions of the work. Although used extensively industry wide, in the experience of the University, these materials have proven unsatisfactory and must be specifically excluded from the specifications.

#### **Laboratory Casework**

These Standards differentiate between Architectural Woodwork / Custom Casework and Laboratory Casework because of the specialized nature and use of the product. Laboratory Casework shall be specified separately in **Division 12 Furnishings**. Additional standards are cited and specific pre-approved fabricators and manufacturers are listed. Also, it may be necessary to include additional sections in **Division 11 Equipment** to cover acrylic counter tops, laboratory bench tops and surfaces for acid and chemical resistance and for Laboratory Fixtures.

#### **End of Section 06000**

## **DIVISION 6 - WOOD AND PLASTICS**

### **Section 06100 - Rough Carpentry**

#### **Introduction**

No Discussion

#### **Part 1 - General**

- Submittals shall not be required if drawings sufficiently describe products unless special attention is desired by the Consultant, or the Project Manager.
- Submittals requiring structural design or calculations shall be sealed by a professional structural engineer currently registered in Arizona.
- Indicate and coordinate on plans and specifications all required solid blocking at all wall hung fixtures, door stops, cabinets, shelves and similar items.

#### **Part 2 - Products**

- Roof sheathing shall be a minimum of 5/8" thick, Structural 1 Exterior Plywood over trusses or joists at 16" or 24" spacing. At 24" spacing "ply-clips" shall be required.
- Fire Retardant Treated Lumber and plywood shall be specified and provided as required by Code and construction type.

#### **Part 3 - Execution**

- Installations shall be by contractors and tradesmen skilled in carpentry work.

**End of Section 06100**

## **DIVISION 6 - WOOD AND PLASTICS**

### **Section 06170 - Pre-Fabricated Structural Wood**

#### **Introduction**

No Discussion

#### **Part 1 - General**

- Submittals shall be required for all prefabricated wood trusses including shop drawings, erection drawings, bracing and calculation.
- Submittals requiring structural design or calculations shall be sealed by a professional structural engineer currently registered in Arizona.

#### **Part 2 - Products**

- Trusses with metal webs and laminated timber top and bottom chord members are preferred, and joists, other than dimension lumber, are preferred to be the plywood web type with laminated wood top and bottom chord members. "Gang-Nail" type trusses are discouraged.
- Glue Laminated structural members shall conform to the standards of the American Institute of Timber Construction (AITC). Designer must take care to differentiate between appearance and concealed grades of structural members.

#### **Part 3 - Execution**

- Installations shall be by contractors and tradesmen skilled in carpentry work.

**End of Section 06170**

## **DIVISION 6 - WOOD AND PLASTICS**

### **Section 06200 - Finish Carpentry**

#### **Introduction**

Consideration shall be given to the use of wood base, in lieu of the usual rubber base, in high use areas where equipment might impact and damage walls. Also consider chair rails for wall protection where appropriate.

#### **Part 1 - General**

- Finish Carpentry and Interior Architectural woodwork shall be fabricated to current Standards of the American Woodworking Institute (AWI). In most circumstances the requirements of "Finish Carpentry" may be combined with Section 06402 - Architectural Woodwork rather than in a separate section.

#### **Part 2 - Products**

- All Architectural Woodwork shall be "Custom" grade (or better as may be required) according to the American Woodwork Institute (AWI) and subject to the following:
  - No particle board or particle board core plywood may be used in any part of the work.
  - Plywood shall be industrial quality.

#### **Part 3 - Execution**

- Installations shall be by skilled tradesmen. In the cases where fabricator and installer are not one and the same, product and project guarantee shall not be compromised.

#### **End of Section 06200**

## DIVISION 6 - WOOD AND PLASTICS

### Section 06402 - Architectural Woodwork / Custom Casework

#### Introduction

These standards differentiate between Architectural Woodwork/Custom Casework and Laboratory Casework because of the specialized nature and use of the product. Laboratory Casework shall be specified separately in **Division 12 - Furnishings**.

#### Part 1 - General

- *Reference the following standards as applicable:*
  - *Architectural Woodwork Institute (AWI) Quality Standards, current edition.*
  - *ANSI/BHMA A156.9 – Cabinet Hardware.*
  - *NEMA LD3 – High Pressure Decorative Laminate.*
- In most circumstances the requirements of Section 06200 - Finish Carpentry may be combined with this section rather than in a separate section.

#### Part 2 - Products

- All Architectural Woodwork shall be “Custom” grade according to the American Woodwork Institute (AWI) and subject to the following *additional criteria*:
  - No particle board or particle board core plywood may be used in any part of the work except laminate tops discussed below, and shall be specifically excluded. (Laminate tops as discussed below excepted.)
  - Plywood shall be *all hardwood veneer core*.
  - High density formaldehyde free wood fiber board may be considered for use in lieu of plywood for laminate tops in dry areas on the Main Campus if approved by the Project Manager. Water resistant phenolic resin particle board may similarly be considered for wet areas if approved by the Project Manager.
  - Millwork shall be opaque or transparent finish rotary cut uniform color light birch hardwood (unless otherwise approved by the Project Manager). Architect shall specify finish and call for sample submittal for review and approval. Interior of millwork shall receive opaque or transparent finish to match exterior.
  - Plastic Laminate Clad Millwork may be used only if approved by the Project Manager. Doors and drawers shall be fully clad including inside faces of doors.
  - Minimum grades for plastic laminates shall be as follows (NEMA / ISO / Inch Thickness): For horizontal surfaces use HW62/HCS/.062” or GP50/HGS/.050” and for vertical surfaces use BK50/BGS/.050”. Do not specify post forming grades of laminates. Specify color or series if known.
    - Approved manufacturers of plastic laminate are:
      - Wilson Art
      - Formica
      - Nevamar
      - Pionite
- Approved manufacturers of Solid Surfacing Material Tops are:
  - Corian
  - Formica Surell
  - Pionite ChemGuard



- Hardware shall be indicated in a schedule in this section or in Section 08710, Finish Hardware. If in Section 08710, reference to that section.
  - Drawer glides shall be heavy duty rated.
  - Hinges shall be concealed type full metal with no plastic parts.
  - Hardware for adjustable shelves on walls shall be Heavy duty type equal to the K-V standard and bracket system.
  
- Approved hardware manufacturers are:
  - McKinney
  - K&V
  - Blum
  - Stanley
  - Gras
  
- Plastic laminate tops and back splashes are to be fabricated using  $\frac{3}{4}$ " plywood unless approved otherwise. Edges and joints shall be tight, glued and sealed. Post formed tops and splashes are not allowed. In those areas where sinks are applied to the underside of counter tops the tops shall be fabricated from 7 ply birch plywood (3/4" minimum) with an "A" surface one side. Do not use water based laminate glues on any counter top.

### **Part 3 - Execution**

- *Fastening devices and their attachment shall be submitted for approval prior to installation. Drywall screws will not be allowed for the attachment and installation of millwork.*
  
- Fabricate case bodies with stop dadoes if transparent finish.
  
- All "Custom" grade millwork concealed surfaces shall be treated at the shop with spray or brush application of 50% Pentacholorphenol solution in a 1:10 mixture with deodorized spray base. In the field all concealed scribed and cut surfaces shall receive a brush application of the same material.
  
- Drawers shall be lock shouldered or multiple dovetailed and have applied fronts. Bodies shall be hardwood or 7 ply plywood. Bottoms shall be hardwood panel product or masonite hardboard full or stop dadoed. Exposed surfaces shall be hardwood. All drawers shall ride on full suspension drawer glides, not wood keels.
  
- Shelves shall be edged plywood or solid lumber. Janitor and storage room shelving shall be AWI "Economy" grade except no particle board is allowed.
  
- Indicate requirements for utility provisions which must be coordinated by the fabricator.
  
- Plastic laminate application shall be specified as follows:
  - Apply side edging first, then top surface, with top surface overlapping side edging.
  
- Installations shall be by skilled tradesmen. In the cases where fabricator and installer are not one and the same, product and project guarantee shall not be compromised.

### **End of Section 06402**

## **DIVISION 7 - THERMAL AND MOISTURE PROTECTION**

### **Section 07000 - General Discussion**

#### **Introduction**

This General Discussion Section contains material which is critical to successful moisture protection systems in new construction and renovation, but which is not the sole responsibility of any individual trade. In many cases, the issues involved are fundamental to the basic design of the project, and the success or failure of the moisture protection concept is determined at the very outset of the design process.

The Consultant is expressly responsible for incorporating these overall requirements into the project, and for ensuring that all subconsultants are aware of the requirements and incorporate them into their designs as well.

Reliance on "after-the-fact" material selections to compensate for a problematic design decision is unacceptable.

#### **Below Grade Spaces**

- Below grade spaces are high-risk, expensive designs. Wherever possible, avoid
  - The use of finished below grade spaces requiring drainage systems and wall waterproofing
  - Planters above or adjacent to basement areas
- FDC actively discourages below grade elements in University projects. Designs incorporating below grade finished spaces will receive the strongest scrutiny during the programming and conceptual design phases. Be prepared to thoroughly document the unavoidable need for such elements.
- The University has experienced numerous instances of subsurface moisture working through concrete floor slabs on grade and destroying floor finishes. This seems mostly to be problem with below grade spaces. Ground floor slabs on grade have, so far, been safe from this condition. To ensure that this situation does not arise again, provide an impermeable moisture barrier under all slabs on grade.
- Wherever below grade walls are exposed to naturally flowing groundwater or substantial landscape irrigation water, even if simply foundation walls, include a foundation drainage system in addition to dampproofing or waterproofing the walls.

#### **Traffic Decks**

- Traffic bearing decks are very difficult and expensive to successfully waterproof and maintain. Wherever possible, avoid use of finished spaces with traffic decks exposed to the weather above them.
- FDC actively discourages use of such elements in University projects. Designs incorporating horizontal traffic decks will receive the strongest scrutiny during the programming and conceptual design phases. Be prepared to thoroughly document the unavoidable need for such elements. Failing such documentation, the Consultant will be directed to revise or even start completely anew the design.
- *Special attention should be given to ensure that all horizontal traffic surfaces provide appropriate slip resistance.*

#### **Roof Design**

- Do not design roofs which are intended to serve as walking surfaces for user functions. Activities which must be conducted on the roof top (e.g. astronomical or weather observations, greenhouses, etc.) require a design which incorporates platforms, penthouses or similar special enclosures.
- Similarly, do not design roofs which are required to be used as working platforms for maintenance of mechanical and electrical equipment. Enclose such elements in a penthouse.

- Avoid wherever possible use of conduit and piping installed on top of the roof.
- Any mechanical or electrical equipment which must be installed on the roof must be installed on either a prefabricated curb or a field fabricated platform. Where the top surface of such curbs and platforms is not completely covered and waterproofed by the actual equipment, the top surface must be a solid sheet metal cap. Design must meet OSHA workspace and fall precaution criteria.
- Installation of any type of roof top mechanical or electrical equipment on sleepers is not acceptable.
- Wherever possible, make the basic roof slope, and the slope of the crickets to the drains, part of the structural system (slope the structure). Avoid as much as possible thickness of roof insulation greater than 2". By sloping the structure, it will be possible to eliminate use of lightweight concrete fill altogether.
- Dead flat roofs are not acceptable.
- Design for a slope of 3/8" per foot, throughout the field of the roof and for all crickets, at the time of construction. Ensure that anticipated deflections and proposed cambers will result in a minimum slope of 1/4" per foot throughout the life of the facility.
- Space drains so that slopes in cricket valleys are at least 1/8" per foot.
- Provide metal or wood framing and sub-framing for large crickets. Cricket surfaces must be able to accept live loads similar to those of the basic roof deck.
- Small crickets up-slope of equipment curbs must maintain 1/8" per foot slope in their valleys, and may be fabricated of tapered insulation, not to exceed 4" thick.
- Design the project to allow for one complete re-roofing without removal of the existing roof system, should the University decide to do so. This includes:
  - Structural load capacity
  - Camber and deflection
  - Parapet heights
  - Joints, drains, and flashings
- Ensure that the design makes adequate allowance for proper flashing of perimeters and penetrations. Sufficient vertical dimension to install the cant strip, base flashing, counterflashing, and coping, will result in a parapet at least 18" above the finished roof at the highest point of the roof slope. Include a specific detail in the construction documents. This includes:
  - Parapet walls
  - Partial roof structures
  - Equipment curbs and platforms
  - Door and window sills
- Do not assume that base flashings and counterflashing can be successfully nailed into concrete or masonry. Provide a 3/4" plywood nailer at all parapets.
- Do not use interior roof drains without the specific permission of the Project Coordinator. When unavoidable, provide positive overflow drainage, preferably with a scupper through the parapet wall to daylight, or with a complete separate parallel overflow drain system.
- Design all roof drains and overflow drains in a depressed sump.

- Reroofing must comply with the requirements for new installations as much as possible. The Consultant is responsible for preparing complete details and specifications for the required reroofing work.
- Roofing repairs (e.g. installation of a new exhaust fan), must comply with the requirements for new installations as much as possible. The Consultant is responsible for preparing complete details and specifications for the required repair work. Generic notes such as "flashing as required" are not acceptable. While the University is not interested in telling the Consultant whether the Architect or the Mechanical Engineer should prepare the details and specifications for this type of repair, the information must be thorough and complete regardless of the author.

**End of Section 07000**

## **DIVISION 7 - THERMAL AND MOISTURE PROTECTION**

### **Section 07100 - Waterproofing and Dampproofing**

#### **Introduction**

Waterproofing and dampproofing are not interchangeable materials. Project may have one, both, or neither.

Waterproofing is a relatively secure system, and is used on surfaces which enclose habited space and where moisture penetration is not acceptable.

Dampproofing is a less restrictive system, and is used to reduce moisture migration through exterior surfaces such as retaining walls and planters.

Where such surfaces are intended to be subject to foot traffic, and therefore are not "roofs", refer to the requirements of Section 07590 Horizontal Traffic Surfacing.

Pay particular attention to the drainage course against the wall and to perimeter drains. Describe requirements for these elements on the drawings.

This is a section where the consultant should use a "performance specification". Do not specify proprietary manufacturer's names or materials, and do not restrict vendors to a limited list.

#### **Part 1 - General**

- Require that materials manufacturer(s) and installer(s) demonstrate 5 years of successful installations of similar systems.
- Require submittal of manufacturer's literature describing the system, and samples of proposed membrane materials.
- Require a pre-installation conference, scheduled after the substrates are complete, and including the Contractor, Architect, Owner, materials manufacturer, and installing subcontractor(s).
- Specify expanded warranties as follows:
  - 5 year warranty from the installer covering defects in installation
  - 10 year warranty from the materials manufacturer including defects in materials and installation, and guaranteeing to maintain the system in a waterproof or dampproof condition (as applicable) for the life of the warranty
  - Include sealing of all perimeters, joints, and penetrations
  - Renewal option for an additional 10 years from the materials manufacturer
  - Full replacement value without proration
  - Both furnished on the University's special warranty form

#### **Part 2 - Products**

- Expressly prohibit the use of asbestos-containing materials.
- Require that all materials be supplied by a single manufacturer, or approved by the primary materials manufacturer, to ensure single-point responsibility for the installation and warranty.
- Specify a waterproofing system which includes the following:
  - Joint preparation
  - Continuous self-healing sheet membrane, or

- Fluid-applied membrane which cures in place to form a continuous monolithic self-healing membrane
- Termite-resistant protection board embedded in a fluid-applied coating to prohibit displacement
  
- Specify a dampproofing system which includes the following:
  - Joint preparation
  - At least two layers of trowel-grade bituminous coating with interweaved mesh membrane reinforcement
  - Termite-resistant protection board embedded in bituminous coating to prohibit displacement

### **Part 3 - Execution**

- Require that the in-progress installation be observed by the materials manufacturer to ensure that the complete assembly will qualify for the required warranty.
  
- Require that all penetrations be installed in the wall prior to membrane application, so they can be properly sealed by the membrane installer. Avoid the installation of unnecessary sleeves and pay particular attention to the detailing of those that are required.

### **End of Section 07100**

## **DIVISION 7 - THERMAL AND MOISTURE PROTECTION**

### **Section 07200 - Insulation**

#### **Introduction**

This is a section where the consultant should use a "performance specification". Do not specify proprietary manufacturer's names or materials, and do not restrict vendors to a limited list.

This section includes insulation used for thermal purposes, and which is installed as an independent material. Insulation which is an integral of a specific system (e.g. membrane roofing or exterior insulation and finish systems), is described in the appropriate Sections.

Such insulation may be included in the total assembly R-value. However, such insulation must not be the sole source of thermal resistivity for the building.

Design building surfaces which experience a significant temperature differential across their thickness to meet the following thermal resistance ("aged R-value") criteria:

R-19 at walls

R-30 at roofs and exposed floors

Do not specify any form of insulation to be laid directly on accessible ceilings. Instead, detail horizontal insulation at the top of the cavity, and extend vertical insulation up to that level.

#### **Part 1 - General**

- Replace all insulation that becomes wet.

#### **Part 2 - Products**

- Expressly prohibit the use of asbestos-containing materials.
- Specify only molded or extruded polystyrene board, or fiberglass batt, insulation.
- Require fiberglass insulation to have an integral kraft paper or foil vapor barrier.
- Use blown-in insulations only in remodeling projects where the wall or ceiling/roof assembly is inaccessible for installation of board or blanket materials, and only with specific permission of the Project Coordinator.

#### **Part 3 - Execution**

- Specify mechanical attachment for all insulation. Do not specify insulation to be adhesive applied or installed loose.

#### **End of Section 07200**

## **DIVISION 7 - THERMAL AND MOISTURE PROTECTION**

### **Section 07240 - Exterior Insulation and Finish Systems**

#### **Introduction**

Use only Type PM (mechanically attached) systems. Use Type PB (adhesive applied) systems only with specific permission of the Project Coordinator.

Consider alternative exterior cladding systems in areas where the finish may be subject to physical abuse.

Indicate all required expansion, control, and design joints on the drawings.

#### **Part 1 - General**

- Require that all materials manufacturer(s) and applicator(s) demonstrate 5 years of successful installation of similar systems.
- Require that applicators be approved and licensed by the materials manufacturer. Use an approved applicator system as a test for manufacturer approval.
- Specify a special 5 year guarantee against defects in materials and installation; including attachment failure, delamination, cracking, peeling, and fading.
- Require mock-up.

#### **Part 2 - Products**

- Require that all materials be supplied by a single manufacturer, or approved by the primary materials manufacturer, to ensure single-point responsibility for the installation and warranty.
- Specify only extruded polystyrene insulation board, with Class A flame spread and smoke developed characteristics.
- Specify only acrylic-modified Portland cement adhesive and base coat.
- When required, specify only 100% acrylic, integrally colored finish coat, without the need for additional pigmented coatings.
- Where the system will be exposed to potential physical abuse, specify only manufacturers standard "high impact" components.
- Show control joint and expansion joint locations or require submittal of same.

#### **Part 3 - Execution**

- Specifically require the system to be installed in accordance with the manufacturer's recommendations.
- Require the applicators to maintain a "wet edge" until a natural break point is achieved. Expressly prohibit scaffold lines and cold joints.

#### **End of Section 07240**



## **DIVISION 7 - THERMAL AND MOISTURE PROTECTION**

### **Section 07250 - Fireproofing**

#### **Introduction**

Indicate on the drawings the UL Listing Number and fire resistance rating which is required for each condition of structural fireproofing.

Fireproofing systems which are part of a renovation project (e.g. repair of damaged or missing systems, or removal and replacement of existing systems) should follow these standards. Existing fire resistance ratings must not be compromised. The consultant must prepare a complete specification and details for the required repair work. Generic "repair fireproofing as required" notes are not acceptable.

This is a section where the Consultant should use a "performance specification". Do not specify proprietary manufacturer's names or materials, and do not restrict vendors to a limited list.

#### **Part 1 - General**

- Require that all materials manufacturer(s) and applicator(s) demonstrate 5 years of successful installation of similar materials.
- Require submittal of manufacturer's literature describing all materials, and the specific systems to be applied for this project.

#### **Part 2 - Products**

- Specifically prohibit the use of asbestos containing materials.
- When re-fireproofing structural elements where asbestos-containing fireproofing has been abated by the University, specify only materials which are known to be compatible with asbestos encapsulants.

#### **Part 3 - Execution**

- Describe requirements for protection of completed fireproofing.
- Describe specific requirements for repair of fireproofing in the event of damage.
- When re-fireproofing structural elements where asbestos-containing fireproofing has been spot-abated by the University, specifically describe precautions which the Contractor must take to protect adjoining asbestos-containing fireproofing which remains.

#### **End of Section 07250**

## **DIVISION 7 - THERMAL AND MOISTURE PROTECTION**

### **Section 07270 - Firestopping**

#### **Introduction**

Describe in this Section all requirements for firestopping wall penetrations, floor penetrations, ceiling penetrations, and joints. Do not rely on general references in the sealants section. This includes boards, blankets, modules, pillows, tapes, caulks, foams, intumescent, and other similar materials.

Specifically describe on the drawings all requirements for installation of firestopping. Generic notes such as "firestopping as required" are not acceptable. Reliance on the Contractor understanding the building code and "complying at no additional cost" is similarly not acceptable.

This is a section where the Consultant should use a "performance specification". Do not specify proprietary manufacturer's names or materials, and do not restrict vendors to a limited list.

#### **Part 1 - General**

- Require that materials manufacturer(s) and installer(s) demonstrate 5 years of successful installations of similar materials.
- Require submittal of complete manufacturer's literature, including UL test results for each material-and-application system required for the project.
- It is desirable to have all trades use the same product.

#### **Part 2 - Products**

- Specify each type of firestopping material required in the project.
- Product shall be trowable and paintable.

#### **Part 3 - Execution**

- Provide a schedule identifying location and type of firestopping.
- Require installation of sleeves at all wall, floor, and ceiling penetrations.
- Specifically require firestopping materials to be installed in accordance with the manufacturer's recommendations.
- Specifically require that all firestopping be observed as complete prior to being covered by other work.

#### **End of Section 07270**

## **DIVISION 7 - THERMAL AND MOISTURE PROTECTION**

### **Section 07310 - Shingles**

#### **Introduction**

Systems described in this Section are intended to be installed in situations where the roof slope is at least 4 inches per foot, and where the roofs are not intended to receive regular foot traffic for equipment maintenance.

Specify a complete roofing system, making the materials manufacturer responsible for the roofing and flashing system. Require the materials manufacturer to make periodic inspections of the work in progress to ensure that the completed work will qualify for the required warranties.

Do not use roof deck insulation as the only element in the overall building thermal resistance system. Refer to Section 07200.

This is a section where the consultant should use a "performance specification". Do not specify proprietary manufacturer's names or materials, and do not restrict vendors to a limited list.

Shingle roof repairs and modifications which are part of a renovation project (e.g. installation of a new exhaust fan) should follow these standards as much as possible. Existing roof warranties must not be compromised. The consultant must prepare a complete specification and details for the required repair work. Generic "flashing as required" notes (which often appear on engineering details for new exhaust fans) are not acceptable.

Be sure to coordinate specification requirements with roofing, flashing, and parapet wall details.

#### **Part 1 - General**

- Require that materials manufacturer(s) and installer(s) demonstrate 5 years of successful installations of similar systems.
- Require submittal of manufacturer's literature describing the system, and samples of proposed shingles.
- Require a pre-installation conference, scheduled after the substrates are complete, and including the Contractor, Architect, Owner, materials manufacturer, and installing subcontractor(s).
- Shingle roofing is a finish material, not a staging platform for further construction work. Include the following provisions:
  - Require the Contractor to install a "temporary roof" if he desires to "dry-in" the building to allow interior construction to begin or to provide a platform for further exterior construction
  - Describe this requirement as a "Contractor's Option", that is, if he wants to dry-in, he must do so only with a temporary roof
  - Reference the National Roofing Contractor's Association (NRCA) requirements for temporary roofs, including "sacrificial" insulation on metal decks
  - Specifically prohibit "phased roofing"
  - Require that finished roofs be protected with plywood sheets for any and all construction traffic, and that all equipment moving be accomplished with rollers
- Specify expanded warranties as follows:
  - 5 year warranty from the installer covering defects in installation
  - 30 year warranty from the materials manufacturer including defects in materials and installation, and guaranteeing to maintain the system in a waterproof condition for the life of the warranty
  - Full replacement value without proration

- Include all components of the roof assembly, from the deck up
- Include sealing of all perimeters, joints, and penetrations
- Both furnished on the University's special warranty form

### **Part 2 - Products**

- Expressly prohibit the use of asbestos-containing materials.
- Require that all primary and secondary materials be supplied by a single manufacturer, or approved by the primary materials manufacturer, to ensure single-point responsibility for the installation and warranty.
- Specify a manufacturer's standard shingle roofing system as follows:
  - UL Class A fire rating
  - UL Class 90 wind uplift rating
  - Minimum 15-lb asphalt saturated underlayment
  - 30 year fiberglass-reinforced asphalt shingles
- Limit roof insulation to 2" thick. Specify insulations which provide adequate load-bearing capacity at the 2" thickness.

### **Part 3 - Execution**

- Specifically require the roof to be installed in accordance with the manufacturer's recommendations.
- Refer to and describe the appropriate SMCNA details for each edge and penetration condition.
- Require the roofing installer to receive, accept, and install, all sheet metal flashings.
- Specifically prohibit:
  - Pitch pans
  - Guy wires fastened directly to the deck
- Specify (or detail) 3/4" plywood nailers at all parapet walls.
- Require a spray test after completion of the roofing system, to be witnessed by the Contractor, Architect, Owner, materials manufacturer, and installing contractor(s).

### **End of Section 07310**

## **DIVISION 7 - THERMAL AND MOISTURE PROTECTION**

### **Section 07320 - Clay Tile Roofing**

#### **Introduction**

Systems described in this Section are intended to be installed in situations where the roof slope is at least 4 inches per foot, and where the roofs are not intended to receive regular foot traffic for equipment maintenance.

Specify a complete roofing system, making the materials manufacturer responsible for the roofing and flashing system. Require the materials manufacturer to make periodic inspections of the work in progress to ensure that the completed work will qualify for the required warranties.

Do not use roof deck insulation as the only element in the overall building thermal resistance system. Refer to Section 07200.

This is a section where the consultant should use a "performance specification". Do not specify proprietary manufacturer's names or materials, and do not restrict vendors to a limited list.

Clay tile roof repairs and modifications which are part of a renovation project (e.g. installation of a new exhaust fan) should follow these standards as much as possible. Existing roof warranties must not be compromised. The consultant must prepare a complete specification and details for the required repair work. Generic "flashing as required" notes (which often appear on engineering details for new exhaust fans) are not acceptable.

Be sure to coordinate specification requirements with roofing, flashing, and parapet wall details.

#### **Part 1 - General**

- Require that materials manufacturer(s) and installer(s) demonstrate 5 years of successful installations of similar systems.
- Require submittal of manufacturer's literature describing the system, and samples of proposed clay tile.
- Require a pre-installation conference, scheduled after the substrates are complete, and including the Contractor, Architect, Owner, materials manufacturer, and installing subcontractor(s).
- Clay tile roofing is a finish material, not a staging platform for further construction work. Include the following provisions:
  - Require the Contractor to install a "temporary roof" if he desires to "dry-in" the building to allow interior construction to begin or to provide a platform for further exterior construction
  - Describe this requirement as a "Contractor's Option", that is, if he wants to dry-in, he must do so only with a temporary roof
  - Reference the National Roofing Contractor's Association (NRCA) requirements for temporary roofs, including "sacrificial" insulation on metal decks
  - Specifically prohibit "phased roofing"
  - Specifically prohibit all traffic from the finished roof
- Specify expanded warranties as follows:
  - 5 year warranty from the installer covering defects in installation
  - 10 year warranty from the materials manufacturer including defects in materials and installation, and guaranteeing to maintain the system in a waterproof condition for the life of the warranty
  - Renewal option for an additional 10 years from the materials manufacturer
  - Full replacement value without proration
  - Include all components of the roof assembly, from the deck up

- Include sealing of all perimeters, joints, and penetrations
- Both furnished on the University's special warranty form

### **Part 2 - Products**

- Require that all primary and secondary materials be supplied by a single manufacturer, or approved by the primary materials manufacturer, to ensure single-point responsibility for the installation and warranty.
- Specify a manufacturer's standard clay tile roofing system as follows:
  - UL Class A fire rating
  - UL Class 90 wind uplift rating
  - Minimum 30-lb asphalt saturated underlayment
  - Barrel or tapered clay mission tile, closely approximating the existing University context in both color and form.
- Limit roof insulation to 2" thick. Specify insulations which provide adequate load-bearing capacity at the 2" thickness.

### **Part 3 - Execution**

- Specifically require the roof to be installed in accordance with the manufacturer's recommendations.
- Specify only galvanized wire-tied tile installation.
- Refer to and describe the appropriate SMCNA details for each edge and penetration condition.
- Require the roofing installer to receive, accept, and install, all sheet metal flashings.
- Specifically prohibit:
  - Pitch pans
  - Guy wires fastened directly to the deck
- Specify (or detail) 3/4" plywood nailers at all parapet walls.
- Require a spray test after completion of the roofing system, to be witnessed by the Contractor, Architect, Owner, materials manufacturer, and installing contractor(s).

### **End of Section 07320**

## **DIVISION 7 - THERMAL AND MOISTURE PROTECTION**

### **Section 07410 - Preformed Roof and Wall Panels**

#### **Introduction**

Systems described in this Section are intended to be installed in situations where the roof slope is at least 2-1/2 inches per foot, and where the roofs are not intended to receive regular foot traffic for equipment maintenance.

Specify a complete roofing system, making the materials manufacturer responsible for the roofing and flashing system. Require the materials manufacturer to make periodic inspections of the work in progress to ensure that the completed work will qualify for the required warranties.

Do not use roof deck insulation as the only element in the overall building thermal resistance system. Refer to Section 07200.

This is a section where the consultant should use a "performance specification". Do not specify proprietary manufacturer's names or materials, and do not restrict vendors to a limited list.

Metal roof repairs and modifications which are part of a renovation project (e.g. installation of a new exhaust fan) should follow these standards as much as possible. Existing roof warranties must not be compromised. The consultant must prepare a complete specification and details for the required repair work. Generic "flashing as required" notes (which often appear on engineering details for new exhaust fans) are not acceptable.

Be sure to coordinate specification requirements with roofing, flashing, and parapet wall details.

#### **Part 1 - General**

- Require that materials manufacturer(s) and installer(s) demonstrate 5 years of successful installations of similar systems.
- Require submittal of:
  - Manufacturer's literature describing the system
  - Shop drawings showing panel layout, and all edge, transition, and penetration details
  - Samples of proposed metal panels
- Require a pre-installation conference, scheduled after the substrates are complete, and including the Contractor, Architect, Owner, materials manufacturer, and installing subcontractor(s).
- Metal roofing is a finish material, not a staging platform for further construction work. Include the following provisions:
  - Require the Contractor to install a "temporary roof" if he desires to "dry-in" the building to allow interior construction to begin or to provide a platform for further exterior construction
  - Describe this requirement as a "Contractor's Option", that is, if he wants to dry-in, he must do so only with a temporary roof
  - Reference the National Roofing Contractor's Association (NRCA) requirements for temporary roofs, including "sacrificial" insulation on metal decks
  - Specifically prohibit "phased roofing"
  - Specifically prohibit all traffic from the finished roof
- Specify expanded warranties as follows:
  - 5 year warranty from the installer covering defects in installation
  - 30 year warranty from the materials manufacturer including defects in materials and installation, and guaranteeing to maintain the system in a waterproof condition for the life of the warranty

- Full replacement value without proration
- Include all components of the roof assembly, from the deck up
- Include sealing of all perimeters, joints, and penetrations
- Both furnished on the University's special warranty form

## **Part 2 - Products**

- Require that all primary and secondary materials be supplied by a single manufacturer, or approved by the primary materials manufacturer, to ensure single-point responsibility for the installation and warranty.
- Specify a manufacturer's standard preformed metal roofing system as follows:
  - UL Class A fire rating
  - UL Class 90 wind uplift rating
  - Minimum 15-lb asphalt saturated underlayment
  - Factory formed panels, steel, aluminum, or copper
  - Concealed fastener installation
  - Factory applied polyvinylidene fluoride finish, or natural metal finish intended for exposure to the elements
- Limit roof insulation to 2" thick. Specify insulations which provide adequate load-bearing capacity at the 2" thickness.
- Minimum gauges
  - Roofs 22 ga
  - Walls 18 ga
- Minimum panel width 12"

## **Part 3 - Execution**

- Specifically require the roof to be installed in accordance with the manufacturer's recommendations.
- Refer to and describe the appropriate SMCNA details for each edge and penetration condition.
- Require the roofing installer to receive, accept, and install, all sheet metal flashings.
- Specifically prohibit:
  - Pitch pans
  - Guy wires fastened directly to the deck
- Specify (or detail) 3/4" plywood nailers at all parapet walls.
- Require a spray test after completion of the roofing system, to be witnessed by the Contractor, Architect, Owner, materials manufacturer, and installing contractor(s).

## **End of Section 07410**



## **DIVISION 7 - THERMAL AND MOISTURE PROTECTION**

### **Section 07500 - Membrane Roofing**

#### **Introduction**

Systems described under this Section are not intended to receive regular foot traffic. Occasional traffic for maintenance of equipment is acceptable.

Where horizontal surfaces enclosing habited spaces are intended to be regularly occupied or otherwise used for the building occupants' activities, refer to the requirements of Section 07590 Horizontal Traffic Surfacing.

Specify a complete roofing system, making the materials manufacturer responsible for the roofing and flashing system. Require the materials manufacturer to make periodic inspections of the work in progress to ensure that the completed work will qualify for the required warranties.

The University uses a built-up SBS-modified bitumen roofing system, applied either hot mopped, self adhered or cold emulsion, in virtually all conditions. Use of other roofing systems must receive specific permission from the Project Manager.

Gravel surface roofs shall NOT be specified.

Torch-applied materials of any kind shall NOT be specified.

Single-ply roofs shall NOT be specified.

Asbestos-containing materials shall NOT be specified.

Do not use roof deck insulation as the only element in the overall building thermal resistance system. Refer to Section 07200.

This is a section where the consultant should use a "performance specification". Do not specify proprietary manufacturer's names or materials, and do not restrict vendors to a limited list.

Membrane roof repairs and modifications which are part of a renovation project (e.g. installation of a new exhaust fan) should follow these standards as much as possible. Existing roof warranties must not be compromised. The consultant must prepare a complete specification and details for the required repair work. Generic "flashing as required" notes (which often appear on engineering details for new exhaust fans) are not acceptable.

Be sure to coordinate specification requirements with roofing, flashing, and parapet wall details.

#### **Part 1 - General**

- Require that materials manufacturer(s) and installer(s) demonstrate 5 years of successful installations of similar systems.
- Require submittal of manufacturer's literature describing the system, and samples of proposed membrane materials.
- Require a pre-installation conference, scheduled after the substrates are complete, and including the Contractor, Architect, Owner, materials manufacturer, and installing subcontractor(s).
- Membrane roofing is a finish material, not a staging platform for further construction work. Include the following provisions:
  - Require the Contractor to install a "temporary roof" if he desires to "dry-in" the building to allow interior construction to begin or to provide a platform for further exterior construction.
  - Describe this requirement as a "Contractor's Option", that is, if he wants to dry-in, he must do so only with a temporary roof.
  - Reference the National Roofing Contractor's Association (NRCA) requirements for temporary roofs, including "sacrificial" insulation on metal decks.
  - Specifically prohibit "phased roofing".
  - Specifically prohibit patches in the finished roof.

- Require that finished roofs be protected with plywood sheets for any and all construction traffic, and that all equipment moving be accomplished with rollers.
- Specify expanded warranties as follows:
  - 5 year warranty from the installer covering defects in installation.
  - 10 year warranty from the materials manufacturer including defects in materials and installation, and guaranteeing to maintain the system in a waterproof condition for the life of the warranty.
  - Renewal option for an additional 10 years from the materials manufacturer.
  - Full replacement value without proration.
  - Include all components of the roof assembly, from the deck up.
  - Include sealing of all perimeters, joints, and penetrations.
  - Both warranties shall be furnished on the University's special warranty form.
- Calculate insulation thickness to allow for 8" minimum clearance for all roof penetrations, doors, curbs, windows, etc.

## **Part 2 - Products**

- Require that all primary and secondary materials be supplied by a single manufacturer, or approved by the primary materials manufacturer, to ensure single-point responsibility for the installation and warranty.
- Specify a manufacturer's standard built-up roofing system as follows:
  - UL Class A fire rating.
  - UL Class 90 wind uplift rating.
  - 3-ply SBS-modified bitumen system. (Base sheet + 2 ply sheets)
  - Mineral surface cap sheet (4<sup>th</sup> ply)
  - Applied with either hot asphalt mop, self adhered or cold emulsion.
- Limit roof insulation to 2" thick. Specify insulations which provide adequate load-bearing capacity at the 2" thickness.

## **Part 3 - Execution**

- Specifically require the roof to be installed in accordance with the manufacturer's recommendations.
- Refer to and describe the appropriate SMCNA details for each edge and penetration condition. Require the roofing installer to receive, accept, and install, all sheet metal flashings.
- Specifically prohibit:
  - Pitch pans.
  - Guy wires fastened directly to the deck.
- Specify (or detail) 3/4" plywood nailers at all parapet walls.
- Require a spray test after completion of the roofing system, to be witnessed by the Contractor, Architect, Owner, materials manufacturer, and installing contractor(s). Do not require a flood test.

## **End of Section 07500**

## **DIVISION 7 - THERMAL AND MOISTURE PROTECTION**

### **Section 07570 - Traffic Topping**

#### **Introduction**

Systems described under this Section are intended to be installed on exterior walking surfaces which do not enclose habited space.

Where horizontal surfaces enclosing habited spaces are intended to be regularly occupied or otherwise used for the building occupants' activities, refer to the requirements of Section 07590 Horizontal Traffic Surfacing.

Specify a complete traffic topping system, making the materials manufacturer responsible for the roofing and flashing system. Require the materials manufacturer to make periodic inspections of the work in progress to ensure that the completed work will qualify for the required warranties.

This is a section where the consultant should use a "performance specification". Do not specify proprietary manufacturer's names or materials, and do not restrict vendors to a limited list.

Traffic topping repairs and modifications which are part of a renovation project should follow these standards as much as possible. Existing warranties must not be compromised. The consultant must prepare a complete specification and details for the required repair work. Generic "flashing as required" notes are not acceptable.

Be sure to coordinate specification requirements with traffic topping, flashing, and parapet wall details.

#### **Part 1 - General**

- Require that materials manufacturer(s) and installer(s) demonstrate 5 years of successful installations of similar systems.
- Require submittal of manufacturer's literature describing the system, and samples of proposed membrane materials.
- Require a pre-installation conference, scheduled after the substrates are complete, and including the Contractor, Architect, Owner, materials manufacturer, and installing subcontractor(s).
- Traffic topping is a finish material, not a staging platform for further construction work. Include the following provisions:
  - Specifically prohibit "phased installation" of traffic topping
  - Specifically prohibit patches in the finished membrane
  - Require that finished decks be protected with plywood sheets for any and all construction traffic, and that all equipment moving be accomplished with rollers
- Specify expanded warranties as follows:
  - 5 year warranty from the installer covering defects in installation
  - 10 year warranty from the materials manufacturer including defects in materials and installation, and guaranteeing to maintain the system in a waterproof condition for the life of the warranty
  - Renewal option for an additional 10 years from the materials manufacturer
  - Full replacement value without proration
  - Include all components of the traffic topping assembly, from the deck up
  - Include sealing of all perimeters, joints, and penetrations
  - Both furnished on the University's special warranty form

## Part 2 - Products

- Expressly prohibit the use of asbestos-containing materials.
- Require that all primary and secondary materials be supplied by a single manufacturer, or approved by the primary materials manufacturer, to ensure single-point responsibility for the installation and warranty.
- Specify a manufacturer's standard traffic topping system as follows:
  - UL Class A fire rating
  - Manufacturer's proprietary primer
  - Fully-adhered, fabric-reinforced, rubberized urethane waterproof membrane
  - Elastomeric polyurethane wear surface, with integral color and slip-resistant finish
  - Minimum system thickness 225 mils
  - Integral cove flashing

## Part 3 - Execution

- Specifically require the traffic topping to be installed in accordance with the manufacturer's recommendations.
- Refer to and describe the appropriate SMCNA details for each edge and penetration condition.
- Require the traffic topping installer to receive, accept, and install, all sheet metal flashings.
- Specifically prohibit:
  - Pitch pans
  - Guy wires fastened directly to the deck
- Specify (or detail) 3/4" plywood nailers at all parapet walls.
- Require a spray test after completion of the roofing system, to be witnessed by the Contractor, Architect, Owner, materials manufacturer, and installing contractor(s).

**End of Section 07570**

## **DIVISION 7 - THERMAL AND MOISTURE PROTECTION**

### **Section 07590 - Horizontal Traffic Surfacing**

#### **Introduction**

Systems described under this Section are intended to be installed on exterior walking surfaces which enclose habited space.

Where horizontal surfaces which do not enclose habited spaces are intended to be regularly occupied or otherwise used for the building occupants' activities, refer to the requirements of Section 07570 Traffic Topping.

Specify a complete horizontal traffic surfacing system, making the materials manufacturer responsible for the surfacing and flashing system. Require the materials manufacturer to make periodic inspections of the work in progress to ensure that the completed work will qualify for the required warranties.

Do not use traffic deck insulation as the only element in the overall building thermal resistance system. Refer to Section 07200.

This is a section where the consultant should use a "performance specification". Do not specify proprietary manufacturer's names or materials, and do not restrict vendors to a limited list.

Horizontal traffic surfacing repairs and modifications which are part of a renovation project should follow these standards as much as possible. Existing warranties must not be compromised. The consultant must prepare a complete specification and details for the required repair work. Generic "flashing as required" notes are not acceptable.

Be sure to coordinate specification requirements with traffic surfacing, flashing, and wall details.

#### **Part 1 - General**

- Require that materials manufacturer(s) and installer(s) demonstrate 5 years of successful installations of similar systems.
- Require submittal of:
  - Manufacturer's literature describing the system
  - Samples of proposed membrane materials
  - Samples of the proposed pavers
- Require a pre-installation conference, scheduled after the substrates are complete, and including the Contractor, Architect, Owner, materials manufacturer, and installing subcontractor(s).
- Horizontal traffic surfacing is a finish material, not a staging platform for further construction work. Include the following provisions:
  - Require the Contractor to install a "temporary roof" if he desires to "dry-in" the building to allow interior construction to begin or to provide a platform for further exterior construction
  - Describe this requirement as a "Contractor's Option", that is, if he wants to dry-in, he must do so only with a temporary roof
  - Reference the National Roofing Contractor's Association (NRCA) requirements for temporary roofs, including "sacrificial" insulation on metal decks
  - Specifically prohibit "phased" traffic surfacing installation
  - Specifically prohibit patches in the finished membrane
  - Require that finished systems be protected with plywood sheets for any and all construction traffic, and

that all equipment moving be accomplished with rollers

- Specify expanded warranties as follows:
  - 5 year warranty from the installer covering defects in installation
  - 10 year warranty from the materials manufacturer including defects in materials and installation, and guaranteeing to maintain the system in a waterproof condition for the life of the warranty
  - Renewal option for an additional 10 years from the materials manufacturer
  - Full replacement value without proration
  - Include all components of the traffic surfacing assembly, from the deck up, including removal and reinstallation of the pavers
  - Include sealing of all perimeters, joints, and penetrations
  - Both furnished on the University's special warranty form

## Part 2 - Products

- Expressly prohibit the use of asbestos-containing materials.
- Require that all primary and secondary materials be supplied by a single manufacturer, or approved by the primary materials manufacturer, to ensure single-point responsibility for the installation and warranty.
- Specify a manufacturer's standard horizontal traffic surfacing system as follows:
  - UL Class A fire rating
  - Fabric-reinforced fully-adhered, rubberized asphalt membrane, 225 mils minimum thickness
  - Integral cove flashing
  - Manufacturer's proprietary protection sheet
  - Manufacturer's proprietary drainage sheet
  - 1" thick, cfc-free, extruded polystyrene foam insulation, approved by horizontal traffic surfacing system manufacturer
  - Precast concrete pavers
    - *Special attention shall be given so as to ensure that concrete pavers provide appropriate slip resistance. Stained, coated or painted pavers are expressly prohibited.*

## Part 3 - Execution

- Specifically require the horizontal traffic surfacing to be installed in accordance with the manufacturer's recommendations.
- Refer to and describe the appropriate SMCNA details for each edge and penetration conditions.
- Require the traffic surfacing installer to receive, accept, and install, all sheet metal flashings.
- Specifically prohibit:
  - Pitch pans
  - Guy wires fastened directly to the deck
- Specify (or detail) 3/4" plywood nailers at all parapet walls.
- Require a spray test after completion of the roofing system, to be witnessed by the Contractor, Architect, Owner, materials manufacturer, and installing contractor(s).

## End of Section 07570

## **DIVISION 7 - THERMAL AND MOISTURE PROTECTION**

### **Section 07600 - Flashing and Sheet Metal**

#### **Introduction**

Wherever possible, describe flashing systems which use concealed fasteners, clips, and cleats. Where exposed fasteners are unavoidable, specifically describe a fastening system which absolutely prohibits entrance of water, and which will remain watertight for the life of the facility.

Wherever possible, avoid reliance on sealants as the sole means of prohibiting entrance of water.

Use matching materials on renovations of existing buildings which contain copper flashing materials.

Describe all requirements for installation of sheet metal work which is associated with the roofing system and its special warranties in the appropriate roofing section, to maintain single-point responsibility for the roof warranty.

Describe all requirements for sealants in Section 07900.

Specifically detail all conditions on the drawings, including references to specific requirements of the Sheet Metal and Air Conditioning Contractor's National Association (SMACNA) "Architectural Sheet Metal Manual".

#### **Part 1 - General**

- Require submittal of shop drawings and details of each condition and joint.

#### **Part 2 - Products**

- Specify minimum 24 gauge thickness for galvanized metal, and identify specific heavier gauges where the project requires.  
-OR-
- Specify minimum 16 ounce for copper, and identify specific heavier materials where the project requires.
- Use only minimum 16 ounce copper for masonry through-wall, lintel, or other similar embedded flashings.
- Use only 4 pound lead for roof drain sump pans.
- When necessary, use 4 pound lead for flashings involving compound curves or where sheetmetal can not be adequately formed. This application requires a galvanized sheet metal protective cover.
- Where 2-piece reglets are required, describe the specific shape and substrate conditions, but do not reference proprietary manufacturer's products.
- Do not specify roof jacks or boots which utilize integral neoprene seals.
- Use only galvanized structural steel tube or pipe for downspout sections which are subject to impact and abuse.
- Specify only 50/50 tin/lead solder when applicable.
- Specify only non-corrosive fasteners, same material as metal being fastened, with matching finish on exposed heads. Specify neoprene-backed washers for screw fasteners.

- **Part 3 - Execution**

- Specifically describe requirements for expansion and contraction joints, and for sealing joints in running flashings. Do not rely on generic "provide expansion joints as required" notes.
- Specifically design joints to allow for removal and reinstallation of flashings during re-roofing. Two-piece reglets are preferred.
- Specifically describe requirements for separating dissimilar metals.

**End of Section 07600**



## **DIVISION 7 - THERMAL AND MOISTURE PROTECTION**

### **Section 07700 - Roof Specialties and Accessories**

#### **Introduction**

Include all items which become an integral part of the roof moisture protection system in this Section.

In certain limited situations where items are more appropriately described in other sections (e.g. prefabricated mechanical equipment curbs), make specific cross references in both sections, and require the installation of those items to comply with the requirements of the appropriate Division 7 Section(s).

Describe all requirements for installation of roof accessories which are associated with the roofing system and its special warranties in the appropriate roofing section, to maintain single-point responsibility for the roof warranty.

Accessories which require structural support (e.g. antennae) must be supported from the building structure. Do not specify and expressly prohibit attachments through the roof membrane, and guy wires.

Items which must pass through the roof membrane (e.g. antennae cables) must pass through a conduit. Do not specify and expressly prohibit penetrations directly through the membrane, and cables snaked through other penetrations.

Detail and specify burglar bars (6" maximum spacing each way) in all situations where roof deck openings would otherwise allow entry to the building.

#### **Part 1 - General**

- Require submittal of manufacturer's literature, and installation details.

#### **Part 2 - Products**

- Specify only metal accessories. Specifically prohibit use of PVC and other plastics.
- Wherever possible, specify accessories which have integral curbs sufficiently tall to permit secure installation of flashing and counterflashing.
- Where roof accessories are not ordinarily curbed, specify and detail custom fabricated curbs.
- Avoid as much as possible accessory units which rely on flat flanges to permit secure application of roof membrane.

#### **Part 3 - Execution**

- There are no unique University requirements in this Section.

#### **End of Section 07700**

## **DIVISION 7 - THERMAL AND MOISTURE PROTECTION**

### **Section 07800 - Skylights**

#### **Introduction**

Avoid use of skylights wherever possible. Clerestories and light monitors are superior solutions. Use skylights, clerestories, and monitors only with specific permission of the Project Manager.

Existing skylights which are part of a renovation project should always be considered for removal or replacement with alternative light gathering elements. Specifically discuss such situations with the Project Manager.

Describe all requirements for flashing and sealing of skylights in the appropriate roofing section, to maintain single-point responsibility for the roof warranty.

Skylights which require structural support must be supported from the building structure. Do not specify and expressly prohibit attachments through the roof membrane.

Detail and specify burglar bars (6" maximum spacing each way) in all situations where roof deck openings would otherwise allow entry to the building.

#### **Part 1 - General**

- Require submittal of manufacturer's literature, and installation details.

#### **Part 2 - Products**

- Specify only double-domed, solar-glazed, steel or aluminum-framed skylights.
- Wherever possible, specify skylights which have integral curbs sufficiently tall to permit secure installation of flashing and counterflashing.
- Where the required skylight roof is not integrally curbed, specify and detail custom fabricated curbs.
- Do not use skylights which rely on flat flanges to permit secure application of roof membrane.

#### **Part 3 - Execution**

- There are no unique University requirements in this Section.

#### **End of Section 07800**

## **DIVISION 7 -THERMAL AND MOISTURE PROTECTION**

### **Section 07900 - Sealants**

#### **Introduction**

Describe all requirements for installation of sealants required to prohibit the penetration of moisture and dust, and required to seal joints between dissimilar materials, in this Section.

Specify certain specialized sealants which are ordinarily part of a "complete in place" installation by a particular trade (e.g. glazing sealants and painting) in the appropriate sections.

Reliance on caulking which might (or might not) be provided by a painter as part of that finish operation, as the moisture- or dust-seal, is unacceptable.

Pay particular attention in sealant system design to expected joint movement, joint dimensions, sealant position (horizontal, vertical, or overhanging), and potential for physical abuse of the sealed joint.

Specifically describe and detail on the drawings all joints requiring installation of sealants. Generic notes such as "sealant as required" are not acceptable.

This is a section where the Consultant should use a "performance specification". Do not specify proprietary manufacturer's names or materials, and do not restrict vendors to a limited list.

#### **Part 1 - General**

- Require that all materials manufacturer(s) and installer(s) demonstrate 5 years of successful installations of similar materials.
- Require submittal of the following:
  - Manufacturer's literature documenting compliance with specification requirements
  - Actual sealant samples for color selection
  - Sample joints, where unique conditions require
- Maximum allowable exterior joint width, for caulking/sealant, shall not exceed 1".

#### **Part 2 - Products**

- Specify each particular type of sealant and sealant system required, including:
  - Primers
  - Backers
  - Fillers
  - Colors
- Expressly prohibit the use of latex and butyl sealants.
- Specify only non-staining materials.

#### **Part 3 - Execution**

- Provide a sealant schedule identifying location and type of sealant.
- Specifically require sealants to be installed in accordance with the manufacturer's recommendations.
- Specifically require all joints to be observed by the Owner prior to installation of sealants.

#### **End of Section 07900**

## **DIVISION 8 - DOORS AND WINDOWS**

### **Section 08000 - General Discussion**

#### **Introduction**

This General Discussion Section contains material which is critical to successful door and window installations, in new construction and renovation, but which is not the sole responsibility of any individual trade. In many cases, the issues involved are fundamental to the basic design of the project, and the success or failure of this element of the project is determined at the very outset of the design process.

The Consultant is expressly responsible for incorporating these overall requirements into the project, and for ensuring that all subconsultants are aware of the requirements and incorporate them into their designs as well.

Reliance on "after-the-fact" material selections to compensate for a problematic design decision is unacceptable.

*The use of wired fire rated safety glass has been determined an undesirable safety risk and is no longer allowed. Consequently glazed openings in fire rated doors and windows will require the use of fire rated glass.*

#### **Major Entrances**

Generally, major building entrances will utilize some sort of monumental storefront system. All other exterior doors and frames should be steel.

#### **Multiple Doors, Pairs of Doors, Banks of Doors**

Exit widths in excess of 3'-0" are often required in major facilities. In such instances, the University prefers to use banks of single leaf doors, rather than double doors with center mullions. This requirement includes the following situations:

- major building entrances
- assembly occupancy entrance/exits (both interior and exterior)

In such situations which also require large widths for passage of equipment, use wider door leaves.

Preferably, use overhead doors as the primary means for passage of equipment.

Since the University does not use vertical rod exit devices, pairs of doors will necessarily have center mullions. In situations where use of center mullions is unavoidable and which also require large widths, the mullions must be removable. Specify these mullions in Section 08710 - Hardware.

Do not specify center mullions for double-egress doors in corridors.

#### **Large Interior Doors**

Where interior spaces require large doors for the passage of equipment (e.g. general laboratories, shared equipment laboratories, etc.), specify 3'-6" or 4'-0" single leaf doors (with appropriate adjustments in frame gauge and hardware requirements) rather than pairs of 3'-0" + 1'-0" doors.

#### **Coordination and Preparation**

Make specific references to ensure that requirements for coordination of doors, frames, and hardware, is clearly included in the Contractor's scope of work. This often involves the steel door and frame supplier, the wood door supplier, the hardware supplier, and the installers of these materials. While this type of coordination is implicit in the Contractor's scope, a specific reference provides an additional level of comfort.

A common example of the lack of this coordination is an interior wood door in a steel frame with a smoke gasket. If even one of the trades involved fails to properly coordinate, it is likely the door will not close and latch properly against the gasket.

The Consultant should also ensure during submittal review that such issues are clearly identified in the submittals of all the trades involved.

**End of Section 08000**

## **DIVISION 8 - DOORS AND WINDOWS**

### **Section 08110 - Steel Doors and Frames**

#### **Introduction**

This is a section where the consultant should use a "performance specification". Do not specify proprietary manufacturer's names or materials, and do not restrict vendors to a limited list.

Do not specify knock-down or so-called "drywall" metal door frames.

#### **Part 1 - General**

- Require that all steel doors and frames comply with the requirements of:
  - National Association of Architectural Metal Manufacturers Standard HMMA 861
  - Building Hardware Manufacturer's Association (BHMA)
  - Underwriter's Laboratories (UL) rated and labeled where required
- Require submittal of:
  - manufacturer's literature
  - shop drawings
  - Complete door and frame schedule covering every opening

#### **Part 2 - Products**

- Specify doors and frames in the following gauges:
  - exterior frames: 14 gauge
  - interior frames > 4'-0": 14 gauge
  - interior frames < 4'-0": 16 gauge
  - doors: 18 gauge
- Specify doors and frames with factory-applied primer, ready for field finishing.
- Specify and detail door frames with:
  - fully mitered, welded, and ground corners
  - double rabbeted profiles, with equal-sized rabbets
  - 2" rails and head, and always equal-size
  - exterior sidelights and transoms for interior glazing only
  - lights which extend to the floor with 4" bottom rails
  - mortar boxes for all hardware
  - ASA strikes for full mortise locks
  - 4 wall anchors plus 1 floor anchor per jamb
    - corrugated 14 gauge T-type for masonry walls
    - welded to frame for stud walls
    - use dimpled anchors only for openings in existing walls.
  - silencers on all frames
- Specify and detail doors with:

- seamless faces
  - edge seams welded and ground
  - rigid polystyrene core fully bonded to the steel face sheets
  - closed watertight top
  - inverted bottom closure channel
  - minimum 6" head rail, 6" stiles, and 12" bottom rail, at all lights and louvers
  - provide pockets for full mortise lock
- Specifically require that doors and frames be prepared and internally reinforced at the factory for installation of butts, closers, locksets, exit devices, and all other scheduled hardware. Specifically prohibit field preparation of steel doors and frames.
  - Make specific reference that the rabbet of door frames be sized, and that factory preparation for butts in both doors and frames must make allowance, for silencers or smoke gaskets.

### **Part 3 - Execution**

- Specifically require that all doors and frames be installed in conformance with HMMA, BHMA, and UL requirements.
- Require that all doors be completely hung, with all hardware installed, tested, and adjusted for perfect fit, prior to field finishing. Require that doors be dismantled and hardware removed, and re-hung after finishing is complete.

### **End of Section 08110**

## **DIVISION 8 - DOORS AND WINDOWS**

### **Section 08210 - Wood Doors**

#### **Introduction**

This is a section where the consultant should use a "performance specification". Do not specify doors by proprietary manufacturer's names or model numbers, and do not restrict vendors to a limited list.

Do not specify wood doors for exterior applications.

#### **Part 1 - General**

- Reference the following standards as applicable and coordinate specifications to comply without conflicts.
  - Architectural Woodwork Institute (AWI) Quality Standards, Section 1300 Architectural Flush Doors, current edition.
  - Window & Door Manufacturers Association (WDMA), ANSI/WDMA I.S 1-A-97 Wood Flush Doors
  - NFPA 80 – Fire Doors and Windows
  - NFPA 252 – Fire Test for Door Assemblies
  - ASTM E152 – Fire Tests of Door Assemblies
  - UL 10B – Fire Tests of Door Assemblies
- Require these associations' stamps and labels to be affixed to the doors.
- Require submittal of manufacturer's literature, and 6"x6" corner samples.
- Require doors to be wrapped in plastic. Individual cartoning is not required.
- Specify full lifetime guarantee for interior wood doors. Include defective materials and fabrication, delamination, warping, telegraphing. Include replacement, reinstallation, and refinishing of the door.

#### **Part 2 - Products**

- Specify only 1-3/4" thick solid core doors for all interior applications.
- Specify doors complying with AWI "premium grade", PC7 ME or PC5 ME with select white birch veneer faces, rotary cut, book matched grain, balance matched assembly, for transparent finish. For new buildings, alternative veneers require project manager approval.
- Specify particle board cores, with stiles and rails glued to core and sanded before laminating, for general non-rated applications, and for 20-minute fire-rated applications.
- Specify mineral cores of appropriate ratings, with stiles and rails glued to core and sanded before laminating, where 3/4-hour or longer fire-rated doors are required.
- Require solid wood blocks in fire-rated doors as support for installation of mortise and/or cylinder type locksets (2-3/4" backset), and of closers.
- Require rails and stiles of solid hardwood (not laminated or veneered), 1-1/8" minimum for rails, 1-3/8" minimum for stiles.
- Require surrounds for lite and louver openings for non-rated doors of solid hardwood (not laminated or veneered), 6" minimum.
- Specify glazing stops of same hardwood as door facing.



- Require rated metal surrounds and glazing for lites at rated doors. Require profile of rated surround to match profile of specified wood surrounds of non-rated doors.
- Specify pair matched, set matched and continuous matched transoms, where applicable.
- Specify only Type I adhesives for all applications.
- Specify minimum STC 35 sound rating for single leaf doors for most applications. Discuss requirements for higher STC ratings with the Project Manager.

### **Part 3 - Execution**

- Specify installation using the following criteria:
  - bevel doors on 3 sides.
  - trim doors to provide 1/8" reveal on 3 sides.
  - if beveling or trimming is required, seal all surfaces to prevent swelling.
  - machine, trim, and mount doors to receive all specified items of hardware (especially smoke gaskets and weatherstrips), and to latch without binding.

**End of Section 08210**

## **DIVISION 8 - DOORS AND WINDOWS**

### **Section 08305 - Access Doors**

#### **Introduction**

Provide access doors to attics, roofs, crawl spaces, tunnels, elevator equipment rooms, overhead areas, mechanical equipment rooms, and similar spaces where University personnel must have access for maintenance or repair.

All access doors shall be specified in this section. Coordinate with work in other divisions (i.e., electrical and mechanical). On architectural drawings show all access doors on ceiling plans and on wall elevations.

#### **Part 1 - General**

- Minimum size shall be 16" x 16" for walls and 24" x 24" for ceilings. Size may be larger if required for replacement of materials/equipment.
- Access doors shall be fire rated where required. Locations should be noted on plans.
- All access doors shall be metal.
- Provide key locks only on doors to elevator equipment areas

#### **Part 2 - Products**

- Access doors shall have continuous hinges and a minimum of two (2) cam type latches..

#### **Part 3 - Execution**

- Access doors shall be painted in the open position.

#### **End of Section 08305**

## **DIVISION 8 - DOORS AND WINDOWS**

### **Section 08330 - Overhead Coiling Doors**

#### **Introduction**

Provide Overhead coiling doors where necessary for service or access. Avoid the use of pairs of swing type doors for service access

Avoid these type doors as part of fire rated wall opening

Avoid the use of security grilles

Where egress is required, provide adjacent (not integral) personnel exit door assembly.

Where an insulated door is required, sectional type shall be provided.

#### **Part 1 - General**

- Use manual push up type except where crank, chain or motor operation is appropriate due to size.

#### **Part 2 - Products**

- Provide cylinder locking method in bottom bars.

#### **Part 3 - Execution**

- Insure that fusible link, if applicable, is accessible on doors used as a fire rated curtain.

#### **End of Section 08330**

## **DIVISION 8 - DOORS AND WINDOWS**

### **Section 08400 - Entrances and Storefronts**

#### **Introduction**

Evaluate if future reglazing can be accomplished easily from the exterior.

#### **Part 1 - General**

- Consultant shall establish the minimum level of quality. System shall be “engineered”.
- Generally, these systems shall not incorporate operable windows.
- System shall accommodate the hardware components specified in Section 08710 - Finish Hardware. Substitutions of manufacturers standard hardware is not permitted.

#### **Part 2 - Products**

- Finishes shall be noted. If anodized or powder coated give class #.
- Determine if window washing hooks are necessary.
- Require design to provide for a simple re-glazing system.
- Specify the framing system. System shall provide positive drainage to the exterior.
- Entrance doors shall be minimum “wide style” type. Equivalent to Kawneer 500 series or approved equal.

#### **Part 3 - Execution**

- There are no unique University requirements.

#### **End of Section 08400**

## **DIVISION 8 - DOORS AND WINDOWS**

### **Section 08500 - Metal Windows**

#### **Introduction**

Finishes, maintenance and heat loss or gain are important considerations. Double glazing is required on all exterior windows.

Operable sash for emergency exit from dormitory rooms to meet code requirements must be considered as well as operable sash in air conditioned buildings where the equipment may fail for some reason.

Institutional quality construction and superior coatings and finishes should be considered if the budget will permit.

Interior glazing is preferred, for glass replacement, above the ground floor level.

#### **Part 1 - General**

- Require test results for water and air infiltration.
- Require certification that window meets requirements of Steel Window Institute or Aluminum Window Institute.
- Detailing shall provide for drainage, weepage, flashing, etc. for a weather tight installation.

#### • **Part 2 - Products**

- Require protective coverings if materials are prefinished.

#### • **Part 3 - Execution**

- There are no unique University requirements.

**End of Section 08500**

## **DIVISION 8 - DOORS AND WINDOWS**

### **Section 08610 - Wood Windows**

#### **Introduction**

Wood windows are to be used only in restoration work on historical buildings.

#### **Part 1 - General**

- There are no unique University requirements.

- **Part 2 - Products**

- There are no unique University requirements.

- **Part 3 - Execution**

- There are no unique University requirements.

**End of Section 08610**

## **DIVISION 8 - DOORS AND WINDOWS**

### **Section 08710 - Finish Hardware**

#### **Introduction**

The University of Arizona has determined that, based on its experience with the performance and durability of the products described in this Section, and based on the benefits of limiting the range of repair parts which must be maintained in inventory, a proprietary specification is in the best interest of the University.

Specify all hardware required for a fully functioning, secure, weatherproof installation for all swinging, sliding, and folding doors.

Include unique door or frame dependent hardware in those sections.

Include cabinet hardware in the appropriate Division 6 section.

In renovation projects, specify hardware which matches the existing hardware type for function, appearance, trim, and finish, except where other overriding considerations such as handicapped accessibility require deviations. The Consultant must determine the existing conditions and specify materials which match those conditions. Requiring the Contractor to "match existing as required" is unacceptable.

In special cases, hardware different from those items described below may be required. In all such cases, secure specific permission of the Project Coordinator. These cases may include:

Alarmed exit devices

Electronic security access

Matching "period" hardware in historic buildings

Include on the drawings a schedule indicating which specific hardware group applies to each individual door. Pay particular attention to identifying the desired function of each door lockset.

#### **Part 1 - General**

- Require submittal of a complete hardware schedule describing each door and each hardware group, including technical data for each item.
- Require that the supplier of finish hardware have as a full-time employee a regular member of the American Society of Hardware Consultants, and that the hardware schedule be prepared by the AHC member.
- Require delivery to the Owner upon Substantial Completion all adjusting tools, keys, dogging keys, and other maintenance materials.

#### **Part 2 - Products**

- Butts
  - Pre-qualified manufacturers are:
    - Hager
    - Lawrence
    - McKinney
    - Stanley
  - Minimum 1-1/2 pair per door
  - Always ball bearing
  - Always non-removable pins
- Closers
  - Use only Rixson 27 floor closer, with top and intermediate pivots, at all public exterior doors.

- Use LCN 4041 or equivalent Sargent at all other applications.
  - Non-handed, adjustable size, 4-way mountable.
  - Cast iron body.
  - Take advantage of available arm options where appropriate for various situations. (Hold open, cushion stop, 180 degree, delayed action, etc.).
  - Require through-bolt installation at wood and metal doors and surface-applied installation at metal door frames. Preferred installation is on the door. If jamb mounting is necessary, all holes to be drilled and tapped.
  - 10 year warranty.
  - All closers must comply with ADA requirements. Closure speed adjusted to 7 seconds.
- Use only wall-mounted hold open devices where doors with closers are intended to be normally open.
- Exit Devices
  - Pre-qualified manufacturers are:
    - Sargent 8800 series
    - Von Duprin 99 series
  - Use the following functions and trim in the noted applications; use no other functions or trim (these designations are based on Sargent products; similar Von Duprin products are acceptable).

• 04	exterior (key)	PTB	entrance doors (with bar down capability), and emergency exit doors (without bar down capability)
• 13	exterior (key)		stairwells w/ access by key only
• 16	classroom (key)	PRK x L	interior exit doors from assembly spaces (with bar down capability)
• 10	exit only	none	interior double-egress doors (without bar down capability)
• 28	corridor fire door		electronic hold open
  - Use only rim devices.
  - Do not use exposed or concealed vertical rod devices.
  - All exit devices must comply with ADA requirements.
- Double Doors
  - Refer to Section 08000 for additional information.
  - Use removable mullions only where the "door bank" principle cannot be applied. U of A approval is required.
  - Restrict use of manual flush bolts to storage and mechanical rooms. Use dust-proof strikes.
  - Avoid use of automatic flush bolts.
  - Avoid use of coordinators; where unavoidable, use full width units in lieu of gravity arm.
  - Where required, use only T-type astragals notched around the strike.
- Locksets and Latches
  - Pre-qualified manufacturer is:
    - Sargent



- Use 8200 line labeled mortise locks at heavy duty applications such as:
  - Exterior ingress and egress doors
  - Classrooms
  - Stairwells
  - Use "L" rose and "L" lever for trim design selection
- Use 10 line cylindrical locks at all other general use applications.
  - Use "L" rose and "L" lever trim design selection.
- Generally use the following functions in the noted applications. Use of other functions may be required by User and U of A Lockshop.

• 05	office (toggle)	all "assigned" interior applications (offices, laboratories, etc.)
• 37	classroom (key)	all "shared" interior applications (classrooms, lecture halls, etc.)
• 04	always locked	restricted interior applications (animal quarters, bio-hazard labs, radio-hazard labs, etc.) and all interior and exterior service spaces (mechanical rooms, equipment rooms, telecomm rooms, always locked storage rooms, custodial closets, etc.) and ground level stairwell exit doors.
• 15	passage	interior closets, etc.
• 65	privacy	single person toilet rooms
• 480	auxiliary lock	corridor toilet rooms
- 2-3/4" backset
- Only "asa" type strikes with no filing or other modifications to make fit.
- In renovation applications, comply with these requirements regardless of the style of existing locks and latches unless directed otherwise by Project Manager.
- All knobs, handles and levers shall comply with ADA requirements.
- Digital Locksets
  - Use only OMNILOCK digital locksets by OSI Security Systems, Inc. For all applications utilize OMNILOCK Cylindrical Lockset part number OM300-C-SR-626-STD-WX-P. This is a cylindrical lockset requiring a 2 1/8" diameter bore and a 2 3/4" backset.
- Cylinders and Keying
  - Specify that all locks and latches be shipped without permanent cylinders unless required by the Contractor for temporary access and security.
    - The University will install all permanent cylinders and perform all keying.
  - Require the Contractor to provide his own temporary construction, installation and "testing" cylinders.
    - On new buildings the University may provide temporary construction cylinders. Verify availability and quantities with Project Coordinator.
    - On all renovation projects the Contractor shall provide construction cylinders, keyed alike. Provide 2 keys per cylinder to the U of A.
  - Interchangeable or removable core cylinders are not employed by the University system and are not acceptable.
- Miscellaneous Hardware

- Specify all required miscellaneous hardware, including:
  - Stops (wall-type are preferred)
  - Kickplates on heavy traffic doors (classrooms, conference rooms, laboratories, etc.)
  - Thresholds, door bottoms, and weatherstrips on all exterior doors.
  - Interior smoke and door seals surface mounted or adhesive backed.
- Finish
  - BHMA 626 (US 26D), satin chrome plate, uncoated
  - BHMA 630 (US 32D), satin stainless steel, uncoated
- Hardware Schedule
  - Include a specific hardware group schedule, with group designations to be used on the drawings.
- **Part 3 - Execution**
  - Coordinate with other trades (Division 6 and Division 9) location of backing required for surface applied hardware.
  - Make sure that installation is specifically described, here or in the appropriate Division 6 section.
  - Require that all hardware including temporary test cylinders be installed, and all doors tested and adjusted for proper operation, prior to Substantial Completion.
  - All door closers shall be readjusted after the air balance is complete.
  - Latches shall be centered in strikes. i.e. filing of strikes is strictly prohibited.

**End of Section 08710**

## **DIVISION 8 – DOORS AND WINDOWS**

### **Section 08711 – Finish Hardware; Residence Life**

#### **Introduction**

The University of Arizona Residence Life, has determined that, based on its experience with the performance and durability of the products described in this Section, and based on the benefits of limiting the range of repair parts which must be maintained in inventory, a proprietary specification is in the best interest of the University.

Also, to ensure compatibility of door hardware with the unique key system utilized within the University of Arizona Residence Life, specific door hardware must be used.

Specify all hardware for a fully functioning, secure, weatherproof installation for all swinging, sliding, and folding doors.

Include unique door or frame dependent hardware in those sections.  
Include cabinet hardware in the appropriate Division 6 section.

In renovation projects, specify hardware which matches the existing hardware type for function, appearance, trim, and finish, except where other overriding considerations such as handicapped accessibility require deviations. The Consultant must determine the existing conditions and specify materials which match those conditions. Requiring the Contractor to “match existing as required” is unacceptable.

In special cases, hardware different from those items described below may be required. In such cases, secure specific permission of the Project Manager. These cases may include:

Alarmed exit devices  
Electronic access control  
Matching “period” hardware in historic buildings

Include on the drawings a schedule indicating which specific hardware group applies to each individual door. Pay particular attention to identifying the desired function of each door lockset.

#### **Part 1 – General**

- Require submittal of a complete hardware schedule describing each door and each hardware group.
- Require that the supplier of finish hardware have as a full-time employee a regular member of the American Society of Hardware Consultants, and that the hardware schedule be prepared by the AHC member.
- Require delivery to the Owner upon Substantial Completion all adjusting tools, keys, dogging keys, and other maintenance materials.

#### **Part 2 – Products**

- **Butts**
- Pre-qualified manufacturers are:
  - Hager
  - Lawrence
  - McKinney
  - Stanley
  - Minimum 1 ½ pairs per door
  - Always ball bearing
  - Always non-removable pins
  - Full length continuous hinges are **NOT** to be used without prior approval of Project Manager.
- **Closers**

- Use LCN 4040 series at all applications, unless prior approval of Project Manager.
- Non-handed, adjustable size, 4 way mountable.
- Cast iron body.
- Closers will be mounted for 180 degree opening unless configuration requires other mounting location.
- Require through-bolt installation at wood doors. Metal doors will be installed in reinforced areas. Preferred installation is on door. If jamb mounting is necessary, all holes to be drilled and tapped.
- Closers will have 10 year manufacturer warranty.
- All closers must comply with ADA requirements. ADA openings shall be equipped with DA (delay action) closers. Closure speed adjusted to 7 seconds (latching speed).
- Use only wall mounted hold open devices where doors with closers are intended to be normally open. (These units must be tied into existing fire alarm system if used).
- All closers will be readjusted upon project completion for environmental conditions in building.

- **Exit Devices**

- Pre-qualified manufacturers are:
  - Von Duprin 99 series.
  - Von Duprin 99-F for fire rated openings.
  - Von Duprin 33 Series for narrow stile.
  - Concealed vertical rod devices will **NOT** be used without prior approval of Project Manager.
  - On non-fire rated openings, key operated removable mullions will be used. (Von Duprin KR54 removable mullion).
- Use the following functions and trims in the noted applications; use no other functions or trim (these designations are based on Von Duprin products).

<u>ANSI Function</u>	<u>Trim</u>	<u>Use</u>
• 03	NL	Entrance/exit doors (non-fire rated) exterior
• 03	L-F	Stairwell doors requiring key access
• 08	L-F	Fire rated openings
• 08	L	Openings from/into conference rooms

- Use only rim devices.
- All exit devices must comply with ADA requirements.

- **Double doors**

- Refer to section 08000 for additional information.
- Use key operated mullions where ever applicable.
- Restrict use of manual flush bolts to storage and mechanical rooms. Use dust proof strikes.
- Avoid use of automatic flush bolts. Use requires prior approval of Project Manager.
- Avoid use of coordinators; where unavoidable, use full width units in lieu of gravity arm.
- Where required use only t-type astragals notched around the strike.

- **Locks and latches**

- Pre-qualified manufacturer is:
  - **Best (no substitute)**
- Use Best 93K series cylindrical locks at all general use applications.
  - Use C rose and 15 lever trim designation
  - **SFIC Interchangeable core function REQUIRED. Best specification code (7).**
- Generally use the following functions in the noted applications. Use of other functions may be required by User and Residence Life.

<u>ANSI Function</u>	<u>Best Function</u>	<u>Use</u>
----------------------	----------------------	------------

F90	T	Dormitory rooms
F109	AB	Offices
F86	D	Storerooms, closets, mechanical
F84	R	Corridors, conference rooms

- 2 ¾" backset.
- Only ANSI 4 7/8" strike (Best code S3) to be used.
- In renovation applications, comply with these requirements regardless of the style of existing locks and latches unless directed otherwise by Project Manager.
- All knobs, handles and levers shall comply with ADA requirements.
- **Cylinders and keying**
  - Specify that all locks and latches be shipped without permanent cylinders unless required by Contractor for temporary security.
  - Residence Life Access Control Systems will supply and install all permanent cylinders and perform all keying plans.
  - Require the Contractor to provide his own temporary construction, installation and testing cylinders.
  - Interchangeable SFIC format removable core cylinders are required.
- **Miscellaneous Hardware**
  - Specify all required miscellaneous hardware, including:
    - Stops (wall type preferred)
    - Kickplates on heavy traffic doors (conference rooms, corridor doors)
    - Thresholds, door bottoms, and weatherstrips on exterior doors.
    - Interior smoke seals (similar to Pemko 312, do not use adhesive application).
  - **Finish**
    - BHMA 626 (US26D), satin chrome plate, uncoated
    - BHMA 630 (US32D), satin stainless steel, uncoated
  - **Hardware Schedule**
    - Include specific hardware group schedule, with group designations to be used on the drawings.

### Part 3- Execution

- Coordinate with other trades (Division 6 and Division 9) location of backing required for surface applied hardware.
- Make sure installation is specifically described, here or in appropriate Division 6 section.
- Require that all hardware including temporary test cylinders be installed, and all doors tested and adjusted for proper operation, prior to Substantial Completion.
- All door closers shall be readjusted after the air balance is complete.
- Latches shall be centered in strikes, i.e. filing of strikes is strictly prohibited.

### End of Section 08711

## **DIVISION 08 - DOORS AND WINDOWS**

### **Section 08720 - Automatic Door Operators**

#### **Introduction**

The University of Arizona has determined that, based on its experience with the performance and durability of the products described in this Section, and based on the benefits of limiting the range of repair parts which must be maintained in inventory, a proprietary specification is in the best interest of the University.

Require automatic door operators on at least one door leaf at each entrance intended or expected to be available for general ingress/egress use. *Automatic door operator locations will be approved by the University of Arizona.*

Use sliding automatic door operators only with the specific permission of the Project Coordinator.

Do not use the following products:

- Motion detectors
- Pressure mats

Coordinate electrical requirements on the drawings.

#### **Part 1 - General**

- Require that the supplier(s) and installer(s) demonstrate 5 years of successful installations of similar systems.

#### **Part 2 - Products**

- *Approved manufacturer and models are:*
  - *Horton Series 7000 (medium duty) for interior doors, 3'-0" or smaller*
  - *Horton Series 4000 (heavy duty) for exterior doors and interior doors greater than 3'-0".*
- Generally, specify the following features:
  - Electro-mechanical, swing operation
  - Sealed transmission
  - All metal gears
  - Interior, push side, surface, top jamb, mounting
  - Key controlled power shut-off
  - 3-second "door stalled" safety feature
  - Automatic assist on manual operation
  - Remote battery operated radio frequency, square push plate control, wall mounted, 2 for each door
  - Power on/off switch accessible on surface of operator.
- Safety rails are required but need not necessarily be the door operator manufacturer's standard products. Rails may be specified to harmonize with the overall building design.

#### **Part 3 - Execution**

- There are no unique University requirements in this Section.

#### **End of Section 08720**

## **DIVISION 8 - DOORS AND WINDOWS**

### **Section 08800 - Glazing**

#### **Introduction**

Glass is a major maintenance issue for the University due to breakage from accidents and vandalism. The Consultant is encouraged to use light sizes which are easily replaced by the University, and carefully consider the use of any specialty glazing.

#### **Part 1 – General**

- Provide calculations for thermal stress, wind load, and structural requirements. Calculations for thermal stress should relate to partial, full and seasonal shading effects.
- Avoid the use of film applied to exposed surfaces of glass whenever possible.
- Wired (safety) glass is not allowed in any application
- Tinted/colored glass or spectrally selective glazing shall be reviewed and approved by the UA FDC Project Manager.

#### **Part 2 - Products**

- Exterior Window Openings
  - Standard Glazing: 1" insulating units with solar control low emissivity (low-e) coating
    - Use heat treated glass as required by thermal stress analysis
    - Use laminated glass for obscure or translucent glazing
  - Safety Glazing: 1" insulating glass units, where required by code, either fully tempered (FT) or laminated
  - Spandrel Glass
    - Use heat treated glass as required.
    - Space immediately behind Spandrel glass shall be adequately vented.
- Interior Window Openings
  - Standard Glazing: Annealed float or laminated
    - Use laminated glass for obscure or translucent glazing
  - Safety Glazing: where required by code, either fully tempered (FT) or laminated
- Fire-rated Glazing
  - Due to high cost of installation and replacement the use of fire rated glazing should be carefully considered during the design and approved by the UA FDC Project Manager.
    - Transparent ceramic (used as part of an insulating unit if exterior rated glazing is required).
    - Transparent wall units designed as a barrier wall (inert material turns to foam during a fire)
- Specialty Glazing
  - Coordinate approval of specialty glazing such as bullet resistant, acoustical, one way viewing, projection booths, etc. with UA FDC Project Manager to determine products that will meet specific needs.
  - Ceramic pattern may be used if reviewed and approved by UA FDC Project Manager.

- Mirror Glass: shall be framed in stainless steel and shall have a backing sheet.

**Part 3 - Execution**

- Mirrors shall be set with theft-proof mounting.

**End of Section 08800**



## DIVISION 9 - FINISHES

### Section 09000 - General Discussion

#### Introduction

Next to thermal and moisture protection, finishes are most critical to the projects' appearance over the long term. University facilities must have a useful life of forty to fifty years. Over this period of time there will be many changes and alterations to the building. Many user groups will occupy the facility and many students will pass through its doors. What the building will look like after a short or long period of time will be reflected in the selection of finishes and the ease of maintenance that can be provided by University staff. Also important in the appearance of the building will be the convenience and the availability of storage space for janitorial equipment and access to convenient janitor closets. These closets should be well thought out in the initial design and not become after thoughts randomly located. They should also not become the arbitrary repositories for miscellaneous items that were not considered in early design stages (i.e.: water heaters, terminal boards, mail cart storage, etc.).

- Excessively light or dark colored finishes should be avoided (especially black). Both are difficult to maintain.
- Ceramic tile should be applied to wall areas adjacent to drinking fountains or areas where water might splash and cause staining or deterioration of wall surfaces.
- Carpet should of a pattern, color or texture which will provide for wear and soil hiding characteristics. Buildings on the campus generally have the carpet cleaned annually. Funding for more frequent cleaning is not available.
- Appropriate materials should be considered for high traffic areas and mats or grilles should be placed at entries to facilities.
- Equally important are impervious floor covering materials at potentially wet areas such as toilet rooms, drinking fountains and adjacent to sinks in work areas and even conference rooms where coffee may be served ( and spilled).
- Smooth wall surfaces are to be avoided. Patches and blemishes will show.
- Protection of walls and corners shall be provided in areas where carts or other items might damage wall surfaces. A wood base or chair rail may be appropriate in heavy duty areas.
- Marble is an absorbent material which stains easily and is difficult to clean. It should be applied to vertical surfaces only.
- Shiny, mirror like surfaces should be avoided, especially where touching is possible. These surfaces require additional maintenance and may not be maintained in the condition the designer intended.
- *For flooring applications on concrete slabs on grade special precautions are typically necessary to alleviate the concerns for vapor transmission. Refer to Section 03300.*
- *To alleviate flooring material concerns associated with moisture transmission and emission through concrete slabs on grade the following preventive measures shall be prescribed.*
  - *An under slab vapor barrier should be specified and detailed directly under the concrete slab and on top of any subgrade or sand grading material to minimize moisture transmission through the slab. Vapor barrier shall meet the requirements ASTM E-1745 Class "C". Acceptable vapor barriers are "Stego Wrap" by Stego Industries and "Moistop Plus" by Forfiber Building Products Systems.*
  - *A low water to cement ratio, low slump concrete should be specified for all interior slabs where flooring is anticipated to minimize the amount of free water in the concrete. Sufficient time should be allowed with the project to allow any free moisture to evaporate from the slab.*
  - *Surface sealers such as "Para-Seal" by Parabond may be considered for re-flooring applications on existing slabs.*

Common sense should prevail in the selection of materials and consideration give to the fact that the University is a public facility used by thousands of people daily. Maintenance budgets are minimal and design elements which create hardships will not be attended to. This challenge can still foster creative ideas to resolve the design problem.

**End of Section 09000**

## **DIVISION 9 - FINISHES**

### **Section 09100 - Metal Support Systems**

#### **Introduction**

This section refers to light gauge metal framing and should use a "performance specification". Do not specify proprietary manufacturer's names or materials, and do not restrict vendors to a limited list.

In areas where partitions are subject to severe impact loads, and in situations where fixtures and appurtenances are intended to be supported directly from partitions, require the installation of backing and/or blocking in the partitions, according to the following criteria. Describe the locations for all backing and blocking on the drawings. Considerations for blocking are as follows:

Specify appropriate size/gauge of metal backing for support of heavy wall hung fixtures, handrails, etc., with a minimum load resistance capacity of 200 lbs. in any direction.

3-1/2" blocking at the bottom of heavy duty partitions where resilient floors are scheduled to be installed (to protect wall from floor cleaning equipment impacts)

Provide blocking at points of attachment for small fixtures, toilet accessories and partitions, handrails, door stops, etc. Blocking shall be 2x6 minimum fire retardant treated wood blocking or 6" wide 20 gauge (sheet metal gauge) galvanized sheet metal with a minimum wall thickness of 0.0356" (0.0400" nominal).

Coordinate this Section closely with Section 09200 Lath and Plaster and Section 09250 Gypsum Board.

#### **Part 1 - General**

- These standards shall be applicable unless the partition or wall is specifically designed otherwise.
- All cold formed steel shall comply with SSMA.

#### **Part 2 – Products**

- Prescribe all studs to be minimum 20 gauge (steel stud gauge) with minimum wall thickness of 0.0300" (30 mls). Locate all studs at 16" OC.

#### **Part 3 - Execution**

- Require that all metal support systems attached to the structure above (including floor tracks, ceiling tracks, and perimeter wall studs) be installed using only drilled anchors. Powder driven fasteners are allowed if installed with minimum 1" long shot pins (.145 shank size) are used with the correct load.
- Specify neoprene gaskets under runner tracks and perimeter studs at acoustical-rated partitions. Floor runner tracks (and some ceiling tracks) to be set in a bead of caulking.
- Specify framing intersections and special conditions as follows:
  - Three studs or floating stud at all corners
  - Double 20 gauge studs at door jambs, and each side of openings & end of wall terminations
  - Double studs both sides of expansion joints
  - Floating stud (slip track) at ceiling conditions where deflection is anticipated.
  - Provide double studs at all door openings with studs secured together on both sides.

- Intermediate bracing located at midspan for wall heights exceeding 12'. For walls greater than 12' intermediate bracing shall be placed at 6' OC vertically. Provide minimum ¾" cold rolled channel bridging with clips at each stud.
- Specify blocking and attachment devices to be provided where shelves or casework are installed.
- All walls enclosing plumbing waste or vent lines to be appropriately sized to accommodate plumbing lines and/or 6" minimum in depth unless a chase is provided.

**End of Section 09100**

## **DIVISION 9 - FINISHES**

### **Section 09200 - Lath and Plaster**

#### **Introduction**

Coordinate this Section closely with Section 09100 and other sections to which plaster and/or "stucco" may be applied.

Lath and plaster installations shall be detailed on the drawings, to the extent not sufficiently established by industry standards and to avoid misunderstandings. Pay particular attention to substrates, intersections, joints, expansion and contraction.

Avoid integral color plaster due to inconsistencies of color mixing. Apply plaster in standard gray color and finish with paint to seal and provide desired color.

#### **Part 1 - General**

- Lath and plaster work shall be in accordance with the recommendations of the following:
  - "Portland Cement Plaster (Stucco) Manual" published by the Portland Cement Association
  - "Specifications for Metal Lathing and Furring" published by the Metal Lath/Steel Framing Association, a division of the NAAMM
  - "Plaster/Metal Framing Systems/Lath Manual" distributed by the Plastering Information Bureau of California
- On major new projects, require a field constructed mock-up for verification of texture, assembly, and details. The mockup shall be maintained at the job site until the end of the project.
- Generally, remodeled plastered areas shall be plaster board with plaster finish coats as required and new plastered walls shall be the Imperial plaster board base with Imperial plaster finish.

#### **Part 2 - Products**

- Expanded metal lath shall be self-furring, 3.4 lbs./sq. yd., diamond mesh, galvanized steel sheet for exterior use and wet interior areas.
- Plaster on masonry shall be two coat type work and on wood or steel framing shall be three coat type work. Mix design shall be verified before plastering operations begin and shall include alkaline resistant glass or polypropylene fiber reinforcement strands.
- Plaster accessories shall be metal. Small-nose corner beads shall be fabricated of zinc alloy and have expanded flanges of large mesh diamond lath for plaster embedment. Casing beads shall be square-edge type.
- Expansion joints shall be one piece type in "M" shaped configuration, with expanded metal flanges, except 2-piece type may be used where expansion exceeds the one piece capabilities.

#### **Part 3 - Execution**

- Provide for expansion in exterior and interior plaster installations. Locate expansion joints where recommended by standards, but not more than ten feet on center nor defining panels greater than 100 square feet. Re-entrant corners shall have expansion joints provided.

- Moist cure Portland cement plaster in accordance with the requirement of ASTM C926, including “Annex A2 Design Considerations”

**End of Section 09200**

## **DIVISION 9 - FINISHES**

### **Section 09250 - Gypsum Board**

#### **Introduction**

This is a section where the consultant should use a "performance specification". Do not specify proprietary manufacturer's names or materials, and do not restrict vendors to a limited list.

Do not specify gypsum board for exterior finish applications. Specify Portland cement glass mesh board or lath and plaster for soffits.

Describe locations for all expansion joints in gypsum board walls and ceilings on the drawings.

Coordinate this Section closely with Section 09100 Metal Support Systems.

#### **Part 1 - General**

- Identify as reference standard the criteria of the following organizations:
  - The Gypsum Association
  - The United States Gypsum Company (the non-proprietary aspects of the Gypsum Construction Handbook)
- Do not interrupt gypsum board at fire resistant partitions for blocking, ceramic tile backer boards, or other construction.

#### **Part 2 - Products**

- Require use of 5/8" gypsum board panels throughout. Allow use of 1/2" panels only in concealed conditions such as pipe chases and air plenums (subject to fire-resistant requirements).
- Specifically call for use of fire-resistant, moisture-resistant, and combination fire-and moisture-resistant panels, where required.
- Require use of maximum practicable panel lengths to reduce number of joints.
- Specify only metal trim, joints, and accessories, designed for mechanical attachment.

#### **Part 3 - Execution**

- Specify only screw attachment for gypsum panels to both wood and metal framing, and for all trim, joints, and accessories.
- Require that vertical joints be staggered 1/2 panel.
- Require that gypsum panels be installed continuous over openings, and extend at least 1 full stud beyond the opening edge.
- Specify "floating stud" and "floating corner" installation techniques.
- Specifically describe requirements for installation and spacing of expansion joints in walls and ceilings.

- Specify finish textures for interior spaces as follows:
  - Light skip trowel to match the Owner's sample in new areas such as offices, corridors, classrooms, conference rooms, libraries, etc.
  - Light stipple in wet or sanitary areas
  - Smooth finish, if necessary, shall be specified in Section 09200 - Lath and Plastering
  - Match existing surface textures in areas where existing walls are retained

**End of Section 09250**



## **DIVISION 9 - FINISHES**

### **Section 09330 - Tile**

#### **Introduction**

Tile work shall be designed and specified in accordance with the current edition of the "Handbook for Ceramic Tile Installation" of the Tile Council of America" (TCA). Indicate extent and any patterns of tile work on the drawings. Provide details for setting beds and joints. Generally tile shall not be installed with organic adhesive on "green board". Provide details for setting beds, expansion and control joints, waterproofing, and drain seals.

Retrofit of existing showers in Residence Life facilities as well as new installations which provide handicapped access to showers shall be carefully studied and floor slopes, floor drain locations and waterproofing shall be carefully analyzed and detailed.

Preferred tile sizes for toilet room floors are 1" x 1" or 2" x 2" maximum size only, unglazed for slip resistance.

#### **Part 1 - General**

- When patching tile in existing areas, develop a pattern rather than merely replacing required tile.
- Dark mortar colors are preferred.

#### **Part 2 - Products**

- Products shall comply with ANSI Standard A137.1, "American Standard Specifications for Ceramic Tile". Tile shall be "Standard Grade".
- Do not mix manufacturers. It is preferred that all tile for a project be from one manufacturer.
- Unglazed ceramic mosaic tile shall be porcelain type, plain face with eased edge, factory mounted, 1/4" thick nom.
- Glazed wall tile shall be bright or matte face, 5/16" thick, flat plain face with cushion edge.
- Unglazed quarry tile for floors shall be 3/8" to 1/2" thick, matte finish, flat face, cushion edge. Non-slip surface is required in wet areas such as kitchens, showers, locker rooms, and exterior areas where rain may mix with dust and make a slick surface.
- Trim units shall match characteristics of field tile. Bases shall be straight type; edges shall be bullnose.
- Setting materials, grouts and sealants shall be appropriate for the installation method.
- Provide cement board or a non paper gypsum board for tile substrate at all wet locations.

#### **Part 3 - Execution**

- Installation shall be in accordance with Tile Council of America Standards (TCA).
- Specify the setting method for each type tile and location by reference to TCA standards. Generally all tile installations shall be thin set except sloped floors and shower floors where mud set shall be used.
- Coordinate and detail expansion joints with building details.
- Where not supplied on a backing material, tile shall be placed with metal grid template. Do not use spacer buttons on tile edges. Tile joints shall be 1/8" in width.

- Joint between floor and wall tile shall be caulked with urethane, not grouted.
- Grout shall be sealed by Contractor and surface protected until acceptance.
- Provide a maintenance materials list. Extra stock consisting of one (1) box of each color and type of tile used in the project shall be provided.

**End of Section 09330**

## **DIVISION 9 - FINISHES**

### **Section 09500 - Acoustical Treatment**

#### **Introduction**

The selection and specification of acoustic ceiling systems should be based on a careful analysis of functional, aesthetic, and cost criteria. Fire resistance, sound absorption, noise reduction, durability, and appearance considerations will combine to narrow selection choices to a range of a few acceptable alternatives, so that cost may serve as a final determinant to list of two or three acceptable products for bid.

Ideally the specification should be performance-based, but it is in the University's best interest in acoustical ceilings to inform bidders through semi-proprietary specifications which describe essential characteristics and name a selection of 3 or more products by different manufacturers which the Consultant has determined meet the functional and aesthetic requirements.

Acoustic ceiling material specifications should list required type, form, pattern, noise reduction coefficient or articulation class, ceiling sound transmission class, light reduction coefficient, flame spread, fire resistance classification, and sanitation. On projects with unique requirements, such as performing theater or auditorium, a special acoustic consultant should be considered to advise the Consultant in the design of the space as well as the acoustic materials of the spaces.

#### **Part 1 - General**

- Ceilings in general areas (offices, corridors, public spaces) should generally be 2' x 4' square-edged lay-in panels.
- Ceilings utilizing a 2 X 2 grid and/or regular tile may also be considered if approved by the Project Manager.
- Entry lobbies and conference rooms may use tile and grids with more design oriented features.

#### **Part 2 - Products**

- Technical characteristics shall generally comply with the following
  - Color/Light Reflectance            White/LR not less than 0.75
  - Noise Reduction Coefficient      NRC not less than 0.70
  - Ceiling Attenuation Class        CAC not less than 35
- Grid shall be heavy duty or intermediate

#### **Part 3 - Execution**

- Grid
  - Tie tracks and grid tightly to allow easy tile removal.
  - Wires shall not be kinked and tails shall be cut
  - Do not hang from non structural elements.
  - Seismic bracing is not required.
  - Powder driven fasteners are allowed if installed correctly, i.e., proper load and pin length. Otherwise drilled anchors shall be used.
  - Provide separate wires for hanging light fixtures.
  - Dimension cuts and borders. Control the grid layout with dimensions, do not rely on a "balanced" layout.

- Trapezes shall be installed where interference's are encountered during the installation
- Remodel or renovation projects may require that the existing grid be painted. Do not paint the existing tile and reuse it. Provide new tile.
- Provide a detailed materials list with manufacturers name, lot number, stock number, name, color, etc. An extra stock of material shall be provided.

**End of Section 09500**

## **DIVISION 9 - FINISHES**

### **Section 09650 - Resilient Flooring**

#### **Introduction**

Carefully consider the areas for installation of resilient flooring. In addition to corridors, toilet rooms, elevators, classrooms, laboratories and the like, resilient flooring should be provided in work rooms, lounges, lunch rooms and areas adjacent to counter top sinks where food, beverages and the like could be spilled and soil other floor covering materials. Also consider areas in conference rooms where coffee might be served (and spilled).

#### **Part 1 - General**

- There are no unique University requirements.

#### **Part 2 - Products**

- Wall base shall be rubber cove type, 4" high. Outside corners shall be premolded.
- Flooring products
  - Flame Spread                      Less than 75 (ASTM E84)
  - Smoke Developed                Less than 450 (ASTM E84)
  - Smoke Density                    Less than 450 (ASTM E84)
- Vinyl Composition Tile - FF SS-T-312, 12" x 12" x 1/8", composition 1, asbestos free.
- Sheet Vinyl - FS L-F-475, Type II, Grade A, 125 psi minimum static load limit, 0.080" thick min., 6'-0" wide, filled, without backing.
- Adhesive - Recommended by the flooring manufacturer and asbestos free.

#### **Part 3 - Execution**

- Provide 6" high integral cove base on sheet vinyl floors, with metal trim and corner shoes in laboratories and where wash downs occur. All other areas shall have standard cove rubber base.
- Floors shall be cleaned, stripped and waxed by the Contractor. Products shall be compatible with U of A custodial products. Protect until acceptance.
- Provide a detailed materials list. Provide an extra stock of materials.

#### **End of Section 09650**

## **DIVISION 9 - FINISHES**

### **Section 09680 – Carpet and Carpet Tile**

#### **Introduction**

In general, broadloom carpet shall be direct glue down installation.

In certain limited and special cases (for example offices of senior academic or administrative officials requiring an "executive" environment), and only with specific permission from the Project Manager, a carpet or carpet tile with enhanced cushion backing may be used. Carpet stretched over carpet padding systems should *not* be specified.

Classrooms – Where carpeting is recommended by the design professional for classroom installations, only carpet tile shall be specified. In deciding to use carpet tile in classrooms, acoustical, comfort and appearance issues should be weighed against FM maintenance issues (UA PM to coordinate). In large classrooms i.e. auditorium or tiered classrooms, the use of carpet tile is restricted to aisles and entry levels. Do not specify carpet tiles under fixed seating.

Selection of carpet materials (and enhanced cushion backing systems) must adhere to all pertinent ADA requirements.

Selection of carpet materials (and enhanced cushion backing systems) should address the traffic characteristics, likelihood and types of potential staining agents, and required longevity of the installation.

Carpet selections should take advantage of sustainable carpet options as much as possible. Consideration should be given to the sustainable importance of toxins that the yarn systems may or may not have, the backings used, and the potential for re-cycled or "post-consumable" content.

When selecting carpet materials, consider that the carpet will be cleaned only annually. Specify materials choices which provide substantial wear and soil hiding characteristics. Also consider that regular vacuuming will be accomplished with heavy duty equipment. Delicate carpet requiring special attention will not prove durable.

Limit color choices to those which will provide substantial wear and soil hiding characteristics. Restrict solid color carpet to accent areas. Do not use light colors.

Where carpet is being installed directly over asbestos-containing resilient flooring ("encapsulation"), specify a releasable installation, using "peel-and-stick" materials or special adhesives. Encapsulation is decided by the University on a case by case basis.

Do not specify carpeted floor finishes in wet locations such as toilet rooms, locker rooms, wet laboratories, and other similar spaces. This includes small areas within larger spaces such as around coffee bars, drinking fountains, entry vestibules, etc.

Include carpet type, color and pattern selections, and any special layout provisions (borders, etc.) in the construction documents.

Coordinate requirements for resilient base and accessories with Section 09650.

#### **Part 1 - General**

- Require that manufacturer(s) and installer(s) demonstrate at least 5 years successful performance with similar installations.
- Require submission of manufacturer's technical literature, test reports, VOC content, and flame spread characteristics.

- Require submission of a seaming diagram, drawn to scale, clearly indicating all special features of each space required to receive a carpeted finish, and the planned seaming pattern.
- Require submission of an "as-built" color and material schedule for each carpet installed, with the closeout documents, including:
  - Descriptive location
  - Manufacturer
  - Carpet type (name and number)
  - Color, style and pattern (name and number)
  - Manufacturer's recommended cleaning procedures
  - Warranty provisions
- Require delivery to the Owner of maintenance stock, a minimum of 9 square yards or 3% of the total whichever is larger, with no individual piece smaller than 3'-0" and 9 square yards, for each type and color of carpet in the project. For small projects a minimum of 5% stock should be considered. Include the following wording with the maintenance stock specification - "It is unacceptable to consider this maintenance stock for standard installation overages. This is "attic stock" to arrive on site cleanly wrapped and labeled as "attic stock" for the client to use in future repair and maintenance. It is not considered as waste stock or overages that the contractor bids for installation purposes."
- Specify special warranty provisions as follows:
  - Two Year Installation Warranty: signed by the contractor and installer, agreeing to repair or replace defective materials and workmanship over a TWO year period.
  - 10 year, non-prorated manufacturer's warranty.
    - Delamination warranty: The backing will not delaminate for the life of the carpet.
    - Edge Ravel Warranty: The Manufacturer warrants that the carpet will not have continuous ends coming out at lengthwise seams for the life of the carpet.
    - Tuft Bind: The manufacturer warrants that the carpet has an average face yarn tuft bind of 20 pounds. This warranty is for the life of the carpet and applies only to loop pile carpet.
    - Static Warranty: The Manufacture warrants that the carpet will not give static discharges in excess of 3KV when tested under AATCC Test Method # 134-1979 for the life of the carpet.
    - No more than 10% loss of pile by weight
    - No zippering.
    - Chair pads must not be required to maintain the warranty.
    - Warranties must be from the carpet manufacturer, and must be offered as the manufacturer's warranty.

## Part 2 - Products

- Specify carpet, enhanced cushion backing (where required), adhesive, and seaming materials, which meet the University of Washington protocol for volatile organic compounds (voc), with the minimum possible content of voc, and in no case with a total voc content in excess of 0.50 mg per cubic meter.
- Specify carpet complying with these general criteria:
  - Flame spread - class I
  - Smoke density - less than 450
  - Static resistance - minimum of 3.0 kv
  - Tuft bind - minimum 20 lbs
  - Dyed fibers – only branded yarn dyed or solution dyed fibers shall be specified

- High Traffic Areas (libraries, conference rooms, classrooms, corridors, etc.)
  - Carpet fiber - type 6.6 cationic polymer nylon, 4 ply, hollow bcf filament, solution or yarn dyed.
  - Construction - woven
  - Texture - level loop
  - Density - 7,000
  - Face weight - 17 ounces per square yard minimum.
  - Primary backing - to meet warranty provisions above.
  - Secondary backing - to meet warranty provisions above.
  - Width - 12 ft for broadloom, 18" to 36" square for carpet tile.
  
- General Use Areas (offices, etc.):
  - Carpet fiber - type 6.6 cationic polymer nylon, 4 ply, hollow bcf filament, solution or yarn dyed.
  - Construction - tufted or woven.
  - Texture - level loop
  - Density - 5,000 to 7,000
  - Face weight - 17 ounces per square yard minimum.
  - Backing - unitary or action back.
  - Width - 12 ft. for broadloom, 18" to 36" square for carpet tile.
  
- Hospital / Medical Facilities:
  - Carpet fiber - type 6.6 cationic polymer nylon, 4 ply, hollow bcf filament, solution dyed (no yarn dyed allowed).
  - Construction - tufted or woven
  - Texture - level loop
  - Density - 5,000 to 7,000
  - Face weight - 25 ounces per square yard minimum.
  - Primary backing - 100% vinyl
  - Secondary backing - 3/16" closed cell vinyl cushion.
  - Width - 6 ft. for broadloom, 18" to 36" square for carpet tile.
  
- Residential Facilities:
  - Because of the variety of facilities (new, renovated, need for allergy free, long term and short term) that Residence Life deals with; the Consultant shall discuss with the User the appropriate type of material to be specified for the specific project.
  
- Carpet with Enhanced Cushion Backing:
  - Carpet fiber - type 6.6 cationic polymer nylon, 4 ply, hollow bcf filament, solution or yarn dyed.
  - Construction - tufted or woven
  - Texture - cut pile
  - Density - 5,000 to 7,000
  - Face weight - 25 ounces per square yard minimum.
  - Width - 6 foot or 12 ft. for broadloom, 18" to 36" for carpet tile.
  
- Specify that adhesives and seam sealers must be furnished by or approved by the carpet manufacturer.



### **Part 3 - Execution**

- Require floor leveling, for both new and renovation projects, in this Section.
- Require that installation be accomplished in accordance with manufacturer's recommendations, including seam gluing.
- Include requirements for pattern matching, color matching, and running the pile in the direction of anticipated traffic.
- Describe requirements protecting installed carpet until Substantial Completion in this Section.

**End of Section 09680**

## **DIVISION 09 - FINISHES**

### **Section 09900 - Painting**

#### **Introduction**

This Section applies to exterior and interior areas or surfaces which are intended to receive a final painted finish. Final painted finishes serve two primary purposes:

- Provide a satisfactory protective coating for the surface
- Provide an aesthetically pleasing finish

When contemplating a painted finish for a particular surface, consider that the surface must be realistically accessible for maintenance and repainting in the future.

Develop separate Sections for special coatings and finishes which are not traditionally considered "painted finishes", such as gymnasium floor finishes, corrosion resistant finishes, concrete floor sealers, concrete and masonry wall sealers, tennis court surfacing, etc.

Include a paint or finish schedule, listing colors, locations, and types of materials, on the drawings.

#### **Part 1 - General**

- Do not specify painting for:
  - Prefinished items (e.g. toilet partitions, acoustical materials, light fixtures, finished mechanical/electrical/plumbing equipment in concealed areas, etc.)
  - Finished material surfaces (e.g. anodized aluminum, stainless steel, chromium plate, copper, plated hardware, rubber, etc.)
  - Concealed surfaces
  - Operating parts
  - Identification labels
  - Concrete steps, ramps, and sidewalks
- Identify the Painting and Decorating Contractor's of America (PDCA) Technical Manual as a reference standard.
- Require submission of manufacturer's technical information, label analysis, application instructions, and Material Safety Data Sheets (MSDS), for each material proposed for use. Include cross reference to the specific finish system(s) and substrate(s).
- Where precise color requirements are involved, specify a three-step color selection and approval process, including:
  - Selection from manufacturer's color chips
  - Verification from 12"x12" draw down cards
  - Final confirmation from actual samples in the field
- Field samples shall encompass at least 100 square feet, be applied on the actual substrate, utilize the entire finish system, and produce the required sheen, color, and texture under (simulated) final lighting conditions.
- When epoxy or lacquer materials are specified, include a requirement for providing positive ventilation of the spaces, and a requirement that the application be made after 5:00 p.m. on Friday (to allow odors to dissipate over the weekend).

- Require submission of an "as-built" color and material schedule for each substrate and finish system with the project closeout documents, including:
  - Descriptive location (room number, etc.)
  - Manufacturer
  - Paint type (name and number)
  - Color (name and number)

## Part 2 - Products

- Pre-approved paint manufacturers are: ICI Paint Stores, Dunn Edwards Corp., Frazee/Deer-O, Sherwin-Williams Paint Co., and *Pioneer Paint*
- Pre-approved stain manufacturers are: ICI Paint Stores, Dunn Edwards Corp., Frazee/Deer-O, Olympic (exterior use only), Sherwin-Williams Paint Co., and *Pioneer Paint*.
- Specify only manufacturer's first quality top-of-the-line 100% acrylic products, as described in the PDCA manual. Top-of-the-line products for approved manufacturers are:
  - **ICI Paint Stores**
    - Interior: #7500 Sintec High-Gloss Industrial Enamel, #SG45-11 Sinco Speed Semi-Gloss Enamel, #1698 Sinco Gloss Acrylic High-Gloss Enamel, #3000 Aqual Suede Low Sheen (Water based) Enamel, #UH4100 Glidden Ultra Eggshell
    - Exterior: #4800 Aqua Sash Acrylic Semi-Gloss Enamel, #1300 Stucco-Life Acrylic Flat, #DS 8700 Decrashield Acrylic Flat, #DS 8900 Decrashield Acrylic Semi-Gloss
    - McCloskey Exterior Satin Spar Varnish
    - DuPont Dp76P Acrylic Epoxy (water based)
    - DeVoe True Glaze Epoxy (water based)
  - **Dunn-Edwards Corporation**
    - Interior: W 440 Eggshell 100% Acrylic Interior Enamel, 9-Line Semi-Gloss Alkyd Synthetic Interior/Exterior Enamel, 10-Line Gloss Alkyd Synthetic Interior/Exterior Enamel, W 901 Semi-Gloss 100% Acrylic Interior/Exterior Enamel, W 450 Semi-Gloss 100% Acrylic Interior Enamel, V 199 Alkyd Semi-Gloss Varnish
    - Exterior: (In addition to those listed under interior) W 701 Flat 100% Acrylic Exterior Masonry Finish
  - **Frazee Paint Co.**
    - Interior: Lo-Glo Interior Acrylic Eggshell Enamel, Satin-Glide II Interior/Exterior Semi-Gloss Acrylic Enamel, Mirraglide Interior/Exterior Lo-Sheen Semi-Gloss and Gloss Acrylic Enamel,
    - Exterior: (In addition to those listed under interior) Dura-Tec Exterior 100% Acrylic Flat, Royal Supreme Exterior 100% Acrylic Lo-Lustre.
    - Alkyds: Aro-Plate II Synthetic Alkyd Gloss and Semi-Gloss Quick Drying, Aro-Guard water reducible 2 component Gloss Epoxy
    - Varnishes: McCloskey Brands - Heirloom Satin & Gloss, Man-O-War Polyurethane Satin & Gloss Varnish, Man-O-War Exterior Spar Varnish Satin & Gloss.
  - **Sherwin Williams:**
    - Interior: ProMar 200 Latex Eg-shel Enamel B20W201, ProMar 200 Latex Semi-Gloss Enamel B31W201, ProMar 200 Latex Gloss Enamel B21W201
    - Exterior: Gloss Alkyd - Industrial Enamel B54 Series, ProMar 200 Alkyd Semi-Gloss, A100 Exterior Acrylic Gloss A8 Series, A100 Exterior Acrylic Flat A6 Series

- Epoxy: Water-Based Catalyzed Epoxy B70 Series Gloss and Semi-Gloss.
- Varnish: Oil Based Satin Varnish A66F90
  
- Specify only materials which comply with all VOC regulations promulgated by the Environmental Protection Agency.
  
- Specify colors from manufacturer's complete standard range (the "fan deck"). Do not custom match paint colors to other materials. Limit the use of deep tint base colors to interior wood and metal trim only.
  
- Specify a minimum of 2 color coats on all new and existing surfaces.
  
- Specify complete paint systems (primers and finish coats) for each substrate and finish.
  
- Specify only primers which are specifically intended for each substrate.
  
- Interior gypsum board walls and ceilings: 100% acrylic low sheen enamel (25% - 35% gloss level, egg shell)
  - Classrooms
  - Offices
  - Corridors
  - Stairs
  - Dry laboratories
  - Janitor closets
  - Storage rooms
  - Equipment rooms
  - All other high use areas
  
- Interior gypsum board walls and ceilings: Water-based epoxy semi-gloss enamel (50% - 60% gloss level).
  - Wet laboratories (walls only)
  - Animal care areas
  - Certain medical care areas
  - Shower rooms
  - All other areas exposed to substantial moisture
  
- Toilet room gypsum board walls and ceilings: 100% acrylic semi-gloss enamel (50% - 60% gloss level). Use "pearl white" only.
  
- Interior metal doors, frames, and trim: 100% alkyd semi-gloss enamel (50% - 60% gloss level).
  - Do not use latex finishes on interior metal trim
  
- Repainting existing metal surfaces: 100% alkyd rust-inhibitive gloss enamel (80% minimum gloss level).
  - Toilet partitions (choose color from the manufacturer's standard range)
  - Elevator cars ("pearl white" only)
  
- Interior transparent finish wood doors, millwork, and trim: 100% alkyd satin varnish.
  - Stain wood only when matching existing stained materials
  - Specify same finish for interior and exterior surfaces of millwork
  - Specify acid-resistant finishes for laboratory millwork
  
- Galvanized metal.

- Prepare with a commercial galvanized metal preparation (i.e., Galva-wash); do not use vinegar
  - Interior: 100% alkyd enamel, with gloss matching adjacent surfaces
  - Exterior: 100% acrylic enamel, with gloss matching adjacent surfaces.
- 
- Exterior paintable surfaces: (semi-gloss enamel shall have 50% - 60% gloss level).
    - Masonry: 100% Acrylic Flat
    - Stucco: 100% Acrylic Flat
    - Wood: 100% Acrylic Semi-Gloss
    - Metal doors, frames, pipes, and other trim: 100% Acrylic Semi-Gloss
    - All other exterior surfaces to be painted: 100% Acrylic Semi-Gloss
    - Do not use alkyd finishes on exterior surfaces

### **Part 3 - Execution**

- Specify required protection of adjacent surfaces, and removal/replacement of appurtenances.
- Require that product data and MSDS for each material being used are available on the site.
- Specify priming, painting, and finishing of all painted surfaces, covering in detail:
  - Required surface preparation (for all new and existing surfaces)
  - Application techniques
  - Drying times
  - Sanding
  - Recoating
  - Minimum number of coats
- Make reference and specify the techniques found in the PDCA manual for a "type 1 standard job".
- Include a requirement that each primer and finish coat be inspected through the University's inspection process prior to application of the succeeding coat, and that the color of each coat be slightly varied.

### **End of Section 09900**

## **DIVISION 9 - FINISHES**

### **Section 09950 - Wall Coverings**

#### **Introduction**

The use of wall coverings is not standard in University work and should be reviewed with the Project Coordinator. They shall not be used as a wainscot and should only be considered for aesthetic reasons in special purpose areas such as executive offices, conference rooms and lobby areas not subject to abuse. Papers, foils and flocks are not permitted.

#### **Part 1 - General**

- Tackable materials should be considered
- Cross reference this section with Corner guards, if used.

#### **Part 2 - Products**

- Vinyl materials shall be minimum 54 oz.
- Oil base primer or enamel undercoater shall be used to "size" the wall surface.
- Adhesive shall be manufactured or approved by the covering manufacturer.

#### **Part 3 - Execution**

- Install covering over abandoned outlet boxes. Fill openings if permanent.
- Only vertical joints are permitted.
- Doublecut joints with a straight edge.
- Pattern match, if critical, shall be mentioned in the specification and if necessary to rotate alternate sheets so same edge abuts same edge of roll, it should be so specified. to avoid gradations in match at seams.
- Manufacturers data sheets shall be provided and a minimum of 9 square yards of each color and type of wall covering used in the project shall be provided as extra stock.

#### **End of Section 09950**

## **DIVISION 10 - SPECIALTIES**

### **Section 10000 - General Discussion**

#### **Introduction**

The products specified in Division 10 are the pieces and parts that make up the finishing touches of a project. In many cases they make the room or spaces functional. High quality, serviceability, maintainability and extended product life are the needs upon which this Section is developed. In some cases qualitative standards are cited for an item(s) and in others, specific product names and manufacturers are cited. When the product or item is cited by name, it is the intention that the name/item(s) be incorporated into the project. In such cases the University maintain "in-house" expertise, parts and maintenance stock to service the item. Further, it is in the best interest of the University to have consistency if only from the standpoint of the sheer logistics of maintaining and supplying its many buildings.

The consultant should select from the range of products and review and coordinate with the Project Manager and Users to determine any special requirements or features for the project.

#### **Chalkboards, Markerboards, and Tackboards**

These items, as specified, conform to the University Classroom Design Standards. They are fairly standard and should be specified, sized, selected and customized based on User need and preferences.

#### **Toilet Partitions**

Metal toilet partitions are the product of choice for the University. These have proven to be the most vandal resistant, repairable and serviceable of all the products now in use on campus. However there are other applications where metal is ill-advised and may be subject to wet or *corrosive conditions* in excess of normal conditions such as locker rooms and pool areas. In such conditions *solid plastic panel partition systems* will be acceptable. Plastic laminate clad wood or particleboard shall not be specified or used.

#### **Corner Guards**

Corner guards are a practical solution to a major problem in high use public areas and corridors, in particular where cart and rolling traffic is present. The selected product should be carefully considered and attention to detailing at the tops (where a radius may meet a ceiling grid) and bottoms (where base materials may wrap or butt). Termination of wall coverings at corner guards should also be studied and detailed. Color of materials must also be considered for match or contrast with adjacent surfaces.

#### **Signage and Graphics**

Example of comprehensive signage package is incorporated into the Section. Room names and numbers as they appear on the drawings may not be the same as that used by the University for identification. This should be verified prior to submittal of shop drawings. A schedule showing all of the signs required, as well as the type together with location plan must be included. This comprehensive signage package must be included regardless of who provides the signage, be it the University or an outside vendor.

#### **Letters and Plaques**

Location of letters and building name shall be coordinated with the Project Manager. Recently, building identification has been accomplished with free standing signage. If letters are provided, size shall be at least 8". Style of letters shall be reviewed by Project Manager.

#### **Directories and Bulletin Boards**

Design should compliment the building. Size and location of directory and bulletin board should be coordinated with the User and the Project Manager. Adequate sizes shall be established to allow for building growth and sufficient sets of letters shall be provided with the units. Size of letters and tactile marking to comply with ADA requirements shall be considered by the Consultant. Units must be of vandal proof construction.

**Fire Protection Devices**

Fire extinguishers will be provided and installed as a part of the construction contract. Type shall be selected as appropriate for the class of equipment being served. Locations shall be shown on the drawings and coordinated with the University's Risk Management department.

**Toilet Accessories**

Occasionally requirements will vary depending upon whether the project is located on the Main Campus, AHSC, or within a Residence Life Facility. Verify with Project Manager of specifics.

**End of Section 10000**



## **DIVISION 10 - SPECIALTIES**

### **Section 10100 - Chalkboards, Markerboards and Tackboards**

These items should conform to the University Classroom Design Standards. The products are fairly standard and should be specified, sized, selected and/or customized based on the User's needs and preferences with the concurrence of the University Teaching Center.

#### **Part 1 - General**

- Markerboards are preferred over chalkboards primarily because of the problems associated with chalk dust. The University is gradually migrating in this direction but there may be instances where chalkboards are more desirable. Chalkboards should be avoided when an appreciable amount of computer and audio visual equipment is used in the area.
- Locations, mounting heights and sizes should be clearly shown on the drawings and elevations.

#### **Part 2 - Products**

- Chalkboards and markerboards (whether fixed or moveable) shall be of 3-ply construction consisting of a face sheet, core material and backing.
  - Face sheet shall be one piece 24 gauge porcelain enamel steel skin (magnetic) with appropriate fused surface for either chalkboards or dry erase markerboards. Surface for chalkboards shall be similar to "Vitracite" by Claridge with matte finish, color: Black only. Surface for markerboards shall be similar to "LCS" by Claridge with high gloss finish intended for use with liquid felt-tipped markers, color: White or Light Gray.
  - Core for fixed units shall be minimum 3/8" particle board or Duracore. Core for moveable units shall be minimum 3/8" heavy kraft paper honeycomb.
  - Backing for fixed units shall be aluminum foil. Backing for moveable units shall be 26 gauge galvanized steel sheet.
  - Accessories (fixed boards): Provide continuous extruded aluminum chalktray at bottom of board. Provide cork tack strip along top of board with sliding map clips every twelve inches.
  - Aluminum frame and accessories shall be clear anodized aluminum finish.
- Moveable units should be manually operated, vertical sliding, multiple 2 or 3 tack, counterbalanced with shielded ball bearing pulleys and aircraft cable supporting wires. Horizontal sliding units should be avoided. Operation should be easy and quiet with no rattling of panel within the track. Provide units with integral continuous chalktray. Motorized vertical units may be considered depending on the application with the approval of FM.
- Vertical sliding units may either be surface mounted or floor mounted with a kick panel. In either case the back fixed surface should be utilized as a similar writing surface or a projection surface. Bare walls behind the vertical sliding units should be avoided. Kick panel surface should be specified to compliment the adjacent finishes.
- Any individual unit should not be larger than 16 feet long.
- Tackboards should be natural cork product combined with linseed oil laminated on a burlap backing with natural pigments that go through to the backing. Preferred color is tan. Product shall be self healing, soil resistant, washable, have a low light reflectance and not contain any toxins or harmful emissions. Minimum thickness of cork should be 1/4". Boards may be additionally mounted on hardboard backing for rigidity.

### **Part 3 - Execution**

- If a projection surface is intended behind vertical sliding units, care must be exercised to insure that the height of the markerboard are sufficient to serve this purpose. A general rule is that the top of the screen surface should be no less than the centerline of the projector lens.
- Provide the maximum manufacturer's available guarantee.

**End of Section 10100**

## **DIVISION 10 - SPECIALTIES**

### **Section 10155 – Solid Plastic Toilet Compartments**

#### **Introduction**

Toilet compartments are subject to considerable use, damage and vandalism. Consequently they need to be given attention to insure that they will withstand this abuse and not present a maintenance burden.

*Wood and wood laminate partitions are not to be used.*

#### **Part 1 - General**

- Toilet compartments are subject to vandalism and therefore must be adequately braced and constructed of material that is not easily defaced or deformed.

#### **Part 2 - Products**

- Toilet partitions, compartments, doors and screens should be constructed of standard fabricated *high density polyethylene* or solid *phenolic* panels. Customized shapes and configurations should be avoided.
- Partition supports and pilasters should at least be specified for floor and wall attachment. Additionally attach to ceiling bracing if possible. Partitions which are attached only to the ceiling and walls must be avoided. Provide anti-grip type overhead braces over door openings.
- Pilaster shoes and caps should be attached with manufactured clips.
- All fasteners and assembly screws shall be tamper proof. Partitions shall be attached to the wall with no less than three brackets. Brackets shall be secured with no less than two fasteners.
- All hardware shall be heavy duty institutional type. Door hinges shall be adjustable self closing.
- Doors on HC stalls shall be out-swinging. Doors on regular stalls shall be in-swinging. Provide pulls on both sides of out-swinging doors to handicap stalls.
- Screens shall be attached with wall brackets and a front supporting post secured to the floor to provide additional resistance from lateral impact.

#### **Part 3 - Execution**

- Adjust hinges so that both in-swinging and HC out-swinging doors remain open at a 30 degree angle when unlatched. All partitions, compartments and doors shall be installed so all edges are plumb, level and parallel. Protect during construction and clean prior to acceptance.

#### **End of Section 10155**

## **DIVISION 10 - SPECIALTIES**

### **Section 10160 - Toilet Compartments**

#### **Introduction**

Toilet compartments are subject to considerable use, damage and vandalism. Consequently they need to be given considerable attention to insure that they will withstand this abuse and not present a constant maintenance burden.

Wood and wood laminate partitions are not to be used.

#### **Part 1 - General**

- Toilet compartments are subject to vandalism and therefore must be adequately braced and constructed of material that is not easily defaced or deformed.

#### **Part 2 - Products**

- Toilet partitions, compartments, doors and screens should be constructed of standard fabricated hollow metal, *high density polyethylene or solid phenolic panels*. Customized shapes and configurations should be avoided.
- Metal panels are best fabricated from heavy gauge brushed stainless steel as it the most resistant to defacing and easiest to clean and maintain. Painted or enameled metal panels are discouraged as they are easily defaced.
- Partition supports and pilasters should at least be specified for floor and wall attachment. Additionally attach to ceiling bracing if possible. Partitions which are attached only to the ceiling and walls must be avoided. Provide anti-grip type overhead braces over door openings.
- Pilaster shoes and caps should be attached with manufactured clips.
- All fasteners and assembly screws shall be tamper proof. Partitions shall be attached to wall with no less than three brackets. Brackets shall be secured with no less than two fasteners.
- All hardware shall be heavy duty institutional type. Door hinges shall be adjustable self closing.
- Doors on HC stalls shall be out-swinging. Doors on regular stalls shall be in-swinging. Provide pulls on both sides of out-swinging doors to handicap stalls.
- Screens shall be attached with wall brackets and a front supporting post secured to the floor to provide additional resistance from lateral impact.

#### **Part 3 - Execution**

- Adjust hinges so that both in-swinging and HC out-swinging doors remain open at a 30 degree angle when unlatched. All partitions, compartments and doors shall be installed so all edges are plumb, level and parallel. Protect during construction and clean prior to acceptance.

#### **End of Section 10160**

## **DIVISION 10 - SPECIALTIES**

### **Section 10260 - Wall and Corner Guards**

#### **Introduction**

Corner guards are a practical solution to a major problem in high use public areas and corridors. The selected design should be carefully considered and attention to detailing at the top (where a radius may meet a ceiling grid) and bottom (where base materials may wrap or butt) must be studied. Corner guards should never terminate part way up a wall. Termination of wall coverings at corner guards should also be studied and detailed.

#### **Part 1 - General**

- Color of materials must be considered for match or contrast with adjacent surfaces.

#### **Part 2 - Products**

- Generally a heavy gauge brushed stainless steel corner guard with rounded corners is preferred.
- Heavy duty textured snap-in PVC materials on an aluminum retainer may be considered where color or a flush appearance is important.

#### **Part 3 - Execution**

- Manufacturers installation literature shall be followed with sufficient backup provided for support.
- Care shall be taken not to void fire ratings of walls.

**End of Section 10260**

## **DIVISION 10 - SPECIALTIES**

### **Section 10293 – Bird Control**

#### **Introduction**

Pigeon roosting and congregation is an ongoing problem at the University. Specify appropriate bird control systems whenever conditions are created that might enable pigeon roosting or congregation over occupied or pedestrian areas or where resultant roosting will create unsightly conditions. Areas where food service is available may need extra special attention.

#### **Part 1 - General**

- Generally, ledges, window sills, overhanging shade devices, roof peaks and edge conditions should be evaluated for application.
- For small isolated areas, parapet walls and roof edges, a stainless steel bird spike system may be sufficient.

#### **Part 2 – Products**

- For larger overhangs or window sills or where deterrence has been identified as a special requirement, a low voltage electric system such as the Avian Averting System® by Avian Flyaway, Inc is recommended. Contact information is as follows:

Avian Flyaway, Inc.  
Western Regional Office  
1645 W. Valencia Rd.  
Suite 109-514  
Tucson, AZ 85746  
Phone: (520) 889-7303  
Fax: (520) 889-1375  
<http://www.avianflyawayinc.com/>

#### **Part 3 – Execution**

- No discussion

**End of Section 10293**

## **DIVISION 10 - SPECIALTIES**

### **Section 10410 - Directories and Bulletin Boards**

#### **Introduction**

Design should compliment the building. Size and location of directory and bulletin boards should be coordinated with the User and the Project Manager.

Adequate sizes shall be established to allow for building growth and sufficient sets of letters shall be provided with the units. Size of letters and tactile marking to comply with ADA requirements shall be considered.

#### **Part 1 - General**

- Units shall be vandal proof construction

#### **Part 2 - Products**

- There are no unique University requirements.

#### **Part 3 - Execution**

- Mounting shall be concealed and vandal proof.

#### **End of Section 10410**

## **DIVISION 10 - SPECIALTIES**

### **Section 10420 - Dedication Plaque**

#### **Introduction**

A cast metal dedication plaque is required by Board of Regent policy on all projects in which the construction cost exceeds \$2.0 million.

The dedication plaque shall be furnished and installed as part of the construction project.

#### **Part 1 - General**

- Plaque shall be identified on the drawings and located near the building entrance, just inside or outside of the main entry doors. For building additions, the location of the new plaque shall not conflict with or replace the location of the existing plaque(s).
- University of Arizona DSS Detail 10420-D1 shall be used to provide a dimensioned elevation view and details of the plaque in the project specification. No deviations from this standard will be allowed for new buildings. For building additions endeavor to match the details of the existing original plaque(s).
- Text for plaque shall be furnished by the University and adhere to the following traditions:
  - The date of erection shall be the year in which the construction effort was complete.
  - The names of the Governor, members of the Board of Regents and President of the University are those that held office at the time the construction contract was awarded.
  - The above information as well as the name of the building shall be verified in writing with the University of Arizona President's Office.
  - The names of the Architect, Contractor and Construction Manager (if applicable) shall be the same as that contained in their respective contracts and limited to one line each.
  - Exact text for plaque will typically not be available at the time the project is bid. Consequently, for bidding purposes, only an example of the text can be provided or an allowance of 400 letters established. Exact text shall be confirmed as part of the shop drawing review process.
- Required submittals from the manufacturer shall include technical product data, detailed shop drawings and a final full size rubbing of the mold prior to casting. Shop drawing submittal shall include an accurate scaled drawing of the plaque showing complete layout and size of text as well as large scale details of letters, border style and anchoring method.

#### **Part 2 - Products**

- Plaque shall be of cast metal bronze unless matching an existing original plaque. Background of plaque shall be manufacturer's standard pebble texture and oxidized. Text shall be flat faced Roman style font (flat face classic). Raised text and border shall be belt finished or milled to provide a uniform polished satin grain highlight.
- Fasteners or anchors shall be appropriate for exterior installations and be non-corrosive to either the sign material or mounting surface. Exposed fasteners shall be countersunk, utilize a security head and be concealed with a standard rosette. Border shall be U of A standard as detailed. (Custom Ogee.)
- Overall dimensions of plaque may vary slightly to accommodate variations in text but must be approved by the University during the shop drawing process.
- A durable clear coat protective finish shall be applied to the plaque after casting. Comply with NAAMM "Metal Finished Manual" for finish designations and criteria.



- One vendor that has been used for past University dedication plaques is A.R.K. Ramos. Their contact information is:

A.R.K. Ramos Signage Systems  
P.O. Box 26388  
Oklahoma City, OK. 73126

Phone 405-235-5505  
Toll Free 1-800-725-7266  
Website [www.arkramos.com](http://www.arkramos.com)

### **Part 3 - Execution**

- After installation clean and protect plaque until final acceptance by the University



## **DIVISION 10 - SPECIALTIES**

### **Section 10430 – Exterior Signs**

#### **Introduction**

All exterior signs shall comply with the University Identification Guide, Section II – Exterior Signage Guide.

#### **Part 1 - General**

- Compliance with the Exterior Sign Manual is to ensure the implementation of a comprehensive and consistent campus-wide exterior sign program including but not limited to: identification, directional, informational, and regulatory signs.
- Generally, projects that entail new facility construction, additions to existing facilities, facility renovations that involve change of use, site modifications, and other similar work will require new exterior signage or changes to existing exterior signage.
- Where exterior signage is required, it will be the responsibility of the project to include exterior signage in the Scope of work and the project budget.
- It shall be the responsibility of the Design Consultant in conjunction with the User to first identify and then document the extent, location, size, text, graphics, color, materials and other signage elements consistent with the criteria in the Exterior Sign Manual.
- It is recommended that signage development be initiated early in the design of the project.
- All Exterior Signage must be reviewed and approved by The University Sign Committee per the Sign Review Procedures detailed in the Exterior Signage Guide.
- Copies of the Exterior Signage Guide should be obtained and coordinated through the FDC Project Manager.
- In general, most exterior signage will be fabricated and installed by The University's Facilities Management shops following Sign Committee approval and processing the necessary Work Orders through Facilities Management. The FDC Project Manager should assist the Design Consultant in segregating and budgeting exterior signage that will be under the contract for construction versus via Work Orders to University personnel. The FDC Project Manager shall issue the Work Orders.

#### **Part 2 - Products**

- No discussion

#### **Part 3 – Execution**

- No discussion

#### **End of Section 10430**

## **DIVISION 10 - SPECIALTIES**

### **Section 10520 - Fire Protection Devices**

#### **Introduction**

Fire extinguishers shall be provided and installed as a part of the construction contract. Type shall be selected as appropriate for the class of equipment being served.

Locations shall be shown on the drawings.

#### **Part 1 - General**

- Cabinets shall be large enough to contain a 10# dry chemical type extinguisher. Coordinate wall thickness to insure adequate depth is provided.
- Mounting brackets shall be provided for extinguishers not located in cabinets.

#### **Part 2 - Products**

- Fire extinguishers shall generally be multi-purpose dry chemical type, UL rated, 4-A:60-B:C, 10lb nominal capacity, in enameled steel container for Class A, Class B and Class C fires.
- Fire extinguisher cabinets shall be either semi or fully recessed type with enameled steel box. Exposed trim, door material, door style and hardware shall be as selected by the Consultant and appropriate to the design of the building. Lobbies, public spaces, corridors and the like may have upgraded materials in keeping with the building design. In less public areas, polished, non-directional #4 stainless steel should be considered for door material.

#### **Part 3 - Execution**

- Securely fasten mountings to building.
- Cabinets shall be identified with lettering spelling "FIRE EXTINGUISHER".

#### **End of Section 10520**

## **DIVISION 10 - SPECIALTIES**

### **Section 10810 - Toilet Accessories**

#### **Introduction**

This section addresses the type of accessories which are to be provided or anticipated for all new and remodeled restrooms.

Requirements for toilet accessories may vary depending upon whether the project is located on the Main Campus, at AHSC or within a Residence Life Facility. All assumptions shall be verified with the Project Coordinator and the respective custodial group.

Facilities Management administrates annual contracts for the furnishing of paper towels, hand soap and toilet tissue. Consequently these respective dispensing elements are sometimes supplied by the vendor or FM Custodial Services.

Below are the requirements for toilets which will be serviced and maintained by Facilities Management.

#### **Part 1 - General**

- Provide at least one paper towel dispenser for every three sinks and install at HC accessible height.
- All dispensing units shall be surface mounted. Recessed elements are to be avoided. Stud walls should receive appropriate blocking to accommodate surface mount attachment.
- For new projects, FM Custodial Services will provide hand soap and toilet tissue dispensers for installation by the contractor. Paper towel dispensers are to be provided and installed by the contractor.
- Trash receptacles are to be located or at least anticipated in every restroom.
- Provide an Accessories Schedule in the specifications or on the drawings listing each room and the quantity of each type of accessory required as well as who provides what elements and who installs.
- Consultant should anticipate and prescribe locations of owner furnished elements so as to insure that conflicts with contract work do not exist.

#### **Part 2 - Products**

- Paper towel dispensers shall be surface mount, Georgia-Pacific Roll Towel Dispenser, model 54338, hands free push paddle, translucent smoke.
- Soap dispensers are provided by Custodial Services via their soap vendor and are surface mounted WAXIE "Nice Touch" stock #380143, white, with either adhesive backing or screw attachment. Avoid attaching to mirror.
- Toilet tissue dispensers are provided by Custodial Services via their paper vendor and are large diameter surface mounted covered spools, Jaric Jumbo Stainless Steel, stock #KD1000. Handicap accessible toilet stalls use side by side, surface mount WAXIE "Compact Coreless Tissue Dispenser", stock #537412, smoke gray.
- Sanitary napkin/tampon vendors shall be surface mounted and constructed of stainless steel. Capacity not less than 15 napkins and 20 tampons. Currency cost and coin slot for \$0.25. Brand name advertising not allowed. Provide Bobrick B-352 or equal.

- Sanitary napkin disposal units shall be surface mounted and constructed of stainless steel. Bobrick B-3544 or equal.
- Waste receptacles will be provided by Custodial Services as part of FFE and will be free standing units.
- Grab bars shall be stainless steel, 18 gauge minimum wall thickness, 1.5" minimum outside diameter with concealed mounting devices. Install to provide 1.5" clearance between wall and inside face of handrail.
- Mirrors shall be 1/4" glass with stainless steel frame and concealed fasteners. Locate and size mirror to provide adequate free wall space for soap dispenser.

### **Part 3 - Execution**

- Provide stud wall backing for all surface mounted accessories.
- Protect all toilet accessories from damage during the course of construction.
- Clean all surfaces in strict accordance with manufacturer's recommendations after removing temporary labels and protective coatings.
- Mount paper towel dispensers with lever at 48" A.F.F. for ADA accessibility.
- Layout all accessories to ensure that surface mount elements do not restrict access to sinks.

### **End of Section 10810**

## **DIVISION 11 - EQUIPMENT**

### **Section 11050 – Compact Shelving**

#### **Introduction**

Compact shelving format is to be established during programming and design phases with the affected University Department and the Design Professional.

#### **Part 1 - General**

- Compact shelving may be manually or electrically operated.

#### **Part 2 - Products**

- If the compact shelving is electrically operated, then the following criteria should be requested:
  - All electrical wiring and equipment shall comply with the current NEC, class 1 circuit, Article 725.
  - The class 1 circuit limited power shall be from the fused control box to the wiring on the load side of the control box.
  - Flexible cords and cables will be allowed if the class 1 circuit is totally in compliance with Article 400 & 725 of the current NEC. This class 1 circuit shall not include wiring to the light fixtures on or associated with the compact shelving. Cords shall be rated for service encountered.
  - All wiring and equipment shall be grounded and bonded according to Article 250 or the applicable article of the current NEC.
  - All wiring methods shall be installed according to Article 300 of the current NEC.
  - All electrical devices, materials and equipment shall be listed and approved by a University of Arizona approved testing laboratory and shall be used for it's approved listing and it's intended purpose. Motors shall be suitable for duty encountered and the motor controls shall be readily accessible. Laboratory listing and component listing shall be a performed by U.L., C.S.A., F.M., City of Los Angeles or other laboratory approved by the University of Arizona.
  - Light fixtures shall be wired with M/C cable or other approved means. This cable shall be no larger than 3/8" in size.
  - Motor protection shall comply with current NEC, Article 430.
  - Light fixtures shall be approved for feed-through application on their listing label or shall be installed with a junction box external to the fixture to accommodate feeding the next fixture. Ballasts shall be Magnatec, Advanced or other University of Arizona approved manufacturer.
  - Fixture shall have CR85, T-8, 4100K lamps and shall meet the EPA requirement for non-hazardous disposal.
  - All penetrations for cords, cables or the like shall have an approved bushing installed wherever the wiring method passes through any metal enclosure, pipe, channel, light fixture, etc. This applies at all ends of hollow metal channels also.

#### **Part 3 - Execution**

- If the compact shelving is electrically generated then the following should be requested:
  - All compact shelving wiring shall be inspected and approved by University of Arizona Facilities Design & Construction Department Inspectors.
  - The compact shelving representative shall meet with University Representatives prior to installing any electrical wiring, devices, or equipment, to review any changes or variations in the applicable code or University of Arizona Standards.

#### **End of Section 11050**

## **DIVISION 11 - EQUIPMENT**

### **Section 11132 - Projection Screens**

#### **Introduction**

Verify information with the University Teaching Center

Ceiling mounting is preferred to clear wall mounted items. Mounting shall be secure and durable. "S" or "J" hooks shall be closed.

Lecture hall screens shall be electrically operated and laid out so that motor is accessible and fire ratings of ceiling and wall surfaces are not interrupted. 110V switch is provided for operation at a wall location and 24V switch is required for operation at a lecturn.

Manual pull down screens shall be not less than 8' wide.

#### **Part 1 - General**

- Reference Division 16 if the screens are electrically operated

#### **Part 2 - Products**

- Front view projection screens shall be a matte white polyester viewing surface with 1.2 grain characteristics complying with FS GG-S-00172D(1) for type A screen surface. Screens shall be seamless construction, mildew resistant and comply with NFPA 701 for fire performance characteristics.
- Where video projection is provided in the room, a "tab tension" shall be provided (to provide a uniform surface across the surface of the screen).

#### **Part 3 - Execution**

- There are no unique University requirements.

#### **End of Section 11132**



## **DIVISION 12 - FURNISHINGS**

### **Section 12000 - General Discussion**

#### **Introduction**

This General Discussion Section contains material which is important to the successful fabrication and/or installation of furnishings and equipment in construction projects. The issues are fundamental to the basic design of the project, and the long term success of those elements of the project., as well as the fabrication and installation process.

The consultant is expressly responsible for incorporating these overall requirements into the project, and for insuring that all the sub consultants are aware of the requirements and incorporate them into their designs as well.

#### **Furniture**

Items available through the Tri-University Purchasing Agreement are purchased by that means. Other items are bid through the Purchasing Dept. in compliance with the University Procurement Code. Furnishings are not usually a part of the building construction contract.

**End of Section 12000**

## DIVISION 12 - FURNISHINGS

### Section 12345 - Laboratory Casework

#### Introduction

These Standards differentiate between Laboratory Casework and Architectural Woodwork / Custom Casework because of the specialized nature and use of the product. Architectural Woodwork / Custom Casework Shall be specified separately in **Division 6 Wood and Plastics**.

Because the University anticipates a longer than average building life and higher than average use and abuse, durable, high quality Laboratory Casework is essential to the long term success and serviceability of any project. Section 12000 - Laboratory Casework specifies current Standards of the American Woodworking Institute (AWI) but modifies the standard to omit the use of certain materials in certain conditions and in certain portions of the work. Although used extensively industry wide, in the experience of the University, these materials have proven unsatisfactory and must be specifically excluded from the specifications. Specific pre-approved fabricators and/or manufacturers are listed, who, in the experience of the University, provide the necessary quality of work. Other fabricators/ manufacturers may be used through the pre-approval process.

#### Part 1 - General

- Laboratory Casework shall be fabricated to current standards of the American Woodworking Institute (AWI) and within the guidelines of the Scientific Apparatus Manufacturers Association (SAMA). Specific project requirements will determine the need for acid and chemical resistant acrylic, chemical resistant solid phenolic plastic, acid resistant plastic laminate, or standard plastic laminate counter tops.
- Indicate requirements for utility provisions which must be coordinated by the fabricator.
- Reference appropriate sections for Laboratory Tops and Equipment. (See Tab C3 Laboratory Planning and Design Criteria.)

#### Part 2 - Products

- All Laboratory Casework shall be "Custom" grade according to the American Woodwork Institute (AWI) and subject to the following:
- No particle board or particle board core plywood may be used in any part of the work (including laminate tops) and shall be specifically excluded. Plywood shall be industrial quality.
- Casework shall be opaque or transparent finish rotary cut uniform color light birch hardwood (unless otherwise approved by the Project Manager). Architect shall specify finish and call for sample submittal for review and approval. Interior of millwork shall receive opaque or transparent finish to match exterior.
- Pre-approved fabricators and manufacturers of **Laboratory Casework** are:
  - Atkinson's Cabinet Shop, (520) 792-4775
  - ISEC, Inc., (602) 926-1667
  - Carreto Custom Cabinet, (520) 624-3733
  - Sierra Woodworks, (520) 881-0222
  - Showcase Custom Cabinetry, Inc.,
  - Turnkey Corporation, (520) 571-8819
  - Creative Cabinets, (520) 624-3202
  - Collegedale, (423) 238-8113
- The lists in this section are non-exclusionary and not intended to be a comprehensive list of qualified fabricators and manufacturers. These lists are intended to identify Fabricators and manufacturers that have met the design and specification standards that are identified in this Section. Other fabricators and

manufacturers that can meet the design and specification standards in this Section may be considered.

- The pre-approved manufacturer of solid phenolic plastic lab tops is: **Pionite**.
- Minimum grades for plastic laminates shall be as follows (NEMA / ISO / Inch Thickness). For horizontal surfaces use HW62/HCS/.062" or GP50/HGS/.050" and for vertical surfaces use BK50/BGS/.050". Do not specify post forming grades of Laminates.
- Approved manufacturers of plastic laminate are:
  - Wilson Art
  - Formica
  - Nevamar
  - Pionite
- Hardware shall be indicated in a schedule in this section or in Section 08710, Finish Hardware. If in Section 08710, reference to that section.
- Drawer glides shall be full extension Heavy duty rated.
- Hinges shall be concealed type full metal with no plastic parts, 180° degree opening capacity.
- Hardware for adjustable shelves in cabinet bodies shall be K-V adjustable track with metal shelf support.
- Hardware for adjustable shelves on walls shall be heavy duty type equal to the K-V standard and bracket system.
- Approved hardware manufacturers are:
  - McKinney
  - K&V
  - Blum
  - Stanley
  - Gras

### **Part 3 - Execution**

- Fabricate case bodies with stop dadoes if transparent finish.
- All "Custom" grade Casework concealed surfaces shall be treated at the shop with spray or brush application of 50% Pentachlorophenol solution in a 1:10 mixture with deodorized spray base. In the field all concealed scribed and cut surfaces shall receive a brush application of the same material.
- Drawers shall be lock shouldered or multiple dovetailed and have applied fronts. Bodies shall be hardwood or 7 ply plywood. Bottoms shall be hardwood panel product or masonite hardboard full or stop dadoed. Exposed surfaces shall be hardwood. All drawers shall ride on full extension, full suspension drawer glides.
- Plastic laminate application shall be specified as follows:
  - Apply side edging first, then top surface, with top surface overlapping side edging.
- Installations shall be by skilled tradesmen. In the cases where fabricator and installer are not one and the same, product and project guarantee shall not be compromised.

### **End of Section 12345**

## **DIVISION 12 - FURNISHINGS**

### **Section 12510 - Blinds**

#### **Introduction**

Window blinds may be a part of the construction contract (preferable if there is no furniture contract) or a part of the FF&E budget. Check with the University Project Coordinator to see what method is appropriate.

Details should provide for proper attachment with backing as required for the attachment. If blinds will sit in front of windows, insure that they will clear furnishings. If blinds sit within window recess, make certain depth of recess is adequate for proper installation.

Vertical or horizontal blinds may be at the discretion of the Design Consultant. (Users occasionally have preferences.) Overall building appearance should be considered and if a standard has been established, that standard should be maintained so exterior appearance is consistent. Generally, vertical blinds do not retain dust and horizontal blinds do. Mini-blinds are preferred if horizontal and in either case, metal is preferred.

Specifically indicate on the plans the locations of the blinds.

#### **Part 1 - General**

- There are no unique University requirements.

#### **Part 2 - Products**

- There are no unique University requirements.

#### **Part 3 - Execution**

- There are no unique University requirements.

#### **End of Section 12510**

## **DIVISION 12 - FURNISHINGS**

### **Section 12690 - Floor Mats and Frames**

#### **Introduction**

Recessed floor mats must be provided at building entrances. Exterior installations are preferred.

#### **Part 1 - General**

- Require submittal of appropriate samples for approval and review of colors if applicable.

#### **Part 2 - Products**

- Frames shall be recessed and of aluminum, bronze, or other material complimentary to the building design.
- Metal foot grille type shall be specified. Size of panels shall be such that they are easily removed for cleaning. Joints shall divide the units into equal sections and material pattern in each section shall align with the adjacent sections.

#### **Part 3 - Execution**

- Comply with manufacturers instructions and coordinate top of mat surfaces with doors so that swing across mats provides under door clearance.

**End of Section 12690**

## **DIVISION 12 - FURNISHINGS**

### **Section 12710 - Fixed Seating**

#### **Introduction**

No discussion.

#### **Part 1 - General**

- Seating Layout: Design and install seating to optimize sight lines and space utilization. Comply with ADA Rules and Regulations. Architect shall provide initial layout and plans in a diagrammatic form showing number of seats, minimum aisle widths, H.C. seating spaces and armrest locations, aisle lighting and other requirements.
- Specify single-source responsibilities. Obtain seating, accessories, mounting components, including installation and coordination responsibilities from a single manufacturer.

#### **Part 2 - Products**

- Lecture Hall and Auditorium Seating:
  - Floor mounted fully padded, fabric covered seats with molded plastic backs and heavy gauge steel seat frame and pan. Provide self rising mechanisms. Do not use rail mounted systems.
  - Lecture Hall seating shall have folding tablet arms with nominal plastic laminate writing surface on hardwood plywood core, with rounded edges. Provide 13% of tablet arms for left-handers located on aisle seats.
- Arena Seating:
  - Riser mounted molded plastic with and without fabric covered padded seats (as required by the building program). Standards shall be cast iron.
- All seats shall be provided with Manufacturer's standard number and letter plates after determining seat/row designations with the University.
- Acceptable Manufacturers:
  - American Seating Col.
  - Hussey Mfg. Co.
  - Irwin

#### **Part 3 - Execution**

- Comply with recommendations of seating manufacturer for secure and proper installation.
- Install chairs using manufacturer's recommended hardware and fasteners. Chairs in curved rows shall be installed at smooth radius.
- Mounting bolts and assembly hardware shall be cut, capped and/or otherwise finished to achieve both a finished appearance to the installation and eliminate protrusions and sharp edges which could cut and tear.

#### **End of Section 12710**

## **DIVISION 14 - CONVEYING SYSTEMS**

### **Section 14000 - General Discussion**

#### **Introduction**

The size, number, and location of elevators must be addressed at the earliest stages of the design, to ensure that neither the overall function of the facility nor the optimum configuration of elevators is compromised. The size and location of the machine room is similarly critical.

Provide a minimum elevator machine room size of 100 square feet, exclusive of the area above the hoistway (for traction elevators), and without any odd corners, narrow passages or structural interferences.

Consultant shall design elevators to comply with current ASME A117.1, ASME A117.2, UBC and NEC codes.

When new elevators are being installed into existing buildings where elevators do not currently exist (as opposed to elevator modernization) comply with the criteria for new elevators to the most practical degree (extent) possible.

The Consultant is expressly responsible for incorporating these overall requirements into the project, and for ensuring that all sub-consultants are aware of the requirements and incorporate them into their designs as well.

Reliance on "after-the-fact" equipment selections to compensate for a problematic design decision is unacceptable.

Consultant is encouraged to develop the basic building design so that stairs are the naturally preferred mode of vertical travel.

Service elevators shall be located near the loading dock.

#### **Basic Elevator Selection**

Hydraulic elevators are generally used in low-rise buildings with two to three floors. Electric traction elevators are generally used in buildings over three stories. Consultant shall coordinate the electrical requirements as well as the code requirements for the pit, overhead clearance, shaft ventilation, pit ladder, light (with switch adjacent to ladder) and electrical duplex 120 VAC outlet in pit, equipment room and phone in cab.

In addition to this general discussion section refer to the following applicable sections:

- Section 14210 – Electric Traction Elevators
- Section 14240 – Hydraulic Elevators
- Section 14440 – Stair Lifts
- Section 16175- Elevator Power and Controls

#### **Fire Alarms and Protection**

Provide fire sprinkler heads in elevator shafts and machine rooms, when required by NFPA.

Provide smoke/heat detectors in elevator shafts and machine rooms when required by NFPA.

In addition, provide heat detectors with in 24 inches of each sprinkler head in the elevator shafts and in the machine rooms, which are connected to a shunt trip circuit, which in turn will shut off elevator equipment power prior to the discharge of water from the sprinkler system.

## University Checklist

The following checklist is used by the University when reviewing elevator drawings and specifications. The Consultant is encouraged to review this against his specifications to insure completeness at the time of submittal.

Motion Control Engineering Controls	Motion control performance
Modem and connections	ADA phone and make connections
Shunt trip breaker w/ heat detector	GFI breakers on 120 V. circuits, M/R and hoistway
Sump pump in elevator pit	Run phone wires for emergency phone and modem
Fire Service	Vent and cool M/R
Mount controller on M/R wall to prevent vibration	Lockable car light switch in M/R
Oil return pump	Submersible pump on hydraulic pump units
Pit depth	Duplex receptacle in pit
Pit stop switch next to ladder	Pit ladder
Sump pump in pit	Pit light switch next to ladder
Vent hoistway (unobstructed)	Hoist way overhead clearance
Paint fascia	PVC casing around jack assembly
Car control station shall be hinged and swing for easy access	Emergency light located in car control station
Hall lanterns (directional arrows)	Car position indicator
All fixtures illuminated by LED's	Hall position indicator at main lobby only
Stop switch keyed to EPCO-1	Tamper resistant fixtures by EPCO
Independent service keyed to EPCO-1	Meet ADA requirements (Braille & audible signals)
Smoke detectors to be compatible with and tie into building system	Light & fan switches keyed to EPCO-1
S.S. Handrails	Fire service switch keyed to MFD-1
Squirrel cage fan single speed	Provide emergency access in all hall hoist way doors
Photo curtain (Gatekeeper 2000 by Adams)	Provide protective cab blankets & hooks
Instruct University	Engrave bldg name and elevator # in car control panel
As-built drawing, parts list, instructions (in triplicate)	GAL door equipment
Key lock out to be mortised and accept Sargent & Medico cylinders	Nudging
Self-closing self-latch machine room Doors	Test equipment
	12 mo. warranty and maintenance w/24 hour coverage at no added cost
	Verify M/R access, slope ships ladder to be less than 60°
	Fire extinguisher in all machine rooms
	Elevator shutdown (shunt trip)
	Shunt trip control circuits monitored

- Ancillary electrical elevator equipment shall be fed from a separate, solely dedicated, elevator electrical LOAD CENTER. This elevator load center shall only be used for elevator related equipment and devices. It will provide the required means to lockout the equipment for service. Required characteristics of elevator electrical Load center are: surface mounted, copper bus, no door, dead front, 14 inches wide, lockable (lockout) breakers and a maximum size of 12 full size breaker spaces. Additional spaces are authorized only where the number of elevator related loads increases above 12 spaces. Unused breaker spaces shall not have any spare breakers installed. Ancillary elevator equipment to be fed from this panel may be, but is not limited to, the following:

- Shunt trip control feed
- Machine room lights/receptacles
- Elevator car lights
- Elevator pit lights/GFI receptacle
- Elevator pit sump pump
- Machine room A/C
- Elevator Fan (A/C)
- Hydraulic oil cooler



- Main electrical elevator feed should employ a molded case shunt trip breaker and a suitably sized enclosure. Larger enclosures for electronic type breakers are to be avoided as they take up too much room in an already cramped service space. Requirements for electrical coordination to be accomplished upstream of the main elevator feed.

Refer to attached pages 14000-3 through 14000-7 for “Construction Guidelines For Elevators” and “Firefighters Service/Shutdown Requirements” presented by The Industrial Commission of Arizona.

**ICA/ADOSH-ELEVATOR SECTION – PHOENIX (602) 542-3313 TUCSON (520) 320-4236/4237)**



**CONSTRUCTION GUIDELINES FOR ELEVATORS**

**(Per ASME A17.1-2000' Safety Code)**

**HOISTWAY**

- 1) Rule 2.1.1.1: Provide fully enclosed hoistway as required. (seal all penetrations)
- 2) Rule 2.1.1.2.2(d): Glass shall be laminated and each piece visibly marked as per ANSI Z.97.1 or 16 CFR Part 1201. (windows are prohibited in hoistways)
- 3) Rule 2.1.4: Provide hoistway ventilation if more than three floors. The area of the vent shall not be less than 3 ½ % of the area of the hoistway or a minimum of 3 square feet per elevator.
- 4) Rule 2.1.6.2(b): Projections, ledges, or recesses more than 4 in. wide shall be beveled to 75 degrees.
- 5) Rule 2.8.1.2: Electrical or mechanical equipment not pertaining to the elevator is prohibited.
- 6) Rule 2.8.2.4: Pipes conveying gases, vapors, or liquid not pertaining to the elevator is prohibited.
- 7) Rule 2.8.2.3.1: Sprinkler protection branch lines shall supply sprinklers at not more than one floor. (heat detectors used for shunt-trip operation\* must be within 2 ft. radius of each sprinkler head)
- 8) Rule 2.27.3.2.1(c): Provide smoke detector at the top of the shaft when the hoistway is sprinkled.
- 9) R4-13-512: The clearance between the car and the hoistway enclosure shall not exceed 18 in.

**PIT**

- 1) Rule 2.8.2.4: Pipes conveying gases, vapors, or liquid not pertaining to elevators is prohibited.
- 2) Rule 2.8.2.3.1: Sprinkler protection branch lines shall supply sprinklers at not more than one floor. (heat detectors used for shunt-trip operation\* must be within a 2 ft. radius of each sprinkler head and are not required if the sprinkler head is within 24 inches of the pit floor)
- 3) Rule 2.2.2: Provide a drain or a sump w/sump pump and cover that is level to the floor. Either means shall have positive means to prevent water, gases, and odors from entering the hoistway
- 4) Rule 2.2.5: Provide a light ( 10 fc. min.) with guard, easily accessible light switch, and GFI receptacle.
- 5) Rule 2.8.2.3.4: If sprinkled; all electrical equipment in the pit, within 48 in. above the pit floor shall be (a) weatherproof (NEMA4); and (b) wiring identified for use in wet locations as req'd in NFPA 70.
- 6) Rule 2.2.4.2: Provide a ladder or separate pit door for access when required.
- 7) Rule 2.2.8: Provide a permanent means to access the underside of car if the distance from the pit floor to the underside of the plank channels or slings exceeds 83 inches.
- 8) N.E.C. 620.24: Provide separate branch circuit for hoistway pit lighting and GFI receptacle.

**MACHINE ROOM**

- 1) Rule 2.7.1: Machine rooms and machinery spaces shall have a fire-resistance rating not less than what is required for the hoistway enclosure.
- 2) Rule 2.7.3: Provide safe, permanent, and convenient access to machine room and machine spaces.
- 3) Rule 2.7.3.4.1(b): Access doors to machine rooms shall be self-closing and self-locking. (c): be provided with a spring-type lock to permit opening from the inside without a key.
- 4) Rule 2.7.4.1: Machine rooms shall have a clear headroom of not less than 7 ft.
- 5) Rule 2.27.3.2.1.(b): Smoke detector required.
- 6) Rule 2.7.5.1: Provide lighting ( 19 fc. min.) with bulb protection, light switch, and GFI receptacle.
- 7) N.E.C. 620.23: Provide separate branch circuit for machine room/ machinery space lighting and GFI receptacle.
- 8) Rule 2.7.5.2: Provide adequate ventilation to meet the manufacturers' specifications.

1-04

## **CONSTRUCTION GUIDELINES-PAGE 2**

(continued)

- 9) Rule 2.8.4: Air conditioning equipment shall not be located directly above elevator equipment or electrical equipment. Required condensation drains shall not be located directly above elevator equipment or electrical equipment and not connected directly to a sewer.
- 10) Rule 2.8.2.3: Only branch sprinkler lines permitted in the machine room. (heat detectors when used for shunt-trip operation\* must be within 2 ft. radius of each head)
- 11) Rule 2.8.2.5: Pipes containing liquid shall not be located above the elevator equipment.
- 12) N.E.C. 620.51(a): Provide single mainline disconnect lockable in the open position (when the elevator equipment areas are sprinkled- the disconnect shall have shunt-trip operation\*). Per N.E.C. 620-91(c): A hydraulic elevator provided with battery lowering requires an auxiliary contact in the mainline disconnect.
- 13) N.E.C. 620.22: Provide separate branch circuit for the car lights, and car-top GFI receptacle. The overcurrent protection device shall be located in the machine room.
- 14) N.E.C. 620.53: Provide single means of disconnect for car light source and must be lockable in the open position.
- 15) Rule 8.6.1.6.5: Provide Class A-B-C fire extinguisher (easily accessible).
- 16) Rule 2.8.1.1: All wiring must be enclosed in metal conduit (telephone, detectors, etc..).
- 17) Rule 2.8.1.2: Electrical or mechanical equipment not pertaining to the elevator is prohibited.
- 18) Rule 2.8.2.4: Pipes conveying gases, vapors, or liquid not pertaining to the elevator is prohibited.
- 19) Rule 8.9.1&2: Provide code data plate on the controller or mainline disconnect.
- 20) Rule 2.26.1.5.10(c): When provided, machine room inspection operation with open door circuits shall have a means of two-way communication between the interior of car and the machine room.

### **SECONDARY & OVERHEAD SPACES- (IF APPLICABLE)**

- 1) Rule 2.7.3.4.1(a): Requires access door (29.5" x 29.5" minimum).
- 2) Rule 2.7.5.1: Provide lighting ( 19 fc. min. ) with bulb protection, light switch, and GFI receptacle.
- 3) N.E.C. 620.23: Provide separate branch circuit for machine room/ machinery space lighting and receptacle.

### **CAR**

- 1) Rule 2.27.1.2: Provide means of two-way conversation to authorized personnel responsible for taking appropriate action (telephone).
- 2) Rule 2.14.1.8: Glass in cars must be laminated, permanently marked (each piece of glass), and meet ANSI Z97.1 or 16 CFR Part 1201.
- 3) Rule 2.14.1.5: An emergency exit electrical device shall be provided on the car-top exit cover.
- 4) Rule 2.14.1.7.1: Provide a handrail on all sides of the car-top when the distance from the car-top to the hoistway enclosure exceeds 12 inches.

### **GENERAL**

- 1) \*Rule 2.8.2.3.2: If sprinkled: Provide means to automatically disconnect the mainline power supply prior to the application of water from sprinklers located in the machine room or shaft. (re: Shunt-trip)
  - 2) Rule 2.27.3: Provide Firefighters' Emergency Operation for all automatic elevators.
  - 3) ALL ELEVATORS SHALL COMPLY WITH NFPA 72. ( smoke and heat detectors shall be connected to a fire alarm panel\*\*, give location, be monitored, have secondary power, etc...)
- \*\*THE FIRE ALARM PANEL SHALL NOT BE LOCATED IN THE ELEVATOR MACHINE ROOM.

THE ELEVATOR SECTION WILL **MANDATE** COMPLIANCE WITH THE ABOVE. PRIOR TO AN ELEVATOR INSPECTION ALL DEVICES MUST BE PRE-TESTED FOR CONFORMANCE TO THESE RULES. THIS WILL MINIMIZE DELAYS FOR A CERTIFICATE OF COMPLIANCE.

1-04

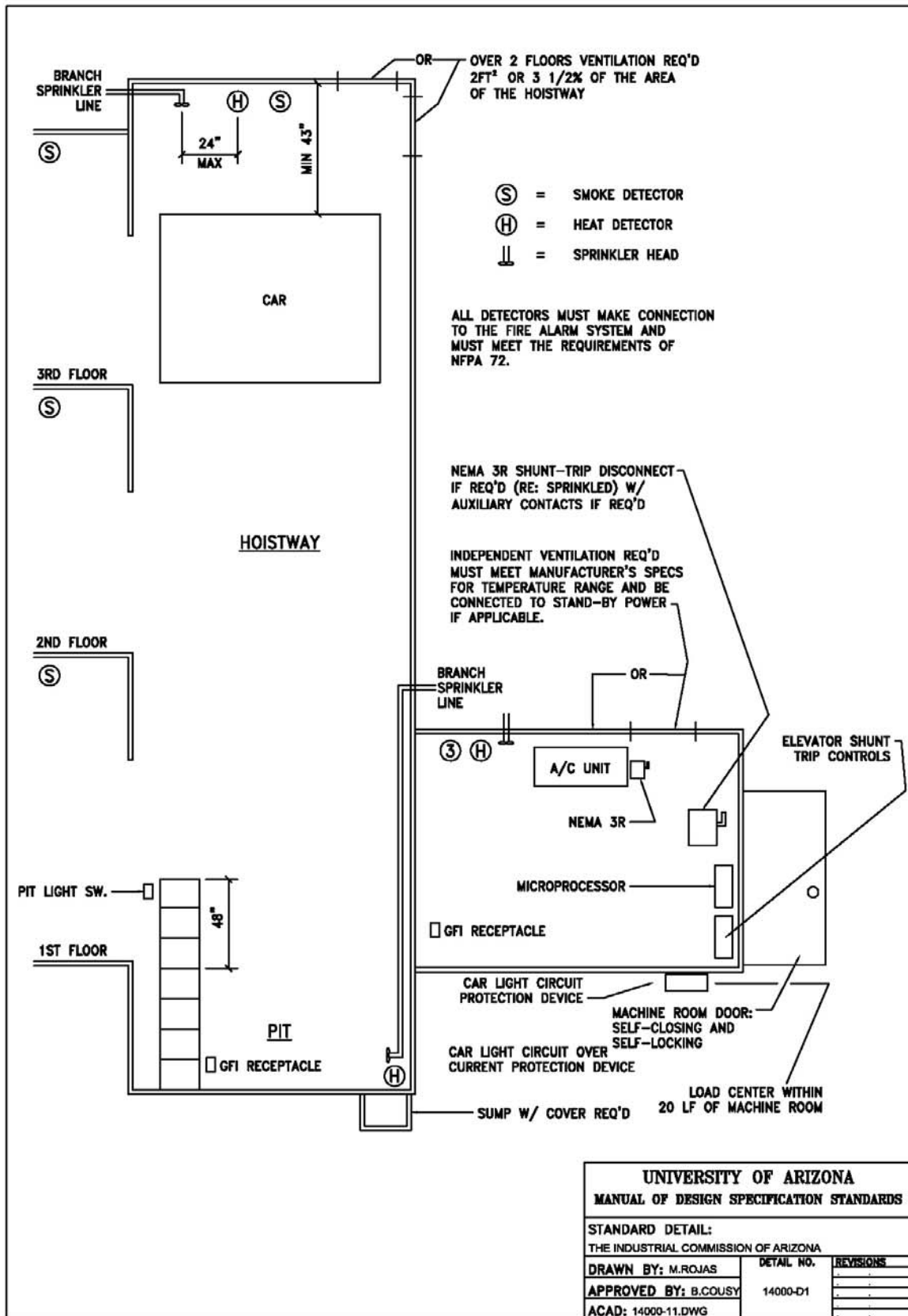

ICA/ADOSH-ELEVATOR SECTION – PHOENIX (602) 542-3313, TUCSON (520) 320-4236,4237



**ELEVATOR SECTION**  
**FIREFIGHTERS' SERVICE / ELEVATOR SHUTDOWN**  
**GENERAL REQUIREMENTS**

(Per ASME A17.1-2000' and NFPA 72-current edition)

**General Note:**

The following requirements are only a guideline for Firefighters' Service ("elevator recall") and Elevator Shutdown. See the above listed code books for complete requirements. These two operations are separate and work independently of each other. Smoke detectors are used to "recall" an elevator for Firefighters' Service (takes it out of normal service) and heat detectors are used for Elevator Shutdown (main power removal) via the "Shunt-Trip" disconnect.

**(A) Fire Alarm Panel requirements:**

- 1) The Fire Alarm Panel shall not be located in the elevator machine room.
- 2) The Fire Alarm Panel, or where required - "remote annunciator-fire alarm panel", must be located in an area where an alarm will be readily noticed. If that is not possible, the Fire Alarm Panel, wherever its building location, must be remotely monitored.
- 3) The Fire Alarm Panel and when required - "remote annunciator-fire alarm panel" must identify the type of device activated and its location. Example: "smoke detector - top of elevator shaft (hoistway)"

**(B) Detector requirements with no sprinklers in the hoistway or machine room:**

- 1) A smoke detector is required in the elevator machine room. Activation of this device shall recall the elevator to the alternate floor, unless the machine room is remotely located, and must cause the "Fire Hat" light in the elevator car station to flash.
- 2) Smoke detectors are required in all enclosed (not open to the outside) elevator lobbies. The detector at the designated (egress) floor level must recall the elevator to the alternate floor and all other lobby detectors must recall the elevator to the designated level.
- 3) No detectors are allowed in the hoistway.

**(C) Detector and other requirements with sprinkler in the machine room:**

Same requirements as **(B) plus:**

- 1) Heat detector(s) required and shall be located within 24 inches of each sprinkler head. Heat detector(s), when activated, must "Shunt-Trip" the mainline disconnect before the activation of the any sprinkler head.
- 2) If at any time, the power source to operate "Shunt-Trip" is not present, the Fire Alarm Panel and required annunciator panels must indicate a supervisory signal for "loss of elevator shunt-trip power".
- 3) If the mainline disconnect in the machine room is manually turned "off" or its been Shunt-Tripped "off" from a heat detector activation, the Fire Alarm Panel must **NOT** indicate a supervisory signal for "loss of elevator shunt-trip power".

(1)

9-05

cont'd

**(D) Detector and other requirements with sprinkler at the top of the hoistway:**

Same requirements as **(B)** number 1) and 2) plus:

- 1) A smoke detector is required at the top of the hoistway. Activation of this device shall recall the elevator to the designated level and must cause the "Fire Hat" light in the elevator car station to flash.
- 2) A heat detector is required at the top of the hoistway within 24 inches of the sprinkler head. Activation of this device must "Shunt-Trip" the mainline disconnect prior to the activation of the sprinkler head.
- 3) All electrical equipment within 48 inches of the pit floor must be weatherproof and NEMA 4 rated (must provide protection from the water spray of a sprinkler head).

**(E) Detector and other requirements with sprinkler at the bottom of the hoistway:**

Same requirements as **(B)** number 1) and 2) plus:

- 1) A smoke detector is required at the top of the hoistway. Activation of this device shall recall the elevator to the designated level and must cause the "Fire Hat" light in the elevator car station to flash.
- 2) A heat detector is not required in the pit within 24 inches of the sprinkler head if the sprinkler head can be located within 24 inches of the pit floor. If the sprinkler head is over 24 inches above the pit floor, a heat detector will be required, and must meet the weatherproof NEMA 4 rating.
- 3) All electrical equipment within 48 inches of the pit floor must be weatherproof and NEMA 4 rated (must provide protection from the water spray of a sprinkler head).
- 4) A smoke detector is not advisable in the elevator pit (possibility for false alarms).

**(F) Firefighters' Service Indication requirements:**

- 1) Upon activation of any smoke detectors in any affected elevator spaces, or when the affected elevator Phase I Fire Service recall key switch is turned to the "on" position, an indicator light, on or at, the Phase I Fire Service recall key switch located at the designated level shall illuminate to indicate that the affected elevator(s) is on Firefighters' Service. Activation of any affected elevator lobby smoke detector shall illuminate the "Fire Hat" symbol located inside the elevator. Activation from a hoistway or machine room smoke detector shall illuminate a "flashing Fire Hat" symbol inside the elevator.

**(G) Hydraulic Elevator Auxiliary (battery) Lowering with a Shunt-Trip disconnect req's:**

- 1) An auxiliary contact on the mainline disconnect must be provided to disable the battery lowering function (elevator cannot move) if the mainline disconnect is manually turned "off" or if it has shunt-tripped "off". Battery lowering can only occur if the normal building power that feeds the mainline disconnect is not present.

**(H) Sprinkler Line general requirements:**

- 1) Only branch sprinkler lines are allowed in elevator spaces. Branch lines must terminate once they enter a space. Branch sprinkler lines entering the hoistway must enter only from the floor they are to serve. A branch sprinkler line that enters the hoistway at the first landing to sprinkle the pit, can only sprinkle the pit. The branch sprinkler line for the pit cannot extend up to sprinkle the top of the hoistway. That branch line must enter at the top landing. Branch sprinkler lines entering the hoistway at the top floor to sprinkle the top of the hoistway may not extend to other parts of the building. A branch sprinkler line entering the machine room shall only sprinkle the machine room, or it can be allowed to extend to the hoistway only if it will branch sprinkle at that level.

(2)

9-05

End of Section 14000

## **DIVISION 14 - CONVEYING SYSTEMS**

### **Section 14210 - Electric Traction Elevators**

#### **WORK INCLUDED**

- Installation of a new engineered TRACTION elevator complete as described in this standard.
- Elevator systems shall be engineered in accordance with the requirements within this document.

#### **SUBMITTALS**

- Submit bound operation and maintenance manuals for the new equipment (4 copies) with operating and maintenance instructions, parts listing, recommend parts inventory listing, purchase source, listing for critical component, emergency instructions, complete "as built" wiring and block diagrams including input signals, and diagnostic and/or trouble-shooting guide shall be furnished to the Owner.
- Submit a complete list of all items to be furnished and installed under this section. Included manufacturer's specifications, catalog cuts, and other data to demonstrate compliance with the specified requirements.
- Submit complete shop drawings for all work in this section, showing dimensions and locations of all items including supporting structure and clearances required.
- Manufacturer's recommended installation procedures which, when approved by the Owner, shall be the basis for inspecting and accepting or rejecting actual installation procedures used on the work.
- Submit one (1) complete clean set of drawing prints and specifications with "as-built" conditions marked in crisp red ink. Sign and attest to the documents as reflecting all conditions "as-built".
- Provide four (4) copies of Operation and Maintenance Manuals, Installation Manuals and Parts Manual necessary for full servicing of the elevator and microprocessor.
- Provide two (2) digital copies on "CD" of "AS-BUILT" wiring drawings.

#### **QUALITY ASSURANCE**

- Elevator installer is responsible for quality assurance and insuring that all systems related to the function of the elevator are complete and functioning properly.

#### **MAINTENANCE**

- Starting at the time of substantial completion of the complete project, provide complete systematic inspection and maintenance of the elevator for a period of 12 months. Furnish trained experts and equipment to check, adjust, lubricate, and otherwise maintain the elevator in operation with out defects or deterioration. Replace or repair materials and parts which become defective or deteriorated for any reason except through abuse or misuse by Owner.

#### **USE OF ELEVATOR**

- The elevator shall not be used temporarily for building construction purposes unless specifically allowed by the Owner.
- If the Contractor is allowed to use the elevator prior to Substantial Completion of the project, the warranty and service period shall not be comprised and shall begin when substantial completion is achieved.

## ENGINEERED TRACTION ELEVATOR

- **Acceptable elevator manufacturers are:**
  - Kone Elevator Company
  - Otis Elevator Company
  - Schindler Elevator Company
  - Thyssen Krupp
  - Southwest Elevator Company
  
- **Attributes** (Traction Elevator)
  - Capacity: TBD
  - Speed: TBD
  - Operation: Selective collective.
  - Control: Microprocessor based Motion Control Engineering iControl for AC motor drive.
  - Travel: TBD
  - Stops: TBD
  - Openings: TBD
  - Platform size: TBD
  - Clear inside car: TBD
  - Car Doors: TBD
  - Hoist way entrance: TBD
  - Hoist way entrance finish: TBD
  - Door Operation: *G.A.L. MOVFR System*
  - Signals: Illuminated car and hall operating buttons, illuminated by light emitting diodes. Tamper Proof. SUVIVOR PLUS by Elevator Products Corporation. (EPCO)
  - Provide emergency access in all hoist way entrances.
  - Photo curtain shall be model A850G7 Gatekeeper 2000 by Adams Elevator Equipment Co.
  - Car telephone shall be model no. A936P3-2 as manufactured by Adams Elevator Co.
  - Car Enclosure:
    - Control panel (hinged to swivel toward the wall for easy access) complete with the following:
      - Digital car position and direction indicator, illuminated with light emitting diodes.
      - Fan key switch (EPCO-1).
      - Emergency stop key switch (EPCO-1).
      - Independent service key switch (EPCO-1).
      - Inspection/access key switch (EPCO-2).
      - Fire-fighter service key switch (MFD-1).
      - Alarm bell push type switch.
      - Engraved capacity plate and elevator designation. Verify fabrication.
      - Light key switch (EPCO-1).
      - Emergency light located in car control panel.
      - Emergency light test button.
    - The car platform shall be provided with vinyl composition tile flooring. Color as selected by Owner.
    - All elevators that are subject to high material or equipment transport use or other extreme uses (i.e., heavy loading, wheeled carts, exterior opening) shall have aluminum diamond plate floors.
    - For elevators that open to the exterior of a building the area surrounding the elevator entrance should be sufficiently sloped away from the entrance to prevent water from entering into the elevator hoistway.
    - Suspended egg crate ceiling with baked enamel finish or aluminum frame.
    - Lighting: Cool white T-8 fluorescent lighting.
    - Handrails: Stainless Steel.



- Sill: Aluminum.
- Ventilation: Exhaust type, single speed squirrel cage, 300 CFM velocity exhaust Blower. Isolate blower from steel cab canopy with rubber grommets.
- Provide hooks and removable blanket for protection of cab interior.
- Transom: Stainless steel.
- For elevators with glass installed in the cab or hoistway each piece of glass shall be laminated glass conforming to ANSI Z97.1 or 16 CFR Part 1201 with respective markings on each piece of glass clearly and permanently visible after installation.
- Elevator shall have provisions for handicapped complying with the requirements of ANSI A117.1 and new ADAAG Guidelines.
- Furnish manufacturers standard 3 roller guide assemblies with spring tension and adjustable rollers. T-rails with all required mounting hardware required for mounting.

### ENVIRONMENTAL CONSIDERATIONS

- Ambient temperature: 32 F to 104 F (0 C to 40 C).
- Humidity: not over 95% humidity.

### OPERATION, EQUIPMENT AND FUNCTION

- **Controller:** Solid State Motion Control Engineering Model iControl AC Flux Vector Drive traction elevators.
  - **Controller**
  - The elevator controller shall be microprocessor based and designed specifically for elevator applications. Elevator and drive logic shall be implemented independently of safety functions.
  - Elevator logic shall be implemented on a single processor to facilitate tight coordination between subsystems and enhance reliability. The implementation shall utilize a real-time, multi-tasking operating system to allow the processor to simultaneously execute elevator control logic, drive control logic, operator interface logic, and communication support.
  - The elevator controller shall provide the ability to access significant memory capacity for configuration parameter storage, event recording, real-time diagnostics, and program execution.
  - The elevator controller shall have an independent safety system in order to implement safety features required by code. The safety system implementation shall utilize solid-state devices. No relays shall be used for safety logic. The safety subsystem shall incorporate a check redundant, dual-processor, dual-path, solid-state, ASME A17.1-2000 compliant implementation that meets CSA and CE standards.
  - The elevator controller shall be configured and packaged in such a way that external “jumpers” cannot be used (intentionally or unintentionally) while the elevator is running in any passenger mode of operation. Nonpassenger modes of operation shall be provided, along with means to bypass safety functionality, to allow inspection testing and other setup and/or troubleshooting operations.
  - The elevator control logic configuration shall be fully field programmable. Changes in number of floors, I/O configuration, drive setup, eligibility etc. shall not require the replacement/reprogramming of EEPROMs or other storage devices. Further, changes in the controller configuration shall be user adjustable in the field.
  - The elevator controller shall have extensive diagnostic capability. A built-in LCD display or equivalent shall allow access to major user functions and diagnostic features. The display shall be a multi-character, multi-line type with associated keypad to allow users to enter information. The display shall show data and menus in readily understood character format. No numeric, hexadecimal, or binary codes are acceptable.

- Dedicated indicators shall be provided in a conspicuous location on the elevator controller to indicate important system statuses, such as when the safety string is closed, when the door locks are closed, when the elevator is on Inspection/Access, etc. In addition, other special or error conditions detected by the main processor or safety subsystem shall be displayed.
- The elevator controller shall support an interface for communication and interaction via a separate application program running on a Windows PC. This application shall communicate with the controller and allow the user to access controller configuration parameters, view real-time elevator status information, initiate and facilitate setup and adjustment procedures, and provide advanced troubleshooting capabilities. The PC application shall be designed specifically for elevator applications and shall graphically and dynamically display information from the controller.
- A PC application shall provide facilities to manage elevator controller configuration parameters. The user shall be able to manage and manipulate parameters including:
  - Retrieve from the elevator controller and view/edit
  - Retrieve from the elevator controller and save to a file on the PC
  - Retrieve from the PC, view/edit, and download to the elevator controller
  - Manage separate configurations for multiple elevator controllers
- The user shall be able to select specific groups or subsets of parameters to send or retrieve from the elevator controller.
- A PC application display shall provide motor field (where applicable), armature and brake voltages, armature current, intended and actual car speeds and hoist machine RPM. The PC diagnostics and adjustment display shall include online context-sensitive parameter descriptions and help information for fault troubleshooting.
- The controller shall maintain an event log that records noteworthy events or faults. They shall be displayed in chronological order and time stamped for analysis or review. Data displayed shall include the type of event or fault, the date and time it occurred, and the position of the car and status of various flags at the time of the occurrence. The event log shall be able to be saved and reviewed offline via the PC application.
- Communication between the elevator controller and the PC application shall be via a standard 100 base T TCP/IP network connection. The elevator controller shall be compatible with standard networking equipment (cables, hubs, switches and routers etc.).
- A PC application and elevator controller shall support remote connection via the internet (if available). The elevator controller shall support up to four simultaneous PC connections (remote and/or local). A mechanism shall be provided to prevent the unauthorized alteration of elevator configuration parameters.
- A controller test switch shall be provided. In the test position, this switch shall enable independent operation of the elevator, with the door open function deactivated, for purposes of adjustment and testing. The elevator shall not respond to hall calls and shall not interfere with any other car in a duplex or group installation.
- Switches for controller inspection, enable, and up and down shall be provided to place the elevator on Inspection operation and allow the user to move the car from the machine room. The cartop inspection switch shall render the controller inspection switch inoperative.
- The elevator control and safety functions shall be part of an integrated system designed for ease of use, with diagnostics and parameter adjustments accessible through a common user interface.
- The brake supply shall be capable of providing at least four independently adjustable values of output voltage in order to provide smooth lifting, holding and releveling. These values shall be adjusted via computer parameters. Manual adjustment of resistor values shall not be required.

- The elevator controller shall provide auto-tuning of the brake control values.
- The controller shall provide logic to detect a failure of brake voltage to properly decay and relax a picked brake to hold/cooling position.
- The brake control system shall include circuitry to detect insufficient brake current. This failure shall cause the elevator to be removed from service at the next stop and remain out of service until the condition is corrected.
- For gearless applications, the drive control system shall use an optimized speed profile in a dual-nested-loop feedback system based on car position and speed. A speed feedback device (tachometer or encoder) shall permit continuous comparison of motor speed with the calculated speed profile to provide accurate control of acceleration and deceleration—right up to and including the final stop, regardless of direction of travel or load in the car. Drive subsystem control parameters shall be digitally adjustable through software and shall be stored in non-volatile FLASH memory.
- For DC applications, the system shall include precise closed-loop motor field control. The system shall regulate motor field current throughout the range of operation via current feedback from the motor field. The system shall provide motor field current sensing which shall shut down the elevator if insufficient motor field current is detected.
- The system shall provide adaptive gain parameters for optimum control of elevator speed throughout its travel.
- The system shall use a device to establish car position to an accuracy of 0.1875" (4.76 mm) or better, using a quadrature signal operating over the entire length of the hoistway.
- The system shall use an automatic two-way leveling device to control the leveling of the car to within 0.25" (6.35 mm) or better above or below the landing sill. Overtravel, undertravel, or rope stretch shall be compensated for and the car brought level to the landing.
- A system for pre-torquing the hoist motor shall be made available to ensure consistently smooth starts. An electronic load sensor shall be required to implement the pre-torquing feature.
- Pre-start sequencing shall be provided to safely energize the machine prior to the doors closing on a departing elevator, thus consistently improving floor-to-floor travel times.
- Door pre-opening as the car approaches a landing shall be field adjustable to begin a maximum of six inches from level-at-floor position.

#### **AC Flux Vector Drive**

- The control system shall utilize a flux vector AC drive.
- The flux vector drive shall be capable of producing full torque at zero speed and shall not require DC injection braking in order to control car deceleration.
- The drive shall be capable of controlling geared and gearless machines, induction and permanent magnet motors. The drive shall also work with different types of encoders such as incremental, sine/cosine, and Hiperface.
- The drive shall have built-in motor overload protection. External overload is not required.
- The drive shall have the capability of being adjusted or programmed to achieve the required motor voltage, current, and frequency to properly match the characteristics of the AC elevator hoist motor.
- The drive shall not create excessive audible noise from the elevator motor.

- The drive shall be heavy-duty, capable of delivering sufficient current required to accelerate the elevator to contract speed with rated load. The drive shall provide speed regulation appropriate to the motor type.
- For non-regenerative drives, means shall be provided to remove regenerated power from the drive DC power supply during dynamic braking. This power shall be dissipated in a resistor bank that is an integral part of the controller. Failure of the system to remove regenerated power shall cause the drive output to be removed from the hoist motor.
- A regenerative drive option (PowerBack) is available to return power to the AC line during dynamic braking. This system is very effective for higher horsepower (above 30HP) and gearless applications.
- A contactor shall be used to disconnect the hoist motor from the output of the drive unit each time the elevator stops. This contactor shall be monitored and the elevator shall not start again if the contactor has not returned to the de-energized position when the elevator stops.
- The controller shall provide stepless acceleration and deceleration and provide smooth operation at all speeds.
- For applications where the building power supply has a “Grounded Leg Delta” configuration, an isolation transformer should be used to minimize noise and prevent any damage to the drive during voltage fluctuations.

### **Monitoring**

- A PC-based system monitoring application shall be available. At a minimum, monitoring shall be capable of providing system status, car location and travel direction, operating mode, door operation indication, dispatching ETAs, and security status.
- The monitoring system shall be capable of remotely registering car and hall calls and of configuring hall call and car call restrictions in support of building security. The system shall be capable of implementing security overrides if required.
- The monitoring system shall be capable of enabling Swing, Sabbath, and Auto-stop modes of operation on the group control and of acknowledging emergency alarm activity on any car in the group.
- The monitoring system shall be capable of selecting group mode of operation including, Balanced, Lobby Peak, Demand Down, Demand Up, and Auto-mode (dynamic mode selection by group controller) when Operating Mode Configuration 1 is active on the group.
- The monitoring system shall be capable of setting the group to Flood Operation mode when such mode is supported by the group control.
- The monitoring system shall be capable of initiating recall of any car in the group to a selected floor and of controlling door operation of that car at the selected floor.

- **Reporting**

- A client/server based report collection and generation application shall be available. Based on historical data collected by the server, the report application shall provide, at a minimum, hall call performance, hall call analysis, traffic analysis, hall call log, car call log, event log, emergency log, maintenance log, and percent in service reports.

- Systems that require hook-up of external devices for trouble-shooting are not acceptable.
- Nudging: If the doors shall be prevented from closing for longer than a predetermined time, door nudging operation shall the doors to move at slow speed in the close direction and to be unresponsive to the photo curtain. A buzzer shall sound while nudging operation is active.

- Hall or car call registration and lamp acknowledgment shall be by means of a single wire per call besides the power busses. Systems that register the call with one wire and light the call acknowledgment lamp with a separate wire are not acceptable.
- Fireman's Phase I emergency recall operation, alternate level Phase I emergency recall operation, and Phase II emergency in-car operation shall be provided according to applicable local codes. Keyed (MFD-1)
- Independent service operation shall be provided such that the actuation of a key switch in the car operating panel will cancel any existing car calls, and hold the doors open at the landing. The car will then respond only to car calls and will ignore hall calls. Car and hoist way doors will only close by constant pressure on car call buttons or a door close button until the car starts to move. While on independent service, hall arrival lanterns or jamb mounted arrival lanterns and gongs shall be inoperative. Keyed (EPCO-1)
- Simplex selective collective automatic operation shall be provided for all single car installations. Operation of one or more car or hall call buttons shall cause the car to start and run automatically provided the hoist way door interlocks and car door contacts are closed. The car shall stop at the first car or hall call set for the direction of travel. Stops shall be made in the order in which the car or hall calls set for the direction of travel are reached, irrespective of the order in which they were registered. If only hall calls are set for the opposite direction of travel exist ahead of the car, the car shall proceed to the most distant hall call, reverse direction, and start collecting the calls. For multiple car installations use duplex, triplex, etc.
- A test switch shall be provided. In the "test" position, this switch shall allow independent operation of the elevator without the door open function for purposes of adjustment or testing the elevator. The elevator shall not respond to hall calls shall not interfere with the other car in a duplex installation.
- A timer shall be provided to limit the amount of time a car is held at a floor due to a defective hall call or car call including stuck push-buttons. Call demand at another floor shall cause the car to eventually ignore the defective call and continue to provide service in the building.
- **Door Equipment**
  - Heavy Duty *G.A.L. MOVFR Door Operating System* to include, G.A.L. door rollers, door hanger tracks(car and hall) door pick-up assemblies, gate switch, door lock's.
  - Provide emergency access in all hoist way doors.
  - All doors shall have 1-1/2 hr. label or other identification acceptable to governing authorities.
  - Provide adjustable nylon guide (by Nylube or Adams Elevator Equip. Co.).
  - Heavy-duty doors. Provide door skins on both sides of elevator doors.
- **Lobby Position Indicator**
  - Provide tamper resistant lobby position indicator on the ground level, illuminated by light emitting diodes. By Elevator Products Co. (EPCO)
- **Smoke Detectors**
  - Smoke and heat detectors shall be compatible and tie into building fire system. NOTE: Heat detectors for activation of shunt trip devices do not need to report to fire alarm system.
- **Hall Direction Indicator**
  - Up and down tamper resistant SURVIVOR PLUS as manufactured by Elevator Products Co. (EPCO). Direction indicators to be provided in the hall wall with a single chime or tone for up and double chime or tone for down direction and shall be illuminated by light emitting diode.

- **Photo Curtain**

- Photo Curtain: An electric, passenger sensing device of the photo curtain shall project across the entrance to prevent the car and hoist way doors from closing if a passenger or object interrupts the curtain.
- Nudging: If the doors are prevented from closing for longer than a predetermined time, door nudging operation shall cause the doors to move at a slow speed in the closed direction and to be unresponsive to the photo curtain. A buzzer shall sound while nudging operation is occurring.

- **Car Operating Station**

- Flush mounted operating panel shall be mounted in the car return panel and shall contain the devices required for the specified operation. The buttons and devices shall be of the easy readability type and the floor designation buttons shall become illuminated when pressed and shall stay illuminated until the floor call is answered. Provide continuous hinge on panel for easy access to internal components. Locate hinges on side of panel nearest wall of the elevator. The car operating shall contain the floor designations, and all the controls indicated.
  - Digital car position indicator, illuminated with light emitting diodes.
  - Fan key switch (EPCO-1)
  - Emergency stop key switch (EPCO-1).
  - Independent service key switch (EPCO-1).
  - Inspection/access key switch (EPCO-2)
  - Firefighter service key switch (MFD-1)
  - Alarm bell push type switch.
  - Light key switch (EPCO-1).
  - Engrave capacity and elevator designation.
  - Engrave " INSPECTION CERTIFICATE ON FILE AT FACILITIES MANAGEMENT "
  - Emergency light.
  - Emergency light test button.

- **Elevator Shutdown**

- Elevator power shall automatically shutdown prior to sprinkler activation. This is typically accomplished by the use of a shunt trip breaker activated by a heat detector.
- Heat detector to be located no more than 24" from any fire sprinkler head installed in elevator shaft or machine room
- Heat detector should also report to fire alarm system
- Conduit circuits to shut down elevator power shall be monitored and supervised by the Fire Alarm System.

## EXECUTION

- **Telecommunication Link**

- Install communication cable for controller modem not to exceed 24" from controller.
- Install communication cable for car phone not to exceed 24" from controller.

- **Adjust And Balance**

- Make necessary adjustments of equipment to ensure elevator operates smoothly and accurately.

- **Protection**

- Locate and protect movable equipment and controls in such a way that they can only be operated by authorized persons.

- **Inspections**

- Obtain and pay for inspections and permits and make sure test are as required by regulations of authorities. Conduct all tests and inspections in the presence of the Owner.
- Final inspection shall be after all new equipment is installed and operating correctly.
- Inspect installation in accordance with ANSI-A17.2
- Deliver test certificates and permits to Owner.

- **Operation And Maintenance**

- Instruct Owner's personnel in proper use, operations and daily maintenance of elevators.
- Training shall include operation of diagnostic microcomputer and servicing of elevator microprocessor.
- Make final check of each elevator operation, with Owner's personnel present and just prior to date of substantial completion. Determine that control systems and operating devices are functioning properly.
- Continuing Maintenance: Provide 1-year maintenance on elevators on an as-needed basis as part of standard 1-year warranty on new equipment and upgrades.
- Maintenance shall include systematic examination, adjustment and lubrication of new elevator equipment; replacement of seals, packing and valves to maintain required factor of safety; performance of maintenance work with out removing car during peak traffic periods and providing 24 hour emergency call back service during maintenance period, at on additional cost to Owner.
- Repair or replace electrical and mechanical parts of the new elevator equipment using only genuine standard parts produced by manufacturer of equipment concerned.
- Ensure that competent personnel handle maintenance service. Maintain and adequate stock of parts for replacement of emergency purposes, locally, and have qualified personnel available at such places to ensure the fulfillment of this service without unreasonable loss of time.

- **Cleaning**

- Remove all trash and debris from site during elevator installation.
- Clean all elevator surfaces, removing all dirt, dust, spots, and scratches. Any damage shall be repaired or replaced as directed by Owner, at no cost to Owner.
- Prior to substantial completion, remove protection from finished or ornamental surfaces and clean and polish surfaces with due regard to type of material.
- Remove tools, equipment and surplus materials from site.

**End of Section 14210**

## **DIVISION 14 - CONVEYING SYSTEMS**

### **Section 14240 - Hydraulic Elevators**

#### **WORK INCLUDED**

- Installation of a new engineered HYDRAULIC elevator complete as described in this standard.
- Provide an engineered system in accordance with this document.

#### **SUBMITTALS**

- Submit bound operation and maintenance manuals for the new equipment (4 copies) with operating and maintenance instructions, parts listing, recommend parts inventory listing, purchase source, listing for critical component, emergency instructions, complete "as built" wiring and block diagrams including input signals, and diagnostic and/or trouble-shooting guide shall be furnished to the Owner.
- Submit a complete list of all items to be furnished and installed under this section. Included manufacturer's specifications, catalog cuts, and other data to demonstrate compliance with the specified requirements.
- Submit complete shop drawings for all work in this section, showing dimensions and locations of all items including supporting structure and clearances required.
- Manufacturer's recommended installation procedures which, when approved by the Owner, shall be the basis for inspecting and accepting or rejecting actual installation procedures used on the work.
- Submit one (1) complete clean set of drawing prints and specifications with "as-built" conditions marked in crisp red ink. Sign and attest to the documents as reflecting all conditions "as-built".
- Provide four (4) copies of Operation and Maintenance Manuals, Installation Manuals and Parts Manual necessary for full servicing of the elevator and microprocessor.
- Provide Two (2) Digital copies on "CD" "AS-BUILT" wiring drawings.

#### **QUALITY ASSURANCE**

- Elevator installer is responsible for quality assurance and insuring that all systems related to the elevator are complete and functioning properly.

#### **MAINTENANCE**

- Starting at the time of substantial completion of the complete project, provide complete systematic inspection and maintenance of the elevator for a period of 12 months. Furnish trained experts and equipment to check, adjust, lubricate, and otherwise maintain the elevator in operation without defects or deterioration. Replace or repair materials and parts which become defective or deteriorated for any reason except through abuse or misuse by Owner.

#### **USE OF ELEVATOR**

- The elevator shall not be used temporarily for building construction purposes unless specifically allowed by the Owner.
- If the Contractor is allowed to use the elevator prior to Substantial Completion of the project, the warranty and service period shall not be compromised and shall begin when substantial completion is achieved.



## ENGINEERED HYDRAULIC ELEVATOR

- **Acceptable elevator manufacturers are:**
  - Kone Elevator Company
  - Otis Elevator Company
  - Schindler Elevator Company
  - Thyssen Krupp
  - Southwest Elevator Company
  
- **Attributes** (Hydraulic Elevator):
  - Capacity: TBD
  - Speed: TBD
  - Operation: Selective Collective
  - Control: Microprocessor based, Motion Control Engineering HMC-1000 oilraulic controller.
  - Travel: TBD
  - Stops: TBD
  - Openings: TBD
  - Platform size: TBD
  - Clear inside car: TBD
  - Car Doors: TBD
  - Hoist way entrance: TBD
  - Hoist way entrance finish: TBD
  - Door Operation: G.A.L. MOVFR System
  - Signals: Illuminated car and hall operating buttons, illuminated by light emitting diodes.
  - Tamper Proof. SURVIVOR PLUS by Elevator Products Co. (EPCO)
  - Provide emergency access in all hoist way entrances.
  - Photo curtain shall be model A850G7 Gatekeeper 2000 by Adams Elevator Equipment Co.
  - Car telephone shall be model no. A936P3-2 as manufactured by Adams Elevator Co.
  - Car Enclosure
    - Control panel (hinged to swivel for easy access) complete with the following:
      - Digital car position and direction indicators, illuminated with light emitting diodes.
      - Fan key switch (EPCO-1).
      - Emergency stop key switch (EPCO-1).
      - Independent service key switch (EPCO-1).
      - Inspection/access key switch (EPCO-2).
      - Fire-fighter service key switch (MFD-1).
      - Alarm bell push type switch.
      - Engraved capacity plate and elevator designation. Verify fabrication.
      - Light key switch (EPCO-1).
      - Emergency light located in car control panel.
      - Emergency light test button.
    - The car platform shall be provided with vinyl composition tile flooring. Color as selected by Owner.
    - All elevators that are subject to high material or equipment transport use or other extreme uses (i.e., heavy loading, wheeled carts, exterior opening) shall have aluminum diamond plate.
    - For elevators that open to the exterior of a building the area surrounding the elevator entrance should be sufficiently sloped away from the entrance to prevent water from entering into the elevator hoistway.
    - Suspended egg crate ceiling with baked enamel finish frame.
    - Lighting: Cool white T8 fluorescent lighting.
    - Handrails: Stainless Steel.

- Sill: Aluminum.
  - Ventilation: Exhaust type, single speed squirrel cage, 300 CFM velocity exhaust blower. Isolate blower from steel cab canopy with rubber grommets.
  - Provide hooks and removable blanket for protection of cab interior.
  - Transom: Stainless Steel.
  - For elevators with glass installed in the cab or hoistway each piece of glass shall be laminated glass conforming to ANSI Z97.1 or 16 CFR Part 1201 with respective markings on each piece of glass clearly and permanently visible after installation.
- 
- Elevator shall have provisions for handicapped and complying with the requirements of ANSI A117.1 and ADAAG Guidelines.
  - Furnish manufacturers standard 3 roller guide assemblies with spring tension and adjustable rollers. T-rails with all required mounting hardware required for mounting.

### ENVIRONMENTAL CONSIDERATIONS

- Ambient temperature: 32 F to 104 F (0 C to 40 C).
- Humidity: not over 95% humidity.
- Vent machine room to outside to remove hydraulic fluid odors from building.

### OPERATION, EQUIPMENT AND FUNCTION

- **Controller:** Solid State Motion Control Engineering HMC-1000 for hydraulic elevators. Provide upgrade controller to be fully compatible with Owner's existing campus wide monitoring system. Mount controller to machine room wall to prevent vibration of solid state equipment. Dedicated permanent status indicators shall be provided on the controller to indicate the following: when the safety circuit is open, when the door locks are open, when the elevator is operating at high speed, when the elevator is on independent service, when the elevator is on fireman's service, when the elevator is out of service timer has elapsed or when the motor limit timer or valve timer has elapsed. In addition, provide means of displaying other special or error conditions that are detected by the microprocessor. The elevator shall not require the functioning or presence of the microprocessor to operate on car top inspection or hoistway access operation (if provided) in order to provide a reliable means to move the car if the microprocessor fails.
- The elevator controller shall utilize a microprocessor based logic system and shall comply with (ANSI/ASME 17.1) safety code for elevators. The control equipment shall have all control parameters stored permanently on erasable programmable read-only memories (EPROM), and shall have permanent indicators to indicate important elevator status's as an internal part of the controller. The system shall provide comprehensive means to access the computer memory for elevator diagnostic purposes without need for any external devices. Systems that require hook-up of external devices for trouble-shooting are not acceptable.
- Failure of any single magnetically operated switch, contractor, or relay to release in the intended manner or the occurrence of a single accidental ground or short circuit shall not permit the car to start or run if any hoistway door or gate interlock is unlocked or if any hoistway door or car door or gate contact is not in the made position. Furthermore, while on car top inspection or hoistway access operation, failure of any single magnetically operated switch, contractor or relay to release in the intended manner or the occurrence of a single accidental ground shall not permit the car to move even with the hoistway door locks and car door contacts in the closed or made position.
- Dedicated permanent status indicators shall be provided on the controller to indicate the following: when the safety circuit is open, when the door locks are open, when the elevator is operating at high speed, when the elevator is on independent service, when the elevator is on fireman's service, when the elevator is out of service timer has elapsed or when the motor limit timer or valve limit timer has elapsed. In addition, provide means of displaying other special or error conditions that are detected by the microprocessor.

- A motor timer shall be provided which, in the event of the pump motor being energized longer than a predetermined time, shall cause the car to descend to the lowest landing, open the doors automatically and then re-close them. The car calls shall then be canceled and the car taken out of service automatically. Operation may be restored by cycling the power disconnect switch or putting the car on access or inspection operation.
- A valve limit timer shall be provided which shall automatically cut off the current to the valve solenoids if they have been energized longer than a predetermined time. The car shall then be canceled and the car taken out of service automatically. Operation may be restored by cycling the power disconnect switch or putting the car on access or inspection operation.
- An out of service timer (T.O.S.) shall be provided which will automatically take the car out of service if the car is delayed in leaving the landing while there are calls existing in the building. The car shall not respond to hall calls while in this mode of operation, and the photo eye input shall be unresponsive in the event that a faulty photo eye unit was delaying the car.
- Door protection timer shall be provided for both the open and close directions which will help protect the door motor and which will help prevent the car from getting stuck at a landing. The door open protection timer shall cease attempting to open the door after a predetermined time in the event that the door is prevented from reaching the open position. The door close protection timer will reopen the doors for a short time in the event that the door closing attempt fails to make up the door locks after a predetermined time.
- A minimum of three different door standing open times shall be provided. A car call time value shall predominate when a car call only is canceled. A hall call time value shall predominate whenever a hall call is canceled. In the event of a door reopen from a photo curtain, or door open button, a separate short door time value shall predominate. The timing value for these timers must be field adjustable.
- Nudging: If the doors are prevented from closing for longer than a predetermined time, door nudging operation shall cause the doors to move at a slow speed in the close direction and to be unresponsive to the photo curtain. A buzzer shall sound while nudging operation is active.
- Hall or car call registration and lamp acknowledgment shall be by means of a single wire per call besides the power busses. Systems that register the call with one wire and light the call acknowledgment lamp with a separate wire are not acceptable.
- Fireman's Phase I emergency recall operation, alternate level Phase I emergency recall operation, and Phase II emergency in-car operation shall be provided according to applicable codes. Keyed (MFD-1)
- Independent service operation shall be provided such that the actuation of a key switch in the car-operating panel will cancel any existing car calls, and hold the doors open at the landing. The car will then respond only to car calls and will ignore hall calls. Car and hoistway doors will only close by constant pressure on car call buttons or a door close button until the car starts to move. While on independent service, hall arrival lanterns or jamb mounted arrival lanterns and gongs shall be inoperative. Keyed (EPCO-1)
- Simplex selective collective automatic operation shall be provided for all single car installations. Operation of one or more car or hall call buttons shall cause the car to start and run automatically provided the hoistway door interlocks and car door contacts are closed. The car shall stop at the first car or hall call set for the direction of travel. Stops shall be made in the order in which the car or hall calls set for the direction of travel are reached, irrespective of the order in which they were registered. If only hall calls are set for the opposite direction of travel exist ahead of the car, the car shall proceed to the most distant hall call, reverse direction, and start collecting the calls. For multiple car installations use duplex, triplex etc.
- The car shall be equipped with two-way leveling to automatically bring the car within plus or minus (1/4") of landing level at any landing regardless of load.
- A selector switch shall be provided on the controller to select high or low speed during access or inspection operation as long as speed does not exceed 150 feet per minute.

- A test switch shall be provided. In the "test" position, this switch shall allow independent operation of the elevator without the door open function for purposes of adjustment or testing the elevator. The elevator shall not respond to hall calls shall not interfere with the other car in a duplex installation.
- A timer shall be provide to limit the amount of time a car is held at a floor due to a defective hall call or car call including stuck push-buttons. Call demand at another floor shall cause the car to eventually ignore the defective call and continue to provide service in the building.
- Viscosity Control (optional and valve design must permit the use of this option) shall cause the car to accomplish the following operation. If a temperature sensor determines the oil is too cold, and if there are no calls registered, the car shall proceed to the bottom landing and, as long as the doors are closed, the pump motor will run without the valve coils energized in order to circulate and heat the oil to the desired temperature. In the event the temperature sensor fails, a timer shall prevent continuous running of the pump motor.
- **Solid State Motor Starter**
  - Provide a new solid-state motor starter to limit current inrush during starting and to provide gradual acceleration of the motor.
  - Motor starting shall not be initiated by mechanical contacts.
  - The starter shall include a current limit adjustment range of 200% to 450% of the overload adjustment range.
  - Provide an internal fault detection system, if the internal fault detection system detects a failure, power shall be removed from the motor.
- **Hydraulic Jack**
  - Install plunger-cylinder units plumb and accurate.
  - Plunger to be machined from extra heavy steel pipe (A53, Grade B) or equivalent mechanical tubing and ground to 24-32 or better micro-inch finish. The upper end of the plunger is equipped with a heavy steel plate inset and fillet welded into the plunger wall. This plate is drilled and tapped to receive standard machine bolts for attachment to the load platform. The bottom end of the plunger is provided with a steel striker plate welded to the plunger. Where the plunger is of multiple-piece construction, the coupling end is machine-bored, faced, and internally threaded to receive the coupling. All plunger joints are assembled and machined across the joint to assure matching surfaces.
  - Install schedule 40 PVC auxiliary casing with bottom completely sealed. Size casing for minimum 1.5" clearance to all jack assembly components.
  - Install piping without routing underground. Where not possible, rout piping through schedule 40 PVC before back filling.
  - Hydraulic hose for sound deadening is not permitted.
- **Hydraulic Pump**
  - Pumping Unit: The pumping unit shall be of integral design and shall include an electric motor connected to a submersible pump, a hydraulic control system, hydraulic fluid reservoir and necessary piping connections all compactly designed as a self-contained unit. This unit shall be designed for vibration free operation. The unit shall be factory adjusted and tested before shipment to the job site. The testing procedure shall include actual job type conditions of load, speed, etc. Refer to the drawings for remote arrangement of hydraulic unit for this project.
  - The pump shall be specifically designed for all hydraulic operation and shall be of the positive displacement type. Oil flow shall be controlled in such a manner that car operation will be smooth and quiet in both directions of travel. Accurate car leveling shall take place in both the up and down direction. The control valve shall be easily adjusted from the front of the power unit.
  - The "up start" system shall be adjustable and designed to initiate the stop of the elevator and shall control the acceleration smoothly and evenly.

- The "down start" system shall be adjustable and designed to initiate the stop of the elevator and shall control the deceleration of the elevator smoothly and evenly.
- The power unit shall have a shut-off valve which will isolate the oil reservoir to enable servicing of the pump hydraulic assembly. The shut off valve shall be located in the machine room as directed by Owner.
- A suitable muffler designed to withstand the high pressure shall be installed in the power unit in a blowout proof housing.
- Submersible Pump: The submersible pump shall be a positive displacement screw type to give smooth operation and shall be especially designed and manufactured for elevator service.
  
- **Elevator Pit Hydraulic Oil Return Pump**
  - Drip Pan Return Pump: 120V fractional h.p. pump suitable for pumping of hydraulic fluid. Furnish pump with float activated on/off switch.
  - Drip Pan: 24 gauge, galvanized sheet metal of suitable size to accommodate return pump.
  
- **Door Equipment**
  - Heavy Duty G.A.L. MOVFR Door Operating System, G.A.L. door rollers, door hanger tracks (car and hall) door pick-up assemblies, gate switch, door locks.
  - Provide emergency access in all hoist way doors.
  - All doors shall have 1-1/2 hr. label or other identification acceptable to governing authorities.
  - Provide adjustable nylon guide (by Nylube or Adams Elevator Equip. Co.).
  - Heavy duty doors. Provide door skin on both sides of elevator doors.
  
- **Lobby Position Indicator**
  - Provide tamper resistant lobby position indicator on the ground level, illuminated by light emitting diodes. By Elevator Products Co. (EPCO).
  
- **Smoke Detectors**
  - Smoke and heat detectors shall be compatible and tie into building fire system.
  
- **Hall Direction Indicator**
  - Up and down tamper resistant SURVIVOR PLUS as manufactured by Elevator Products Co. (EPCO). Direction indicators to be provided in the hall wall with a single chime or tone for up and double chime or tone for down direction and shall be illuminated by light emitting diode.
  
- **Photo Curtain**
  - Photo Curtain: An electric, passenger sensing device of the photo curtain shall project across the entrance to prevent the car and hoist way doors from closing if a passenger or object interrupts the curtain.
  - Nudging: If the doors are prevented from closing for longer than a predetermined time, door nudging operation shall cause the doors to move at a slow speed in the closed direction and to be unresponsive to the photo curtain. A buzzer shall sound while nudging operation is occurring.
  
- **Car Operating Station**
  - Flush mounted operating panel shall be mounted in the car return panel and shall contain the devices required for the specified operation. The buttons and devices shall be of the easy readability type and the floor designation buttons shall become illuminated when pressed and shall stay illuminated until the floor call is answered. Provide continuous hinge on panel for easy access to internal components. Locate hinges on side of panel nearest wall of the elevator. The car operating shall contain the floor designations, and all the controls indicated.

- Digital car position indicator, illuminated with light emitting diodes.
  - Fan key switch (EPCO-1)
  - Emergency stop key switch (EPCO-1).
  - Independent service key switch (EPCO-1).
  - Inspection/access key switch (EPCO-2).
  - Firefighter service key switch (MFD-1)
  - Alarm bell push type switch.
  - Light key switch (EPCO-1).
  - Engrave capacity and elevator designation.
  - Engrave “ INSPECTION CERTIFICATE ON FILE AT FACILITIES MANAGEMENT “
  - Emergency light.
  - Emergency light test button.
- Elevator Shutdown
    - Elevator power shall automatically shutdown prior to sprinkler activation. This is typically accomplished by the use of a shunt trip breaker activated by a heat detector.
    - Heat detector to be located no more than 24” from any fire sprinkler head installed in elevator shaft or machine room
    - Heat detector should also report to fire alarm system
    - Conduit circuits to shut down elevator power shall be monitored and supervised by the Fire Alarm System.

## EXECUTION

- **Telecommunication Link**

- Install communication cable for controller modem not to exceed 24” from controller.
- Install communication cable for car phone not to exceed 24” from controller.
- Install modem MC – PA board and modem outlet inside of controller.

- **Adjust And Balance**

- Make necessary adjustments of equipment to ensure elevator operates smoothly and accurately.

- **Protection**

- Locate and protect movable equipment and controls in such a way that they can only be operated by authorized persons.

- **Inspections**

- Obtain and pay for inspections and permits and make sure tests are as required by regulations of authorities. Conduct all tests and inspections in the presence of the Owner.
- Final inspection shall be after all new equipment is installed and operating correctly.
- Inspect installation in accordance with ANSI-A17.2
- Deliver test certificates and permits to Owner.

- **Operation And Maintenance**

- Instruct Owner’s personnel in proper use, operations and daily maintenance of elevators.
- Training shall include operation of diagnostic microcomputer and servicing of elevator microprocessor.
- Make final check of each elevator operation, with Owner’s personnel present and just prior to date of substantial completion. Determine that control systems and operating devices are functioning properly.
- Continuing Maintenance: Provide 1-year maintenance on elevators on an as-needed basis as part of standard 1-year warranty on new equipment and upgrades.

- Maintenance shall include systematic examination, adjustment and lubrication of new elevator equipment; replacement of seals, packing and valves to maintain required factor of safety; performance of maintenance work without removing car during peak traffic periods and providing 24 hour emergency call back service during maintenance period, at an additional cost to Owner.
  - Repair or replace electrical and mechanical parts of the new elevator equipment using only genuine standard parts produced by manufacturer of equipment concerned.
  - Ensure that competent personnel handle maintenance service. Maintain an adequate stock of parts for replacement of emergency purposes, locally, and have qualified personnel available at such places to ensure the fulfillment of this service without unreasonable loss of time.
- 
- **Cleaning**
    - Remove all trash and debris from site during elevator installation.
    - Clean all elevator surfaces, removing all dirt, dust, spots, and scratches. Any damage shall be repaired or replaced as directed by Owner, at no cost to Owner.
    - Prior to substantial completion, remove protection from finished or ornamental surfaces and clean and polish surfaces with due regard to type of material.
    - Remove tools, equipment and surplus materials from site.

**End of Section 14240**

## **DIVISION 14 - CONVEYING SYSTEMS**

### **Section 14440 – Lifts**

#### **Introduction**

The application and use of stair lifts to provide a means of wheelchair access on new and existing stairs requires careful consideration as these elements present significant operational, maintenance and safety concerns to the University. The University's experience has shown that only the following units provide reliable and trouble free service. Only the units identified below are to be considered acceptable for use on University projects.

#### **Part 1 - General**

#### **Part 2 - Products**

- Straight incline wheel chair lifts shall be Garaventa, model XPRESS II
- Vertical wheel chair lifts shall be Garaventa, model GVL-EN. Drive mechanism can be either hydraulic or screw type depending on the use and height of the lift.
- Curving or turning lifts, for going around corners or up a stairwell, shall be Garaventa models GSL-1 or GSL-3, depending on the specific needs of the unit.

#### **Part 3 – Execution**

- Factory assisted installation and set up is required for all lifts.

#### **End Of Section 14440**



## **DIVISION 15 - MECHANICAL**

### **Section 15000 - General Discussion**

#### **Introduction**

The work shall be in accordance with all rules, regulations, by-laws and requirements of all authorities having jurisdiction.

Refer any questions, clarifications regarding Division 15 to UA Facilities Design & Construction.

#### **Part 1 - General**

- Codes
  - The project shall comply with the latest edition of the following codes unless otherwise stated:
    - Arizona State Fire Code
    - International Building Code (2003)
    - National Electrical Code (2002)
    - OSHA 1910, regulations 29 CFR 1910 and 1926
    - International Mechanical Code (2003)
    - International Plumbing Code (2003)
    - N.F.P.A. in total
    - Americans with Disabilities Act
    - ASHRAE 90.1 - Energy
    - IAQ Guidelines for Occupied Buildings Under Construction (SMACNA)
    - ASHRAE Standard 62 (Ventilation)
    - ANSI/AIHA Z9.5 Laboratory Ventilation
    - ACGIH Industrial Ventilation Manual of Recommended Practices
    - OSHA 29 CFR 1919.146 Confined Spaces Standard
- Working In Confined Spaces
  - Whenever work is required within a confined space, e.g., utility vaults, utility tunnels, sumps, pits, sewers, etc., contact UA Risk Management and Safety Department for details and procedures on UA Confined Space Entry Program.
- Laboratory Design Criteria
  - Refer to UA DSS Tab C-3.
  - Discuss fume hood selection and HVAC system criteria with UA Facilities Design & Construction.
- Record Drawings
  - Provide a set of prints and clearly mark, as the job progresses, all changes and deviations from that shown on Contract Drawings. Drawings shall be kept up-to-date during construction and in addition to field measurements shall include; change orders, field instructions and all other changes.
  - Reference Division 01300 for further details.
- Buried Services
  - After inspection and approval of service lines in trenches, provide a continuous trace wire and attach to service line directly. The Mechanical Contractor shall take 'as-built' measurements, including all depths, prior to commencement of backfilling operations. It will not be sufficient to check off line locations. Definite measurements shall be taken for each service line. The location of buried piping shall be shown on the drawings and dimensioned from fixed points.

- Temporary Use Of Equipment

- Permission must be obtained from Architect/U of A prior to operating any mechanical systems during construction.
- Where the mechanical systems are operated during construction, the Mechanical Contractor shall maintain the system and equipment in proper operating condition.
- Before any area of the building is turned over to the U of A for acceptance and for beginning of the guarantee/warranty period, the systems and equipment shall be returned to the initial new condition e.g., by replacing used air filters with new air filters, cleaning the air side of all coils in the air handling systems, lubricating all bearings according to manufacturer's factory standards and adjusting control systems according to specifications and/or to suit the U of A.

- Provision For Future Expansion And/Or Installations

- Where piping, ductwork and equipment is indicated for use in future expansion of the building and/or for future installations within the building, the Contractor shall leave sufficient clear space and install the piping, ductwork and equipment in such manner that connections to the future building expansion and/or future installations within the building can be made without removing existing floors, walls, ceilings. The Contractor shall consult with the Architect/U of A whenever necessary for this purpose.
- Any piping stub-outs provided for future connections to domestic hot and cold water piping systems shall be arranged so that "dead legs" (i.e., pipe sections where there is no water circulation) are prevented. The termination point of any piping stub-out shall be as close to the main piping flow as physically possible. Where future branch lines must extend a distance greater than six (6) branch line pipe diameters or more than 18" from the main piping flow, a valved drain port or blind flange with a valved drain shall be provided at the end of the branch piping to allow periodic flushing.
- Abandonment of Domestic Water Piping
  - Verify routing of existing domestic hot and cold water piping systems prior to their being abandoned. Cap abandoned branch lines as close as physically possible to the main piping flow to eliminate "dead legs". Elimination of "dead legs" shall not hinder the proper operation of any existing hot water return, i.e., recirculation, systems.

**Part 2 - Products**

- No discussion.

**Part 3 - Execution**

- No discussion.

**End of Section 15000**

## **DIVISION 15 - MECHANICAL**

### **Section 15050 - Basic Mechanical Materials and Methods**

#### **Introduction**

Mechanical systems materials and methods of installation common to some or all of mechanical systems sections in Division 15.

#### **Part 1 - General**

- All piping and ductwork in finished areas shall be concealed in ceiling spaces, shafts, or chases.
- Electrical conduits shall not touch or be supported via pipes or ducts.
- Ensure fire and smoke separation rating of walls and floors is maintained following penetration.
- All electrical work associated with Division 15 shall comply with requirements of Division 16.

#### **Part 2 - Products**

- Valves
  - Sizes 6" and above shall have gear operator ball chain if located more than 7 ft. above floor.
  - Provide isolation Ball valves - 100% full-port, full-line size, bronze-body, threaded connections at all equipment and on all main branch take-offs.
  - Provide brass valve tags marked for the service. See pertinent service specification for valve type.
  - Butterfly valves shall be 100% bubble-tight shut-off. Lug type only. Iron body with bronze disk. Valves to have two year warranty. Use for throttling/balancing. Preferred manufacturers are Norris, Centerline or UA approved equal.
- Piping Labels
  - Provide at directional changes and/or each 20 ft. Labels to be pre-manufactured snap-on plastic wrap-around type sized to cover entire circumference of piping and insulation.
  - Labels to have integral color identification as established by ANSI Standard A13.1 - 1981.
  - Lettering shall be sized to be easily legible. Directional arrows shall indicate direction of flow and shall be located to point away from lettering.
- Escutcheons
  - Install in exposed locations, except in mechanical rooms.
  - Escutcheons to be hinged, chrome-plated type.
- Pipe Sleeves / Concrete Walls & Floors Above Grade
  - Shall be schedule 40 steel.
  - Sized for full dimensions of insulation and fire caulked where required.
  - Install in all exterior walls, fire walls and floors.
  - Floor sleeves to extend 1" above floor surface.
- Pipe sleeves in non-rated, non-masonry walls or partitions. Provide 24 gage galvanized steel.
- Pipe sleeves in rated non-masonry wall or partitions – provide listed approved fire-rated assemblies.
- Pipe sleeves installed below ground through exterior walls shall have mechanical type neoprene seals.

- Do not support pipe with sleeve.
- Pipe Hangers
  - Pipes on trapeze type hangers shall be firmly secured.
  - Use Vibra-Zorb cushioned supports on 1 ¼" pipe and smaller which is connected to vibrating equipment.
  - Provide piping support hangers to ensure that no sags occur. Minimum hanger rod sizing and maximum hanger spacing shall conform to following table:

	<u>Pipe Size</u>	<u>Spacing</u>	<u>Hanger Rod</u>
• Steel Pipe	½"	6'-0"	3/8"
	¾" through 1-¼"	8'-0"	3/8"
	1-½", 2"	10'-0"	3/8"
	2-½"	10'-0"	3/8"
	3"	12'-0"	3/8"
	4"	12'-0"	3/8"
	5"	12'-0"	1/2"
	6"	12'-0"	1/2"
• Copper Pipe	8-12"	12'-0"	5/8"
	½"	6'-0"	3/8"
	¾", 1"	8'-0"	3/8"
	1-¼ through 4"	10'-0"	3/8"
	5"- 6"	12'-0"	1/2"
• Cast Iron	8" and above	12'-0"	5/8"
	1 ½ "- 2"	1 ea. Joint	3/8"
	3"	1 ea. Joint	1/2"
	4" through 6"	1 ea. Joint	1/2"
	8" and above	1 ea. Joint	5/8"

- Vertical risers shall be supported at each floor line with steel riser clamps.
- Equipment Nameplates.
  - Provide nameplates for all pieces of equipment.
  - Nameplate shall be minimum of 3/32" thick laminated phenolic plastic.
- Access Doors
  - Minimum size 18" x 18" - provide 24" x 24" wherever possible.
- Motors shall have premium efficiency EPAC rating in accordance with IEEE Standard 112 test method B.
- Motors shall have a minimum service factor of 1.15 and the design load shall not exceed 1.0.
- Motors located in conditioned space shall have an ambient rating of 104 ° F (40 ° C). Motors in unconditioned space shall have an ambient rating of 122 ° F (50 ° C).

### Part 3 - Execution

- Workmanship
  - Piping to run parallel to building lines.
  - Locate groups of pipes parallel to each other, spaced to permit valve servicing.

- Particular attention must be paid to the proximity of mechanical piping and equipment to electrical conduit and cable.
- All underground utility pipe shall have a tracing wire that is electrically continuous. The wire shall be 14TW AWG stranded (green) wrapped around or buried alongside the pipe. The wire shall be terminated at either end in a box flush with the ground with 3 feet of coiled wire in the box.
- Pitch piping in direction of flow 1" per 40 ft.
- Piping to be inspected and pressure tested prior to insulation.
- Piping to be routed to allow access to equipment.
- Welding to be done by welders certified locally in the State of Arizona. Welders must have proof of certification in their possession.
- Weld inspection
  - Visual inspection on low pressure piping (CHW, Condensate, LPS, HW, etc.).
  - Visual inspection and optional radiography on medium and high pressure steam piping (MPS, HPS).
- Provide access in accordance with Manufacturer's recommendations, to all equipment to allow maintenance and servicing.
- Installation
  - Install strainers with full port ball valve size to strainer blowdown port. Install hose threaded connection on valves 3/4" and below.
  - All gauges to be installed with a single gauge manifolded with ball valves on both sides of pumps, heat exchangers, tunnel supply and return, etc.
  - Install valves with stems in vertical position except ball valves. Do not go below horizontal with ball valve stems.
  - Use 10 mil plastic wrap around copper pipe on ferrous hangers or supports.
  - Use dielectric fittings whenever joining dissimilar metals.
- Equipment Installation/Removal
  - Install to facilitate servicing, maintenance and repair or replacement of equipment components with minimum of interference with other installations.
  - Provide a means of removing any valve that is larger than 2" and is mounted six feet or more above floor level.
  - Domestic Water Piping Arrangement
    - Install to prevent the existence of sections of piping where water could stagnate, i.e., where no water circulation occurs.
    - Provide recirculating loops for all domestic hot water piping systems with pipe runs longer than 50 feet.
    - Arrange piping in such a manner that there are no "transitory dead legs", i.e., piping branch lines that contain stagnant water. All abandoned branches or futures to be as close to main as possible, but in no case longer than 6" pipe diameters or 18" for pipe over 3".
    - Refer to "Provisions For Future Expansion And/Or Installations" Section 15000 - General Discussion for the installation requirements of future connections.

**End of Section 15050**

**DIVISION 15 - MECHANICAL**

**Section 15100 - Valves**

**Introduction**

A listing of valves, their types and applications associated with the following mechanical systems:

- Plumbing piping and specialties (Section 15410)
- Hydronic piping and specialties (Section 15510)
- Steam piping and specialties (Section 15520)
- Specialty valves used only in a particular type of mechanical system may be found in design standards for that system

**Part 1 - General**

- Install valves of type and service outlined in locations outlined in this standard
- Standard products - use same manufacturer for multiple units of same type

**Part 2 - Products (Valves)**

<u>Service</u>	<u>Size</u>	<u>Type</u>	<u>Material</u>	<u>Connections</u>
Plumbing System (15410)	All	Gate	Bronze Body	Threaded
Dom. Water	All	Ball	Bronze Body	Threaded
Dom. Water	Thru 2"	Globe Disk	Bronze Body With Teflon Disk	Threaded
Dom. Water	22" & Larger	Globe Disk	Iron Body With Teflon Disk	Flanged
Dom. Water	All	Relief Valves	Bronze Body, Teflon Seat	Threaded
Natural Gas	All	Lubricated Plug Cock	Iron Or Bronze Body	Threaded
Hydronic Piping (15510)	Thru 2"	Ball	Bronze Body	Threaded
	22" & Larger	Butterfly	Iron Body With Bronze Disk	Lug Type
<u>Service</u>	<u>Size</u>	<u>Type</u>	<u>Material</u>	<u>Connections</u>
Steam	Thru 2"	Globe Disk	Bronze Body With Teflon Disk	Threaded
Condensate	All	Ball	Bronze Body	Threaded

- Ball valves shall be 100% full port, full line size.
- Butterfly valves to have 100% bubble tight-shut-off and full port sizing. Valves to have two year warrantee. Valves to be manufactured by Norris or Centerline.
- Gate valves to have non-rising stem and handwheel, inside screw and renewable composition

disk

### **Part 3 - Execution**

#### **C Workmanship**

- Valves 6" and over shall have gear operator ball chain fall if located more than 7 feet above floor
- Provide butterfly valves at all equipment and on all main branch take-offs
- Provide globe disc valves at all equipment and on all main branch take-offs in steam piping system
- Provide gate valves, ball valves and globe valves at all equipment and on all main branch take-offs
- Provide relief valves on piping and equipment as needed to meet code requirements
- Provide plug cock valves at connections to gas-fired equipment and in all branch piping.

**End of Section 15100**

## **DIVISION 15 - MECHANICAL**

### **Section 15200 Sound And Vibration Control**

#### **Introduction**

Equipment associated with the insulation and attenuation of airborne and impact sound.

Mechanical equipment, ductwork and pipework shall be isolated to ensure that applicable noise criteria curves as outlined in current ASHRAE Handbook are not exceed.

#### **Part 1 - General**

Standard products - use same manufacturer.

#### **Part 2 - Products**

#### **Part 3 - Execution**

- Provide vibration isolation for all mechanical motor driven equipment and for all horizontally suspended fan coil units.
- Provide neoprene side snubbers or restraining springs where side torque or thrust may develop.
- Spring mounts for equipment with operating weight different from installed.
- Provide adjustable limit stops on spring mounts for equipment with operating weights different from installed weight.
- Provide spring isolators on piping connected to isolated equipment as follows:
  - Up to 4" diameter - first 3 points of support
  - to 8" diameter - first 4 points of support
  - diameter and larger - first 6 points of support
- First point of support shall have a static deflection of twice the deflection of the isolated equipment.
- Isolators located outdoors or in a moist environment shall have 'hot-dipped' galvanized housings and 2 coats of neoprene on springs.
- Isolators shall not have less than 30% reserve capacity.
- Flex Connections



- Provide in piping connections to all reciprocating and/or rotating mechanical equipment.
- Provide in duct connections to AHU's.
- Silencers
  - Silencers to have rounded inlets and tapered diffuser outlets.
  - Absorption media to be bacteria and fungus resistant.

**End of Section 15200**

## DIVISION 15 - MECHANICAL

### Section 15250 - Mechanical Insulation

#### Introduction

Insulation products associated with:

- PIPING, DUCTWORK

#### Part 1 - General

- Use wrapped supply ductwork, except in acoustically critical applications where liner may be used only after written permission is given by the U of A/FDC. Lined ducts shall not be used in medical areas, clean rooms, all high velocity supply ductwork.

#### Part 2 - Products

- Pipe Insulation Schedule (minimum)

Fluid Design Operating Temperature Range, °F	Conductivity Range Btu•in./(h•ft <sup>2</sup> •°F)	Mean Rating Temperature °F	Nominal Pipe Diameter (in.)				
			1" and less	1 ½" - 2"	2 ½" - 4"	5" - 6"	8" and Larger
251-350°F	0.29-0.31	200	2.0	2.5	2.5	3.5	3.5
201-250°F	0.27-0.30	150	1.5	1.5	2.0	2.0	3.5
141-200°F	0.25-0.29	125	1.5	1.5	1.5	1.5	1.5
105-140°F	0.24-0.28	10	1.0	1.0	1.5	1.5	1.5
40-55°F	0.23-0.27	75	0.5	0.75	1.0	1.5	1.5
Below 40°F	0.23-0.27	75	1.0	1.5	1.5	1.5	1.5

- Duct Insulation (minimum)
  - 2" fiberglass with foil back wrap with a minimum density of 0.75 lb./ft<sup>3</sup>.
  - 1" fiberglass duct liner with heavy duty surface, (see Part 1 - General).
- Pipe Insulation Jacket
  - Interior, concealed - fiberglass, All Service Jacket (ASJ).
  - Interior exposed or in equipment rooms – cover piping less than 10 feet above finish floor with 8 oz. Canvas jacket sealed with water based lagging adhesive and sizing compound, like Foster 30-30.
  - Tunnel piping and exterior piping - fiberglass ASJ covered with embossed aluminum jacket with banding at joints and sealed with 25 year clear silicone.
  - Any insulated pipework installed within an air handling unit to be covered with PVC jacket.
- Equipment Insulation
  - Rigid, foil faced, fiberglass with a minimum density of 3.0 lb./ft<sup>3</sup>.

#### Misc. Product

- Closed cell foam insulation which meets smoke developed/flame spread ratings of 50/25 may be used only for interior refrigerant service applications

### **Part 3 - Execution**

- Provide fitted insulation which can be removed and reused around equipment, valves, flanges, etc.
- Use Z-strips on all leading edges of duct liner, (when permitted).
- Insulated fittings, i.e., elbows, tees, Y's to be packed and fitted with PVC covers.
- Install insulation per latest edition SMACNA Duct Construction Standards.
- Use welded pins for ductwork insulation attachment. No mechanical or glued attachments allowed.
- For pipe sizes greater than 1¼" provide calcium silicate inserts and metal shields to protect the insulation at each support.
- Domestic hot water piping shall be insulated.
- Cooling system condensate drain lines shall be insulated, including roof and area drains carrying condensate.
- Piping carrying fluid below 65 ° F and all steam piping to be insulated continuously through clamping, support and sleeving.

**END OF SECTION 15250**



## **DIVISION 15 - MECHANICAL**

### **Section 15300 - Fire Sprinkler Systems**

#### **Introduction**

This work shall be in strict accordance with all rules, regulations, by-laws and requirements of all authorities having jurisdiction including, but not limited to; NFPA codes, Arizona State Fire Code, U of A Department of Risk Management and Safety.

#### **Part 1 - General**

- Hydraulic calculations shall be prepared and sealed by a registered professional engineer in the State of Arizona, and Sprinkler System Shop drawings to be submitted to the State Fire Marshal for approval.
- Hydraulic design calculations, shall include an allowance for a 10PSI pressure drop for the future installation of a back-flow preventer.
- Engineer and Contractor to conduct water supply static and residual tests, witness by the UA, and provide fire flow information on shop drawings and hydraulic calculations.
- In new construction or where space allows in renovation projects, provide a “pipe spool piece” to accommodate the future installation of a back-flow preventer.
- Provide an 8 ½" x 11" Map Key Plan for each floor of building, indicating the location of the following:
  - Main Control Valves
  - Fire Alarm Panel
  - Fire Dept. Connection
  - Back Flow Preventer (if provided)
  - Fire Alarm Bell
  - Auxiliary Drain Valves
  - Inspectors Test Connections
- Key Plan shall be provided at main control/zone valve location. See Typical Detail 15300-D1.
- All valves shall be readily accessible for maintenance.
- Provide system signage and identification in accordance with NFPA 13.
- Provide an additional copy of system “as-built” drawings for use of U of A Fire Safety Dept.
- To facilitate the annual fire pump test required by NFPA all fire pump installations shall include a valved by-pass. This by-pass is in addition to the by-passes normally prescribed for the jockey pump and suction supply pressure line, both of which employ a check valve. The testing by-pass allows the test to be performed without flooding the streets. A small valved drain should also be provided with this testing by-pass to remove some of the heated water generated by the pump test.

#### **Part 2 - Products**

- Piping shall be schedule 40 ASTM A-53 Grade A or B.
- All grooved fittings shall be manufactured by Victaulic.

### Part 3 - Execution

- In areas subject to freezing provide minimum pipe size of 2".
- U of A Risk Management and Safety and UA Fire Safety Dept. to be notified 48 hours in advance of all system tests, e.g. underground flushing, hydrostatic test, flow alarm test, fire pump test (if applicable), fire alarm/final acceptance test.
- No saddle type fittings shall be used on fire protection systems.
- Inspector's Test Connections and main drain shall be piped to a suitable location outside of building. (Confirm location with U of A Fire Safety Dept.). Do not pipe to a floor drain, janitor's mop sink or similar.
- System piping should not be buried beneath building slabs on grade.
- In all new construction the entire system shall have a final heads on 2 hour 200 psig pressure test through the FDC.
- Check valves, sprinkler valves and flow switches and main drain valve shall be readily accessible.
- At check valves, support piping independent of valve to allow for service removal without additional pipe support.
- FDC shall be wall mounted to the building structure.
- Locate the inspector's tests at the most hydraulically remote points in the system.
- Make provisions to drain all trapped water in dry standpipe systems.
- Provide post indicating valves on all systems. Indicating valves shall be equipped with a tamper switch connected to the building fire alarm control panel.
- Local bell shall be powered and supervised by the fire alarm panel.
- On new installations, do not use saddle tees. Use grooved fittings or welded outlets only.
- Do not enclose Victaulic fittings within construction.
- All pendant sprinkler heads in suspended ceilings to be installed at quarter points or center of ceiling tile.
- Floor zone valves should be located together at ground level in a room accessible from the outside. Confirm location with owner.
- Shop drawings shall incorporate all of the design features shown on the contract drawings. Any deviations deemed necessary by the designer shall be clearly identified on the shop drawings, ie: clouded.
- Contractor shall submit shop drawings to the Architect/ Engineer and FDC project manager for review and approval, prior to submittal to the State Fire Marshal.
- All new construction shall be fully sprinklered and equipped with class A fire alarm system.

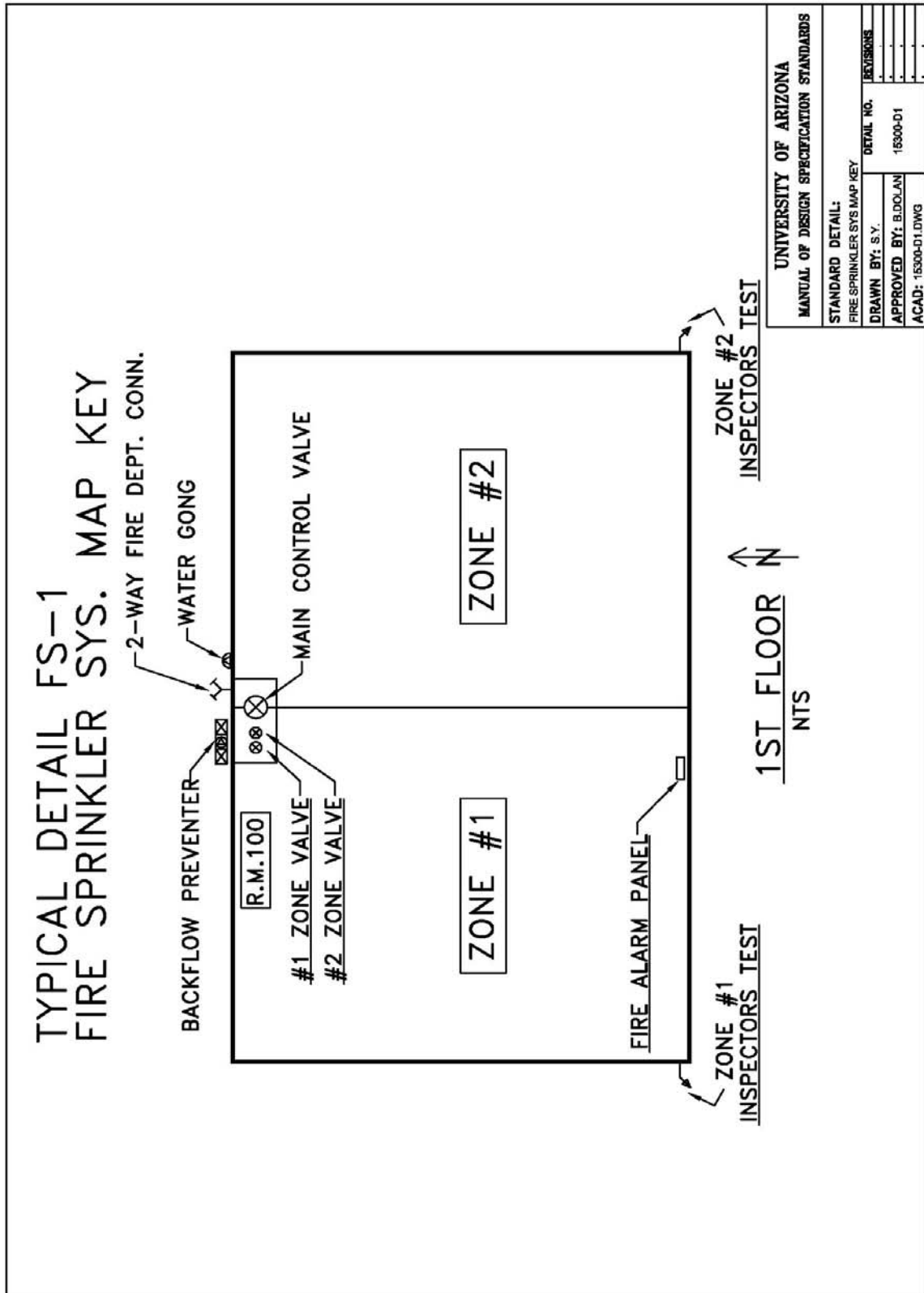

UNIVERSITY OF ARIZONA	
MANUAL OF DESIGN SPECIFICATION STANDARDS	
STANDARD DETAIL: FIRE SPRINKLER SYS MAP KEY	
DRAWN BY: S.Y.	DETAIL NO. 15300-01
APPROVED BY: B.DOLAN	REVISIONS
ACAD: 15300-01.DWG	

End of Section 15300

**DIVISION 15 - MECHANICAL**

**Section 15410 - Plumbing Piping And Specialities**

**Introduction**

Piping and specialties associated with plumbing systems including:

DOMESTIC WATER SYSTEMS, SANITARY SEWER AND WASTE PIPING SYSTEMS, LABORATORY  
 WASTE SYSTEMS, NATURAL GAS

**Part 1 - General**

- Refer to 15050 for common piping materials and methods.
- Single stack waste vent systems (sovent) shall not be designed into any facility.
- Refer to meter requirements (attachment to Section 15970).

**Part 2 - Products**

- Pipe Schedule - Above grade

<u>Service</u>	<u>Size</u>	<u>Pipe</u>	<u>Fittings</u>	<u>Joints</u>
Domestic Water	Up to 2"	Copper - Type "L" Seamless Hard Drawn	Wrought Copper or Cast Brass	6% Silver Solder
	2 1/2" and larger	Copper - Type "L" Seamless Hard Drawn	Wrought Copper	15% Silver Brazed
Natural Gas	Up to 2"	Schedule 40 Black Steel	Black Steel	Threaded
	2 1/2" and larger	Schedule 40 Black Steel	Black Steel	Beveled Weld
Drainage/Vent Piping, except Lab waste	All	Cast Iron, Service Weight	Cast	Hubless With Husky SD 2000 Assemblies-or UA approved equal.
Sanitary Sewer/Waste Below Grade	All	Cast Iron, Service Weight	Cast Iron	Hubless With Husky SD 4000 assemblies.
Sanitary Sewer/Waste /Vents Above Grade	All	Cast Iron, Service Weight	Cast	Hubless With Husky SD 4000 assemblies, or approved equal



<u>Service</u>	<u>Size</u>	<u>Pipe</u>	<u>Fittings</u>	<u>Joints</u>
Laboratory Waste/Vent	All	Polypropylene (Fuseal)	Polypropylene DWV	Fusion Welded
Laboratory Waste Vents (In plenums)		PVDF	PVDF	Fusion Welded

- Pipe Schedule - Below Grade

Service

Domestic Water	Same as for above grade except use type "K" copper for below ground and 15% silver brazed joints.
Natural Gas	Same as for above grade with sealed coating.
Drainage Piping-except Lab waste	Same as for above grade, use Husky SD4000 or UA approved equal couplings..
Laboratory Waste	Same as for above grade Duration for high temperature waste (auto clave, cage washer etc.)

- Back Flow Prevention: Backflow prevention standards will be equal to or greater than USC's Foundation For Cross-Connection Control and Hydraulic Research Manual #9, or the newest edition printed.
- Hose Bibbs: Keyless in public areas.
- Wall Hydrant: Automatic-draining, anti-backflow type. Provide one operating key.
- Floor Drains: Cast iron body. Floor drains for use as area drains in exterior slab on grade shall be furnished with anchor flange. Inlet fittings shall be cast iron with threaded inlet and threaded or spigot outlet and trap seal primer valve connection. Airgap fittings shall be cast iron or cast bronze, with fixed air gap, inlet for drain pipe or tube, and threaded or spigot outlet. Provide seepage flange at all floor drains in suspended slabs. Provide trap primers at all floor drains.
- Floor sinks: Acid resistant enamel coated cast iron. Strainer/grating shall be chosen appropriate for service.
- Roof Drains and Overflow Drains: Cast iron roof drain with cast metal dome strainer.
- Roof Flashing Assemblies: construct of four pound per square foot lead (min. of 24" x 24" cut for drain and clamped at collar).

**Part 3 - Execution**

- Maintain a minimum of 50% penetration of brazed joints.
- Excavation for buried piping shall be graded to provide a smooth foundation throughout length of piping. Bedding with clean sand to indicated level. Dig bell holes at each pipe joint to relieve protrusions of loads and to ensure continuous bearing of pipe barrel on foundation.
- Install sanitary building drain piping at a minimum slope of ¼" per foot (2 percent).
- For natural gas piping, provide dirt leg at each point of connection to equipment.

- Install trap seal primer valves with valve outlet piping pitched down toward drain trap a minimum of 1/8" inch per foot (1 percent) and connect to floor drain body, trap, or inlet fitting. Trap primers must be accessible.
- Install cleanouts in drain piping as required by the plumbing code and at each sewer main change in direction of 90°, at minimum intervals of 50 feet for piping 4 inches and smaller and 100 foot minimum intervals for larger piping. Install cleanouts at the base of each vertical soil or waste stack. Exterior cleanouts shall be two-way.
- Extend wall cleanouts out to finished wall.
- Reduced pressure backflow preventors shall be installed at service into building, at connections between potable and non-potable water systems.
- Double check backflow prevention assemblies shall be installed at applications such as photo labs, etc.
- Anti-siphon, pressure type vacuum breakers shall be installed at connection to irrigation systems.
- Install laboratory waste piping in an accessible pipeway.
- Install strainer on building potable water supply after building shut-off and prior to backflow preventor.
- Install ball valves with hose end threads for system drains.
- Water hammer arrestors to be sized according to number of fixture units and installed Between last 2 fixtures of branch with quick closing devices (e.g. flush valves, solenoid valves, etc.).
- Provide floor drains for all wet areas. Floor sinks shall be used for indirect waste only. Floor sinks shall be installed with rim above finished floor.
- Ball valves to be threaded ends with downstream union.
- Top of floor drain grate shall be the lowest point on the floor and shall readily drain the entire floor.

**End of Section 15410**

## **DIVISION 15 - MECHANICAL**

### **Section 15440 - Plumbing Fixtures**

#### **Introduction**

Fixtures and appurtenances associated with the use of plumbing system piping including:

DOMESTIC WATER SYSTEMS, SANITARY SEWER SYSTEMS

#### **Part 1 - General**

- Refer to Section 15000 "Provisions for Future Expansion and/or Installations and Section 15050 Part 3 - Execution".
- All fixtures shall be of the "water saving type".
- Install fixtures as required for either standard or handicapped accessible service per ADA.

#### **Part 2 - Products**

- Water Closets, Wall Mount shall be/provided with:
  - Vitreous china construction, white
  - Elongated bowl
  - 1 ½" inlet spud
  - Siphon jet action
  - ANSI Standard A112.19.2
- Toilet Seats shall be:
  - Open front.
  - Injection molded of high strength, impact, and chemically resistant polypropylene.
- Flushometers
  - Manufactured by Sloan (Royal # 111 for water closets 1.6 gpf, Royal #186 for urinals, 1.0 gpf)
- Faucets And Trim shall be/provided with:
  - Cast brass with polished chrome plating.
  - All faucets and trim furnished shall be by Chicago Faucet or American Standard.
  - No push button faucets.
  - Single lavatory faucet for rest rooms (no hot water).
  - Moderators
  - Plug and tailpiece: P.O. plug with 13" tailpiece. Non-removable strainer with integral spud. (No. 327)
  - DI water faucets shall be PVDF lined, self closing, with swing gooseneck.
- Wall Mount Lavatories shall be/provided with:
  - Vitreous china, with
  - Front overflow
  - Self draining deck area with contoured back and side splash shields
  - 4" centers or as required for handicapped faucets
  - Equipped for carrier

- ANSI Standard A112.19.2
- Urinals shall be/provided with:
  - Vitreous china, construction, white
  - Waterless
  - 2" female threaded outlet
  - Two wall hangers
  - ASME Standard A112.19.2 M-95, ANSI Z 124.9-94
- Mop Sinks (Floor Service Sink) shall be/provided with:
  - Acid resisting, enameled cast iron
  - Removable vinyl-coated rim guard
  - 3" drain
  - ANSI Standard A112.19.1.M
- Service Sinks shall be/provided with:
  - Acid Resisting, enameled cast iron
  - Rim guard
  - Wall Hanger
  - Drilled for back mount faucet
  - Floor supported trap
  - ANSI Standard A112.19.1.M
- Stainless Steel Sinks shall be/provided with:
  - 18 gauge brushed stainless steel.
  - Flat back extension with centerset holes 8" on center for faucet set.
- Water Coolers shall be/provided with:
  - Single unit, installed at height for handicapped accessibility/operation.
  - One-piece stainless steel backsplash plate and basin.
  - Exterior casing to be stainless steel or vinyl coated steel.
  - 8.0 gallons per hour minimum capacity.
  - Non-CFC refrigerant.
  - Fittings, Except Faucets
    - Angle stops and other fittings shall be fabricated of brass with a polished chrome plated finish.
    - Trap piping and tailpiece shall be chrome plated finish.
    - Escutcheons: polished chrome-plated, steel shell wall flange with friction clips.
- Plumbing Fixture Supports shall be/provided with:
  - ASME rated for service.
  - Chair carriers: supports with steel pipe uprights for wall hanging fixtures. Heavy duty chair carrier shall have rectangular steel uprights.

### **Part 3 - Execution**

- Refer to Section 15000 "Provisions for Future Expansion and/or Installations and Section 15050 Part 3 - Execution".
- Installation

- Install stop valves in a readily accessible location.
- Install escutcheons at each wall and ceiling penetration in exposed locations and within cabinets and millwork. Use deep pattern escutcheons where required to conceal protruding pipe fittings.
- Seal fixtures to walls, floors, and counters using a sanitary type, one part, mildew resistant white silicone sealant.
- Single faucets shall not be used in conjunction with cock hole covers. Provide lavatory or sink with correct hole configuration for specified service.

**End of Section 15440**

## **DIVISION 15 - MECHANICAL**

### **Section 15450 - Plumbing Equipment**

#### **Introduction**

Equipment associated with building plumbing systems including:

WATER SOFTENER, SEWAGE EJECTOR PUMPS, HOT WATER GENERATORS, WATER HEATERS,  
WATER PRESSURE BOOSTER SYSTEMS.

#### **Part 1 - General**

- For energy conservation purposes, hot water shall not be provided to rest rooms.
- Use central plant steam via heat exchangers for hot water. Consider impact of summer shutdown of steam service, (back up systems may be required) - consult with UA Facilities Design & Construction.
- Where used, water heaters shall be placed as near point-of-usage location as possible. Pumped recirculation system is required for piping systems lengths exceeding 50 feet.
- Small clear water ejector systems (fractional horsepower only) may use drop-in submersible pump.
- Autoclaves shall be connected to campus steam system and not furnished with individual steam generators. Verify adequate steam supply main pipe size and available pressure. Provide timers with over-ride button to shut off steam and water when not being used.

#### **Part 2 - Products**

- Water Softeners shall be dual automatic regenerating type to provide service during routine maintenance, complete with fiberglass tanks
- Sewage Ejector Pumps shall be self-priming, base mounted pump with suction line extended to sewage pit, high water alarm to U of A Campus EMCS. Provide two sewage ejector pumps for stand-by service with lead/lag control for building service application. Provide vent bleed valve per manufacturer's recommendation.
- Preferred manufacturer is Gorman Rupp or UA approved equal.
- Water Heaters - Gas fired preferred, although electric spot heaters may be used where economically justified. Lined galvanized steel tanks. 80% minimum efficiency.
- Water Pressure Booster System shall be Duplex pumping system, removable bladder type hydropneumatic pressure tank.
- Multi-plex pumps shall each have an H-O-A switch, disconnect, and overcurrent protection.

#### **Part 3 - Execution**

- All equipment shall be installed with isolation valves (threaded ball or flanged butterfly) - 100% full-port, full line size, bronze body at the equipment, drains, thermometers (on heat exchange equipment) and pressure gauges.
- Provide drip pans with piped drain beneath water heaters placed in areas other than in equipment rooms.
- Provide line size (2" maximum) full port ball valve blowdown on each side of plate and frame heat exchangers (typically 4).

#### **End of Section 15450**

**DIVISION 15 - MECHANICAL**

**Section 15480 - Plumbing Special Systems**

**Introduction**

Special plumbing systems including:

LABORATORY WATER SYSTEMS, MEDICAL GAS SYSTEMS, COMPRESSED AIR SYSTEMS, VACUUM SYSTEMS

**Part 1 - General**

No discussion

**Part 2 - Products**

- Pipe Schedule

<u>Service</u>	<u>Size</u>	<u>Pipe</u>	<u>Fittings</u>	<u>Joints</u>
Laboratory RO Water	All	Sch. 80 PVC	Sch. 80 PVC	Solvent Welded
High Purity H <sub>2</sub> O	All	Polypropylene Type 1 Sch. 80	Polypropylene Type 1 Sch. 80	Fusion Weld Mech. Joint
Medical Gas	All	Copper Type "L" Oxygen Grade	Wrought Copper	15% Silver Solder
Compressed Air	All	Copper Type "L"	Wrought, Copper	<i>Less Than 0.2% Lead Alloy Solder</i>
Lab Vacuum	All	Copper Type "L"	Wrought Copper Or Cast Brass	<i>Less Than 0.2% Lead Alloy Solder</i>

- Laboratory High Purity Water Systems
  - Utilize campus-wide RO water system where available with local filtration purifiers where required by user.
  - Where building wide high purity water is required, utilize a complete system by a single manufacturer to ensure a single point of responsibility.
  - Piping system shall be Schedule 80 PVC solvent welded for campus-wide RO system.
  - No tapered connectors shall be utilized on faucets.
  - Sterilize system before handover to U of A.
- Compressed Air Systems shall be/provided with:
  - Oil-less compression for medical application.
  - Automatic drain valve c/w isolation valve.
  - Refrigerated air dryer c/w air dryer bypass valve.
  - Conditioned inlet air preferred.
  - Filter inlet.
  - Chilled water "after cooler" before refrigerated air dryer.
  - Oil and moisture separators.

### **Part 3 - Execution**

- Workmanship
  - Piping pressure test shall be 150% of maximum operating pressure (or 100 psig minimum) for 4 hours
  - System Cleaning - fill laboratory water systems and hold water for 24 hours prior to flush. Flush clean 3 times.
  - All vacuum pumps must be vented to the exterior of the building.
  - Vacuum pump tanks must be drained to waste container.
  - Provide bypass around filter assembly for servicing.
  - Purge medical gas systems with nitrogen during soldering.



### SPECIAL GASES MANIFOLD DIAGRAM

**NOTE:**  
RACK PIPING MANIFOLD/ HEADER ASSEMBLY & COMPONENTS ON WALL W/ UNISTRUT.

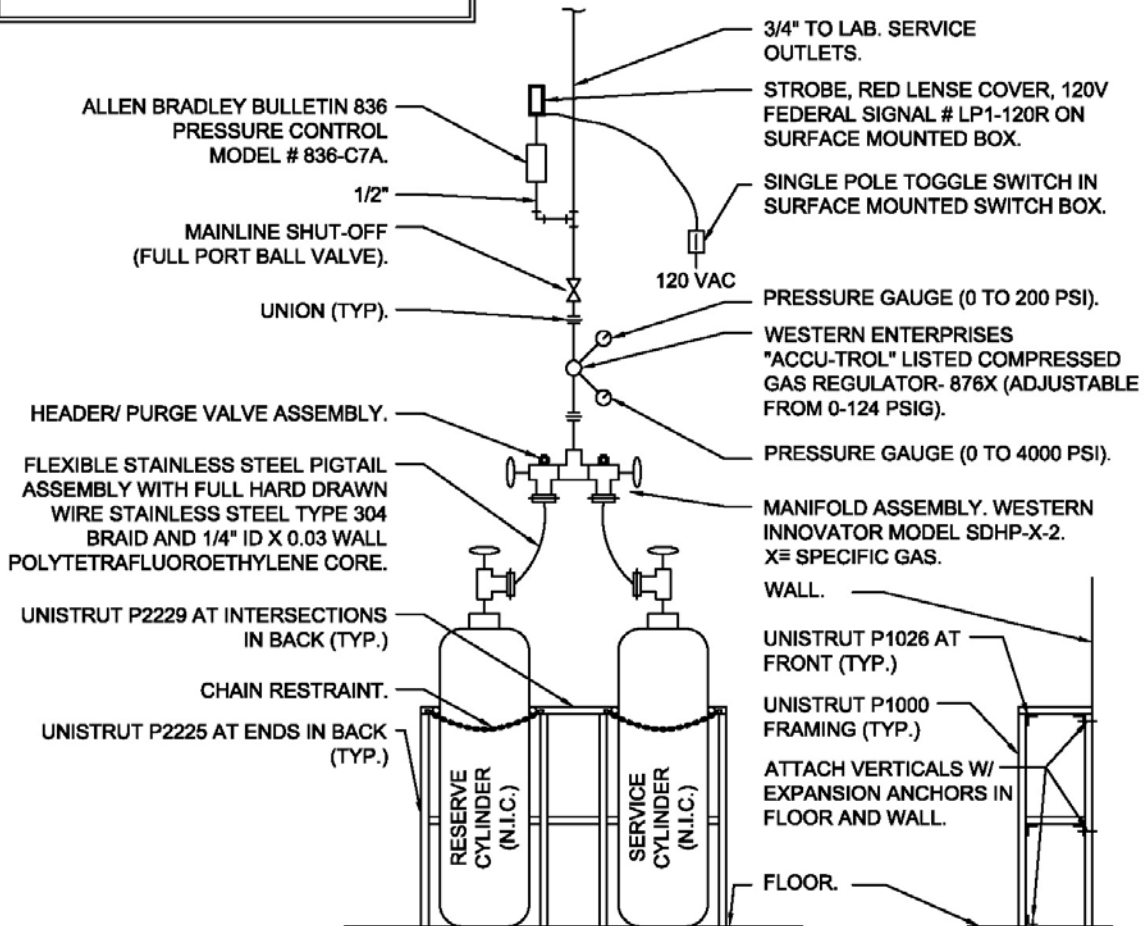

**NOTE:**  
PRESSURE SWITCH/ CONTROL SHALL ENERGIZE STROBE WHEN MAIN LINE PRESSURE IS 15 PSIG LESS THAN SYSTEM DISCHARGE (SETTING) AT PRESSURE REGULATOR.

SERVICE SCHEDULE		
SERVICE	PIPE SIZE	PRESSURE
ARGON	3/4"	80 PSI
HELIUM	3/4"	80 PSI
NITROGEN	3/4"	80 PSI

**NOTE:**  
WALL MOUNTED CYLINDER BRACKET SIMILAR TO GRAINGER SERIES 4ZH MAY BE USED INSTEAD OF UNISTRUT SUPPORT WITH USER'S PERMISSION.

DRAWING 15480

<b>UNIVERSITY OF ARIZONA</b>		
<b>MANUAL OF DESIGN SPECIFICATION STANDARDS</b>		
STANDARD DETAIL:		
<b>SPECIAL GASES MANIFOLD DIAGRAM</b>		
DRAWN BY: KML	DETAIL NO.	REVISIONS
APPROVED BY: S. H.	15480-D1	
ACAD: 15480		

**DIVISION 15 - MECHANICAL**

**Section 15510 - Hydronic Piping and Specialties**

**Introduction**

Piping and specialties associated with heat transfer equipment including:

CHILLED WATER, PROCESS COOLING WATER, CONDENSER WATER, HEATING WATER

**Part 1 - General**

- Install a strainer with differential pressure transmitter to EMCS on building side of isolation valve for chilled water supply from tunnel system. Install a single pressure gauge across strainer (see Section 15050 requirements).
- Use reverse return piping concept and eliminate balancing devices for all banked coil application and wherever practical.
- Use circuit setting devices in closed loop systems. Preferred design is a variable flow pumping system controlling system differential pressure and using externally adjustable pressure dependent circuit setters at each point of use.
- Provide 3-way valves in heating water piping at end of branch line units only.
- Design heating water systems with a 40°F temperature differential. – (140°F- 180°F)
- Refer to meter requirements (attachment to Section 15970).

**Part 2 - Products**

- Pipe Schedule - Above Ground

<u>Size</u>	<u>Pipe</u>	<u>Fittings</u>	<u>Joints</u>
• Up to 2"	Copper Type "L" seamless hard drawn	Wrought copper	Less Than 0.2% Lead Alloy Solder
• 2 ½" larger	Copper Type "L" seamless hard drawn <u>Or</u> Schedule 40 Black Steel	Wrought copper  <u>Or</u> Forged carbon steel	15% silver brazed  <u>Or</u> bevel welded

- Pipe Schedule - Below Ground

• Up to 2"	Copper Type "K" seamless hard drawn	Wrought copper	6% silver solder
• 2 ½" & larger	Copper Type "K" seamless hard drawn <u>Or</u> Ductile iron cement lined	Wrought copper  <u>Or</u> Ductile iron cement lined	15% silver brazed  <u>Or</u> Push-on or mechanical

- Pipe Gasketing - Water Services - Garlock or UA approved equal.

- Valve Types: Butterfly, Globe or Ball. No Gate Valves shall be used.
- Preferred manufacturers are Norris, Centerline or UA approved equal.
- Thermometers
  - Adjustable angle type 9" die cast aluminum thermometer with separable well. Select with normal operating range at the midpoint of the scale. Install thermometer on both sides of each flow stream across coils, heat exchangers, etc.
- Pressure Gauges
  - Cast aluminum with 4 ½" dial. Select with normal operating range at the midpoint of the scale. Provide with pressure snubber and shutoff valve. Provide gauges at each pump, coil, heat exchanger, etc. Use a single gauge manifold with valving on each side of equipment.
- Expansion Tanks
  - Provide diaphragm-type compression tank with replaceable diaphragm.
- Air Vents
  - Provide automatic float and trap air vents in mechanical rooms only.
- Expansion Joints
  - Provide bellows type. Type 316 stainless steel.
- Pressure Regulators
  - Brass body, threaded connections.
- Flow Regulating Devices
  - Circuit setter with external adjustment and indicator with threaded connections only.
  - Pressure independent flow balancing - restrict use to areas approved by U of A.
- Hoses
  - High pressure, braided stainless steel and rated for temp and pressure requirements.

### **Part 3 - Execution**

- Weld inspection: see Specification 15050 Part 3 Execution.
- Maintain a minimum of 50% penetration of brazed joints.
- Perform a minimum of three passes on weld joints (root, filler, cap).
- Route piping to allow sufficient access to all equipment, valves, controls, etc., for maintenance.
- In general, piping shall be installed below electrical conduits not requiring maintenance access.
- Piping shall be secured at each trapeze hanger or support.
- Install piping sufficiently below structure to allow top air vents.

- Provide isolation valves on each side of strainers and full port ball valve on blow down. Provide hose thread connection on blow down port  $\frac{3}{4}$ " and below.
- Provide air vent in pipe riser. Install automatic air vents in equipment rooms and manual air vents elsewhere, with isolation valve at all system high points and piped to drain. Minimum vent piping size is  $\frac{1}{2}$ ".
- Provide ball valves with hose end threads for system drains.
- When an existing system "hot tap" is necessary, provide a full port ball valve to isolate the new branch line.
- Do not use circuit setter as isolation valve.
- All gauges to be installed with a single gauge manifold.

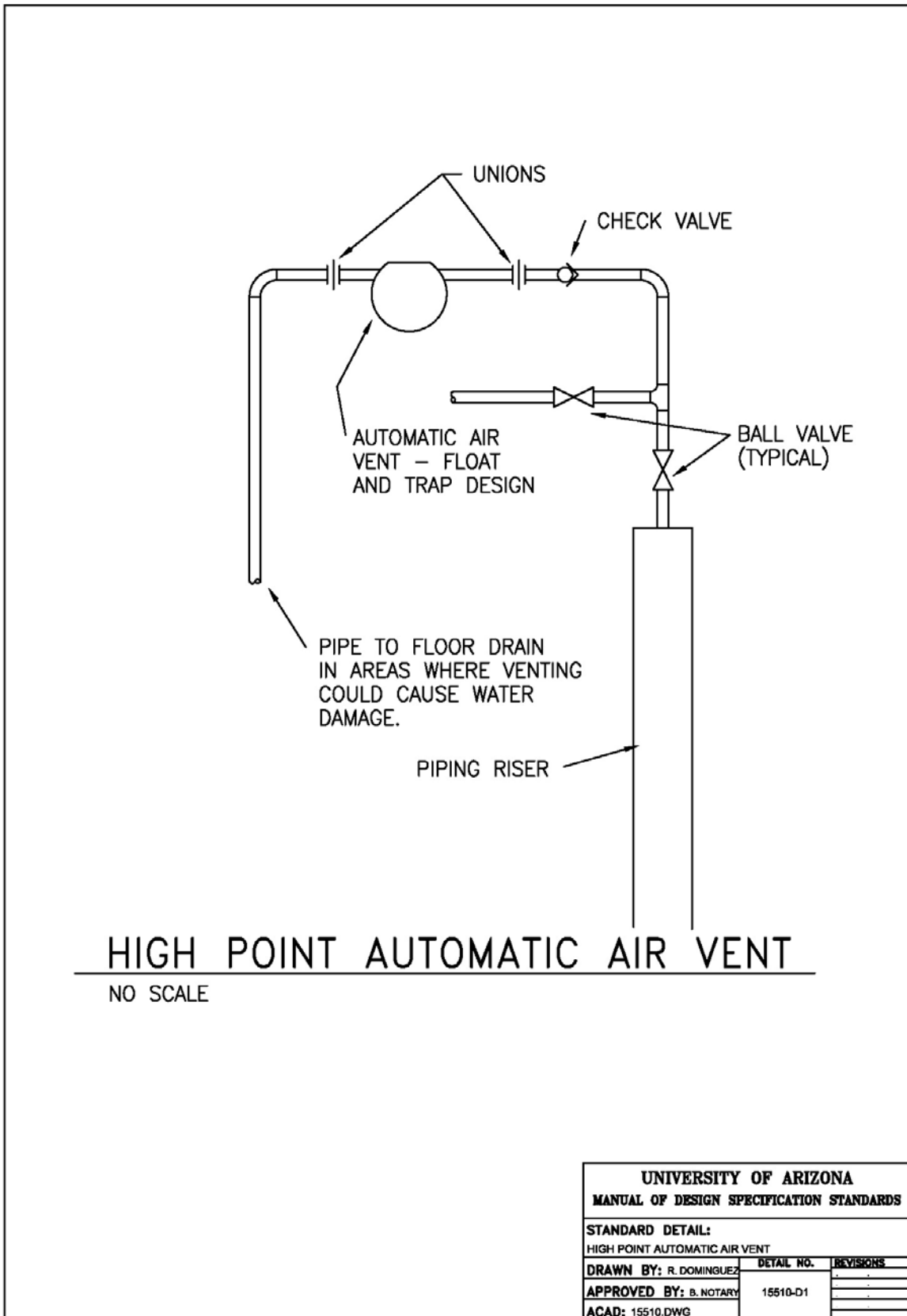

End of Section 15510

## DIVISION 15 - MECHANICAL

### Section 15520 - Steam Piping and Specialties

#### Introduction

Piping and specialties associated with:

#### STEAM AND STEAM CONDENSATE SYSTEMS

#### Part 1 - General

- Refer to meter requirements (attachment to Section 15970).

#### Part 2 - Products

- Pipe Schedule -

<u>Service</u>	<u>Size</u>	<u>Pipe</u>	<u>Fittings</u>	<u>Joints</u>
Steam	Up to 2"	Sch. 40 seamless black steel	Forged carbon steel	threaded, bevel weld, or welded socket
Steam	2 ½ " and larger	Sch. 80 seamless black steel	Forged carbon steel	bevel welded
Condensate	All	Copper Type "L" seamless hard-drawn	Wrought copper	15% silver brazing

- Pipe Gasketing - Steam services – Spiral wound – “Flexataulic” or UA approved equal.
- Valves
  - Condensate valves to be steam rated ball valves.
  - Steam valves to be steam rated globe valves.
  - Provide valves at all equipment and on all main branch take-offs.
- Pressure Gauges Shall Be:
  - Rated for steam service.
  - Cast aluminum with 4 ½" dial.
  - Selected with normal operating range at the midpoint of the scale.
  - Furnished with pressure snubber and shutoff valve.
  - Installed on both sides of all pressure regulators and at all steam using equipment.
- Strainers Shall Be:
  - Screwed 250# cast-iron, threaded through 2".
  - Flanged (150 lb.) 2 ½" and larger cast iron.

- Size 100 mesh.
- Installed ahead of steam traps and control valves.
- Steam Traps: Preferred manufacturers are.
  - Armstrong bucket for end of line drip and main lines.
  - TLV float & thermostatic for modulating service.
- Pressure Regulators Shall Be:
  - Fisher, Industrial Type 92B.
  - Globe valve in by-pass.
  - Vented to exterior of building through relief valve.
- Expansion Joints Shall Be:
  - Yarway "Gun-Pakt"
  - Stainless steel body and travel arm.
- Condensate Pumps shall be:
  - Spirax/Sarco
  - Cast-iron housing
  - Steam powered complete with compressed air back up where available.

### **Part 3 - Execution**

- Workmanship
  - Avoid direct - buried steam and condensate systems.
  - Steam trap and strainer shall be piped as an assembly with isolation valve and union at each end of the assembly.
  - Terminate relief valve vent lines outdoors in safe location - verify with U of A.
  - Use eccentric reducers in steam piping to assure level bottom.
  - Pitch steam and condensate piping downward in direction of flow at ½" per 10 ft.

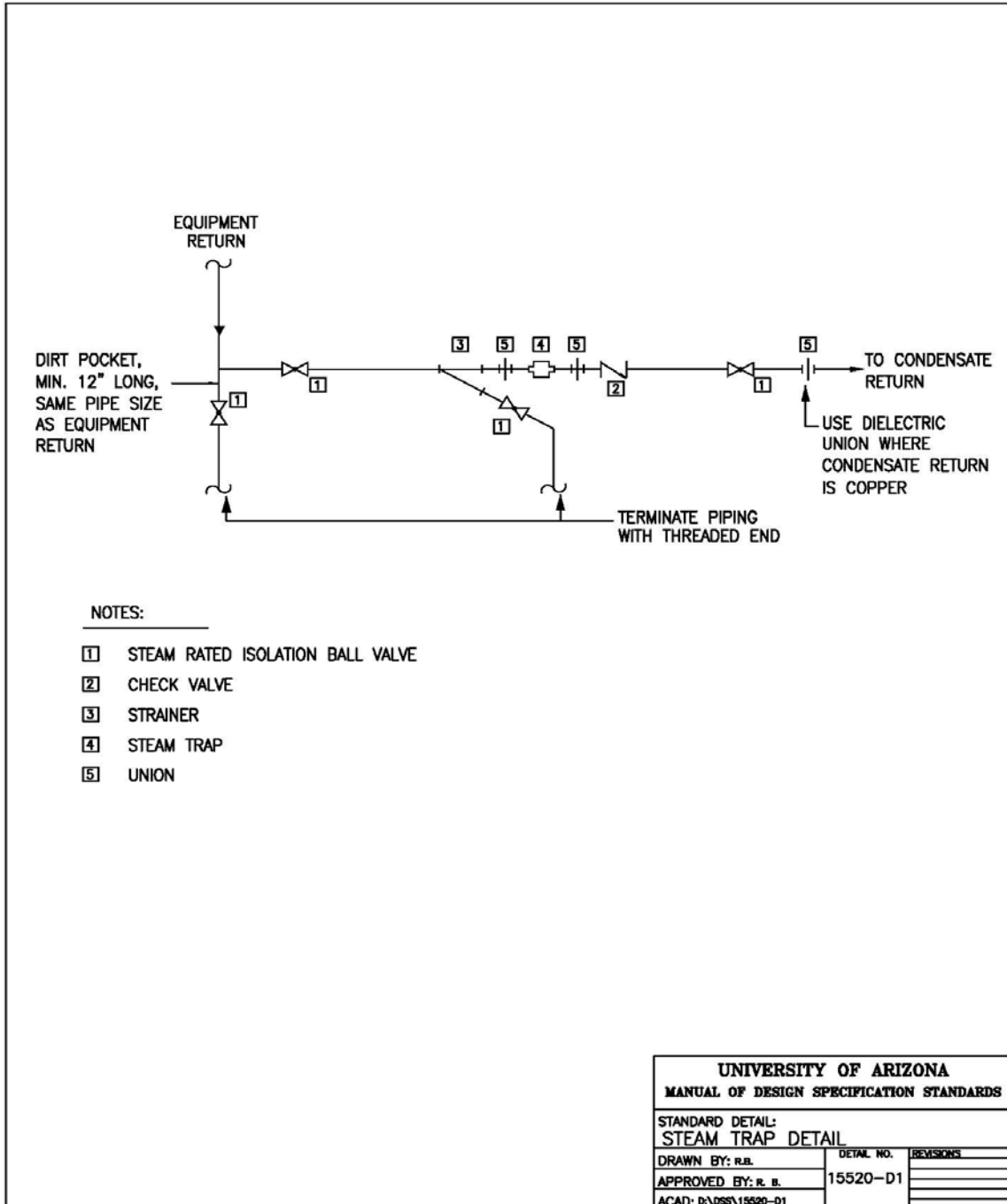

End of Section 15520



## DIVISION 15 - MECHANICAL

### Section 15530 - Refrigerant Piping and Specialties

#### Introduction

Piping and specialties associated with:

#### REFRIGERANT SYSTEMS

#### Part 1 - General

- Do not use pre-charged line sets (e.g. Aero Equip.)

#### Part 2 - Products

- Pipe Schedule - Above grade

<u>Service</u>	<u>Size</u>	<u>Pipe</u>	<u>Fittings</u>	<u>Joints</u>
Refrigerant Piping	All	Type 'L' ACR	Wrought Copper Or Cast Brass	15% Silver Solder Brazed

- Pipe Schedule - below grade

<u>Service</u>	<u>Size</u>	<u>Pipe</u>	<u>Fittings</u>	<u>Joints</u>
Refrigerant Piping	All	Type "K" ACR	Wrought Copper or Cast Brass	15% Silver Solder Brazed

- Use long radius fittings only

#### Part 3 - Execution

- Workmanship
  - Install per ASHRAE standards
- Installation
  - Provide isolation valves between split system components.
  - Provide nitrogen purge during soldering.
  - The U of A reserves the right to cut into any two fittings to confirm the use of nitrogen purge.
  - Support piping every 6 feet.
  - Provide line size trap every 25 feet of vertical lift.
  - Provide a liquid line filter drier before any expansion valve.
  - Provide suction line filter drier before compressor.
  - Provide Shraeder valves on suction and liquid line and across filter driers.

#### End of Section 15530

## **DIVISION 15 - MECHANICAL**

### **Section 15540 - Heat Transfer Equipment**

#### **Introduction**

Equipment associated with:

HVAC HEAT TRANSFER SYSTEMS INCLUDING: WATER COILS, PLATE AND FRAME HEAT EXCHANGERS, COOLING TOWERS, AND AIR WASHERS.

Pumping equipment including the following types: vertical in-line circulating pumps, base mounted pumps.

#### **Part 1 - General**

- Discuss heat exchanger type selection with UA Facilities Design & Construction.
- Design to account for water fouling factor in equipment selection.
- See water treatment section for related requirements.
- Coil Section
  - Select cooling towers at 76°F wb ambient.
  - Consider high dewpoint outside conditions when sizing cooling coils.
  - Select cooling coils with water temperatures of 44°F EWT/62°F LWT (summer) and 50°F EWT/62°F LWT (winter). Differential pressure: 15 psi minimum, 50 psi maximum.
  - Select heating coils with a 42°F water temperature differential.
  - Maximum coil face velocity 400 fpm.
  - Maximum coil pressure drop 0.5" SP.
- Vertical in-line pumps are preferred with one pump as standby for building systems. Avoid base mounted pumps when possible.
- Use premium efficiency motors. See Section 15050.
- Evaporative cooling in AHUs shall be accomplished by fixed cell Munters Fill Glasdek. Do not use water wheels.
- Adequate space and provisions shall be left for removal of coils and servicing of equipment, with minimum inconvenience to the operation of systems.

#### **Part 2 - Products**

- Hydronic coils
  - To have bottom water supply and top return.
  - Use 5/8" minimum coil tube size.
- Vertical In-Line Pumps:
  - Preferred manufacturers; Grundfos, Bell & Gossett, Armstrong, Taco, Paco, Scott

### **Part 3 - Execution**

- Provide full port ball type isolation valves close to equipment.
- Provide single pressure gauge indication with pressure snubber for each system component.
- Provide thermometer temperature indication for each line of each component.
- Provide Weld-o-lets installed for future monitoring on each line.
- Provide system strainers on inlet water side(s) of all coils and plate and frame heat exchangers.
- Coils shall be piped with water counterflow to coils. See coil detail.
- Comply with manufacturers recommended free air space for cooling towers.
- Provide manufacturer recommended clearances for maintainability.
- Provide coil and plate and frame heat exchanger blowdown sized at 1/3 of pipe size but not less than 1/2" on all sides of heat exchangers with full port ball valve. (See attached diagram.)
- Provide air vent on return pipe near high point with manual air vent (1/2" ball valve minimum) for all coils and plate and frame heat exchangers.

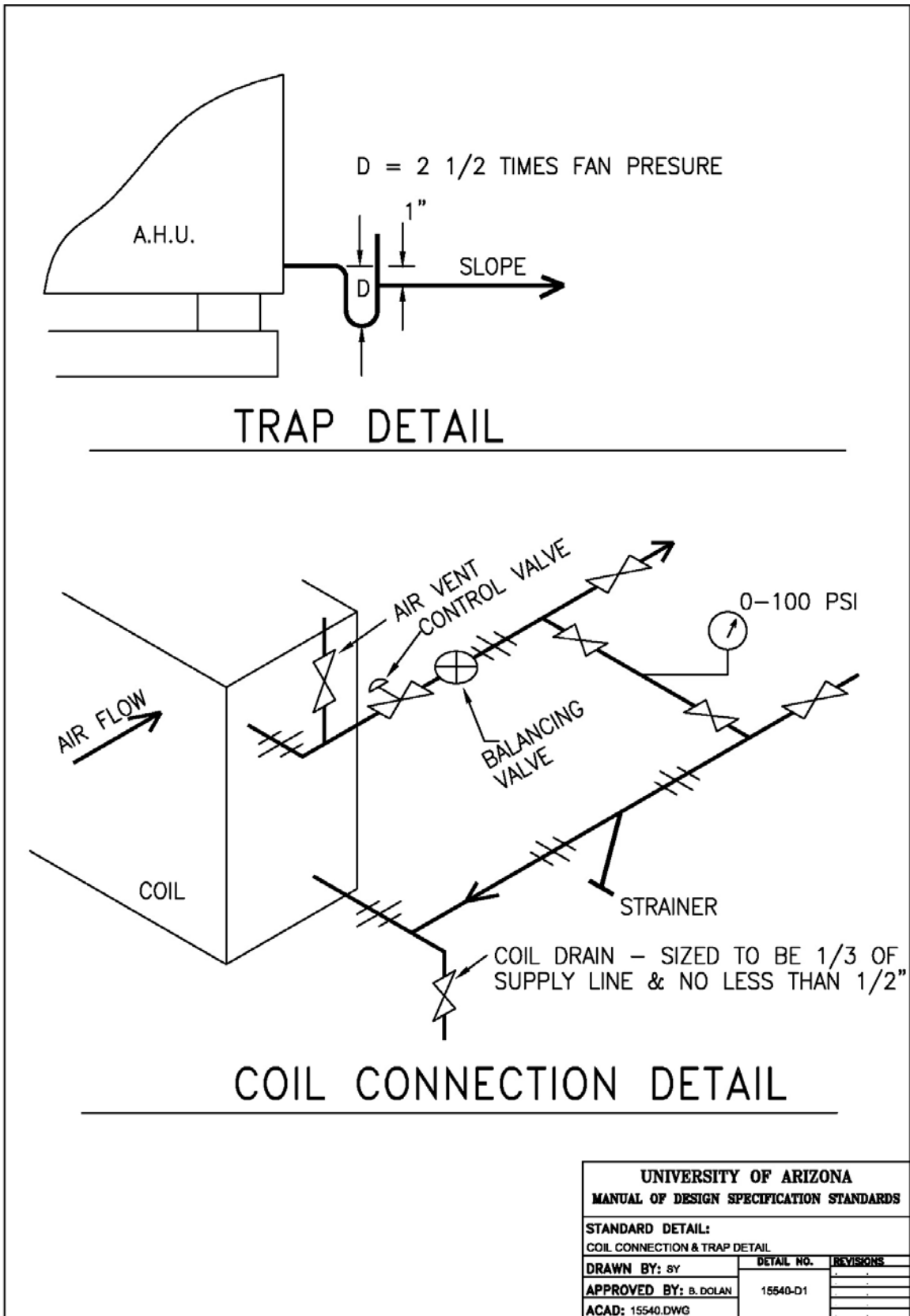

<b>UNIVERSITY OF ARIZONA</b>		
<b>MANUAL OF DESIGN SPECIFICATION STANDARDS</b>		
<b>STANDARD DETAIL:</b>		
COIL CONNECTION & TRAP DETAIL		
<b>DRAWN BY:</b> sy	<b>DETAIL NO.</b>	<b>REVISIONS</b>
<b>APPROVED BY:</b> B. DOLAN	15540-D1	
<b>ACAD:</b> 15540.DWG		

End of Section 15540

## **DIVISION 15 - MECHANICAL**

### **Section 15550 - Heat Generation**

#### **Introduction**

Heat generation equipment including:

BOILERS, FURNACES, FUEL FIRED HEATERS – Discuss all proposed installations with UA Facilities Design & Construction.

#### **Part 1 - General**

- Boilers, furnaces and fuel fired heaters shall be natural gas.
- Provide equipment schedule and piping schematics for installation of boilers, furnaces, and fuel fired heaters.
- Provide access for service of equipment in accordance with code and manufacturer recommendations.
- Conform to ASHRAE 15, Safety Code for Mechanical Refrigeration, when designing a boiler installation.
- Outside air reset shall be: 80°F water when outside air is 80°F, to 140°F water when outside air is 30°F.

#### **Part 2 - Products**

- Boilers
  - Preferred manufacturers are Parker and Weil McLain.
  - Boiler shall be a packaged unit with a minimum efficiency of 85%.
  - Boilers shall come with low water cutoff (manual reset), dual aquastat high limit control with manual reset, remote aquastat, outside air reset, gas cock, gas pressure regulator, 100% flame safeguard with manual reset, control panel.
- Furnace
  - Preferred manufacturers are Carrier, Rheem, and Trane.
  - Furnace shall be a packaged unit with an efficiency of more than 80%.
  - Furnace shall come with control relay for air conditioning.
  - Furnace shall come with high static pressure blower.
  - Heat exchangers shall have a minimum of 20 year warranty.

#### **Part 3 - Execution**

- Provide temperature and pressure gauges, and expansion tank for boilers.

#### **End of Section 15550**

## **DIVISION 15 - MECHANICAL**

### **Section 15680 - Packaged Liquid Chillers**

#### **Introduction**

Air and water cooled chillers up to 100 tons – Discuss all proposed installations with UA Facilities Design & Construction.

#### **Part 1 - General**

- Equipment room - design room within existing codes, EPA regulations and ASHRAE design standards, in particular ASHRAE 15 including the separation of refrigerant and combustion equipment and provision of alarms.

#### **Part 2 - Products**

- Acceptable manufacturers: Trane, Carrier, York, McQuay.
- Unit Description
  - Liquid chillers can be semi hermetic or scroll compression design. Separate refrigerant circuits shall include the following: liquid line solenoid valve, filter dryer, sight glass, thermostatic expansion valve and service valves.
  - Unit efficiency shall meet ASHRAE 90.1
- Evaporator
  - Shell and tube design manufactured in accordance with ASME standard, fully insulated and equipped with a drain connection.
- Condensers
  - Copper tube aluminum fin pressure tested to ASHRAE standards. Provide head pressure control.
- Electrical
  - All electric installations shall comply with the latest NEC standard. Include motor starters with equipment.
- Controls
  - All equipment shall be complete with leaving water control and unloading capability, low/high pressure switches, low ambient, freeze stat, flow switch and motor overload safeties, low oil pressure safety switches.
- Receivers
  - Shall be capable of entire refrigerant charge pumpdown.
- Head Pressure / Load Control
  - Shall be capable of running in low load and low ambient conditions. Provide compressor cylinder unloading where applicable.

- Refrigerant
  - Use HFC refrigerants. Do not use CFC or HCFC.

### **Part 3 - Execution**

- Remote Interface - provide interface with building/campus energy management system for alarms, start/stop, status, water temperatures.
- All systems are to be dehydrated, leak tested charged and tested for proper control and operation.

**End of Section 15680**

## **DIVISION 15 - MECHANICAL**

### **Section 15780 - Packaged Air Conditioners**

#### **Introduction**

Equipment associated with air conditioning systems including:

PACKAGED ROOFTOP AIR CONDITIONERS; SPLIT SYSTEM AIR CONDITIONERS; SINGLE PACKAGE HEAT PUMP; GAS/ELECTRIC AIR CONDITIONERS.

#### **Part 1 - General**

- All equipment shall comply with ASHRAE 90.1
- Packaged units shall be 100% factory run tested and fully charged.
- Cooling capacity ratings shall be based upon ARI and DOE test requirements.
- Size condensers for 115°F ambient temperature.
- Size evaporators for 80°F db/67°F wb indoor conditions unless Project requirements are different.
- Provide filters with a MERV of 8 or higher.

#### **Part 2 - Products**

- Heat Pumps
  - Provide minimum of 5kW strip heat for defrost mode where applicable.
- Roof Top Units
  - Provide filters in return ductwork or return grilles.
  - Maximum filter face velocity shall not exceed 400 fpm.
- Fans and Motors
  - Where available, specify belt driven fans with adjustable motor sheaves.
  - Use permanent split capacitor EPAC premium motors. See Section 15050.
- Gas Fired Heating Sections
  - Minimum of 20 year warranty.
- Compressors
  - Use R-22 or HFC refrigerant.
  - Use semi hermetic compressors on units of 5 tons or greater.

#### **Part 3 - Execution**

- Install per manufacturer stated clearances.
- Condenser clearances to obstructions to be a minimum of 2 feet or as per manufacturer recommendations.



- Provide 3 feet clearance around rooftop units or remote condensing units.
- Provide maintenance access to all equipment requiring service.

**End of Section 15780**

## **DIVISION 15 - MECHANICAL**

### **Section 15810 - Humidifiers**

#### **Introduction**

Equipment associated with air conditioning equipment.

#### **Part 1 - General**

- Provide only when absolutely necessary or when a special Project requirement.
- Discuss with UA Facilities Design & Construction.

#### **End of Section 15810**

## **DIVISION 15 - MECHANICAL**

### **Section 15840 - Ductwork**

#### **Introduction**

Ductwork Systems including:

METAL DUCTWORK, FLEXIBLE DUCTWORK, EXHAUST DUCTWORK.

#### **Part 1 - General**

- All exhaust ductwork within the building shall be under negative pressure. Exhaust ductwork connections to equipment shall allow for proper drainage flow. Fumehood exhaust ductwork can be manifolded only if multiple exhaust fans are used.
- Special applications of products other than those listed must be submitted to U of A for consideration.
- Restrict use of duct liner as per Section 15250 requirements.
- Ductwork downstream of air handling units shall be constructed in accordance with 100% effective duct length as per ASHRAE and latest SMACNA standards.
- Use single thickness turning vanes only in ductwork up to 2" pressure class. Install per SMACNA.
- Do not use turning vanes in reducing elbows.
- Utilize 45° branch duct entries with main duct size reduction downstream for medium and high velocity systems.
- Utilize 45° branch duct entries or full conical taps for low pressure ductwork. No Bellmouth, Flanged or Notch Spin-In connections permitted except at terminal/diffuser take-offs.
- No extractors allowed.
- Exhaust system designs shall conform to AIHA Industrial Ventilation manual.
- Design with 15° convergence and divergence preferred. Absolute maximum of 30° divergence or 45° convergence.
- Use Pittsburg construction on longitudinal seams. Button punch snaplock construction is not acceptable.

#### **Part 2 - Products**

- Galvanized Steel shall be ASTM A 527, G90 of lock forming quality.
  - Heating & cooling supply and return, non-chemical exhausts – minimum 24 gauge.
- Stainless Steel shall be ASTM A 240, type 316
  - Spiral or welded for fumehood applications. Fittings shall be continuously welded – liquid tight.
  - All welded seams for perchloric applications.
- Coated Galvanized Steel

- Under special circumstances, with U of A permission, coated galvanized steel ducts may be used for manifolded general chemical exhaust plenums which are large enough to allow duct internal inspection and repair of coating.
- Flexible Ductwork
  - Ductwork to be constructed in accordance with NFPA 90A, 90B, UL181 Class 1.

### **Part 3 - Execution**

- Chemical exhaust ductwork to conform with ANSI/AIHA standard 29.5 - 1992
- Ductwork to be constructed per latest SMACNA HVAC Duct Construction Standards.
- High pressure flexible ductwork shall not be used for changes in direction.
- Low pressure flexible ductwork may only be used to accommodate a total of a 45° change in direction. Hard elbows shall be used at diffusers.
- Flexible ductwork shall be secured utilizing steel draw-band clamp.
- Maximum flexible ductwork lengths - 18" on high pressure systems, 48" on low pressure systems.
- Use center radius of 1.5 times duct width (minimum) on tees, bends, elbows.
- Use Hardcast AFG-1402 Foil-Grip tape, Hardcast DT-Tape with FTA-20 adhesive, or water based paint-on duct sealant for indoor use, or RTA-50 adhesive for outdoor use, to seal all duct joints.
- Ductwork shall be stored in a clean location prior to installation. Openings shall be covered to prevent entry of dust, moisture and general construction dirt/debris. Plastic sheeting securely taped over open ends will be acceptable.
- Provide balancing dampers at all branch ducts.

### **End of Section 15840**

## **DIVISION 15 - MECHANICAL**

### **Section 15850 - Ductwork Accessories**

#### **Introduction**

Equipment associated with:

AIR HANDLING SYSTEMS INCLUDING TERMINAL BOXES.

#### **Part 1 - General**

- Terminal Box test submittal data shall be in accordance with ADC/ARI Standard 880-89.
- Terminal Box fittings in pneumatic lines to be brass barbed type complete with rubber caps if needed.
- Terminal Box controllers to be compatible with Campus EMCS. (*See Section 15970*)
- Minimum press drop across Terminal Box to be 0.1" wg with control damper fully open.
- Terminal Boxes shall have screwed access doors if serviceable items are enclosed.
- Do not reuse existing Terminal Boxes when designing a space remodel.
- Terminal Box damper leakage shall not exceed 2% of nominal box rating at 4" static pressure.
- All Terminal Box controls shall be externally mounted.
- Fire dampers to be installed in accordance with manufacturers installation instructions.

#### **Part 2 - Products**

- Use only 'long' terminal boxes for any air volume control application requiring accuracy greater than +/- 25%.
- Pneumatic terminal box volume reset controller to be Johnson Controls type P3800 or UA approved equal.

#### **Part 3 - Execution**

- Install terminal boxes with minimum of 18" clearance access for service and maintenance.
- Allow sufficient pneumatic tubing at volume reset controller to form 3" radius.  
Do not draw tubing tight or flatten cross-sectional area.

**End of Section 15850**

## **DIVISION 15 - MECHANICAL**

### **Section 15855 - Air Handling Systems**

#### **Introduction**

Equipment associated with:

CENTRAL STATION AIR CONDITIONING AND DISTRIBUTION.

See related Sections           15540 Heat Transfer Equipment  
  15860 Fans  
  15885 Filters

#### **Part 1 - General**

- *Preferred system design based on Dual Duct VAV Concept complete with dual fans. Discuss all system selections with UA Facilities Design & Construction.*
- AHU to be 'draw-thru' type.
- Size AHU to meet latest edition of ASHRAE Standard 62-1989.
- In new construction utilize AHU to 'flush' building to reduce off-gasing of interior furnishings prior to occupancy. Fit AHU with temporary filters during this period.
- Replace filters before system balancing.
- Preferred location of OA intakes is above roof level - not ground level. However, avoid location of AHU outside air intake in vicinity of plumbing vent stacks, emergency generator stacks, loading dock areas and areas where people might congregate to smoke cigarettes.
- OA intakes to be hard ducted through Mech. Rooms unless a separate AHU room is provided.
- Ensure access is provided to both sides of AHU fans to allow bearing replacement.
- Ensure smooth, uniform inlet and discharge flow conditions to and from AHU.
- Provide 'minimum' of one fan impeller diameter upstream of fan.
- Ensure flexible connections are taut.
- Provide vibration safety switches on all Vane Axial type fans.
- When Vane Axial fans are used ensure suitable access is provided for servicing/removal.
- Control valves shall be located outside of air handler enclosure.

#### **Part 2 - Products**

- Provide hinged access doors to both sides of coils, fans, filters and damper sections.
- Provide removable side panels in fan sections to allow for fan and shaft removal/replacement.
- AHU shall not be constructed using porous or semi porous materials.

- AHU shall be double walled casing - minimum 18 gauge.
- AHU shall have interior inspection lights.
- Large AHU to have inspection windows in access doors.
- Utilize only 'premium efficiency' motors in AHU's. See Section 15050.

**Part 3 - Execution**

- Ensure coil drain pans and condensate pipework is pitched to drain, (minimum pitch ¼" per foot).

**End of Section 15855**

## **DIVISION 15 - MECHANICAL**

### **Section 15860 - Fans**

#### **Introduction**

Fan systems including:

SUPPLY, RETURN AND EXHAUST AIR SYSTEMS.

#### **Part 1 - General**

- Short coupled, multi-belted fans to utilize companion sheaves in lieu of variable pitched sheaves.
- Provide vibration switch on fan.
- Fan RPM to be 1200 - 1400 (except exhaust fans).
- Max RPM for exhaust fans not to exceed 1800.
- Fans to be tested in accordance with ANSI/ASHRAE STD 51 and ANSI/AMCA STD 210.
- Centrifugal fans handling more than 1,000 CFM shall have backward inclined blades.
- Fans shall be statically and dynamically balanced at the factory.
- Standard Products - use same manufacturer for multiple installations for the same type.
- *Preferred* manufacturers; Greenheck, Loren Cook, ILG, Trane.
- Permanently lubricated bearings are not acceptable.
- Bearings shall be heavy duty split pillow block, self-aligning ball bearings with seals and grease nipples, minimum service life of 200,000 hrs.
- Provide drain connection in bottom of fan housing - minimum size 3/4".
- Provide access doors to blower section - minimum size 18" x 18".
- Provide weather-proof package for any fan located outdoors.
- Utility fans serving fume hoods shall have minimum velocity of 3000 f.p.m. at stack discharge.
- Min. height of discharge stack to be 10'.

#### **Part 2 - Products**

- Don't use VFDs on forward curved fans.

#### **Part 3 - Execution**

- No discussion.

#### **End of Section 15860**



## DIVISION 15 - MECHANICAL

### Section 15870 – Variable Frequency Drives

#### Introduction

This specification is to cover a complete variable frequency motor drive (VFD) consisting of a pulse width modulated (PWM) inverter output waveform (VVI, six-step, and current source drives are not acceptable) designed for use on a standard NEMA Design B induction motor. The VFD shall employ a 1600 volt full wave bridge rectifier, 5% impedance AC or DC Line Reactor, EMI/ RFI filters, capacitors, and Insulated Gate Bipolar Transistors (IGBT's) as the output switching device.

The drive manufacturer shall have a representative exclusively for HVAC products, both sales and service will be the same organization for sole source responsibility.

#### Part 1 - General

- Quality Assurance
  - Referenced Standards
    - Institute of Electrical and Electronic Engineers (IEEE) Standard 519-1992, IEEE Guide for Harmonic Content and Control.
    - Underwriter Laboratories: UL508C
    - National Electrical Manufacturer's Association (NEMA) ICS 7.0, AC Adjustable Speed Drives.
    - IEC 16800 Parts 1 and 2.
  - Qualifications
    - VFD's and options shall be UL listed as a complete assembly. VFD's that require the customer to supply external fuses for the VFD to UL listed are not acceptable. The base VFD shall be UL listed for 100 KAIC without the need for input fuses.
    - CE Mark- European Union Electro Magnetic Compatibility directive, a requirement for CE marking. The VFD shall meet product standard EN 61800-3 for the First Environment restricted level.
    - Acceptable Manufactures- ABB ACH Series, 550.
    - Substitutions must have Consulting (Mechanical/Electrical) Engineer written approval 2 weeks prior to date of bid. Written approval does not relieve supplier of specification requirements. All exceptions to this specification shall be submitted in writing to the Consulting Engineer at that time.
    - All VFD's shall be provided by the authorized local Rep/Distributor and be of one manufacturer. All HVAC OEM'S (AHU, Pumps, Cooling towers, etc.) shall allow VFD's to be shipped to factory for mounting or HVAC OEM units are to be deigned to interface/accommodate field mounting of VFD's.
    - All VFD's that are manufactured by a third party and "brand labeled" shall not be acceptable.
- Submittals
  - Submittals shall include the following information
    - Outline dimensions, conduit entry locations and weight, customer connection and power wiring diagrams, technical product description include a complete list of options provided.
    - Compliance to IEEE 519- harmonic analysis for particular jobsite including total harmonic distortion (BOTH VOLTAGE and TDD). Using job specific electrical information the VFD manufacturer shall provide calculations showing toal harmonic voltage distortion, is less than 5% at point of common coupling. Input line filters shall be sized and provided as required by the VFD manufacturer to ensure compliance with IEEE standard 519. All VFD's shall include a minimum of 5 % impedance reactors, **no exceptions**.

#### Part 2 – Products

- Variable Frequency Drive
  - The VFD shall be listed ISO9001 and the package as specified herein shall be enclosed in a UL listed Type 1, 12 (indoor enclosures) or 3R (outdoor enclosure) as applicable/specified.
  - The VFD tolerated voltage window shall allow the VFD to operate from a line of +30% nominal, and -35% nominal voltage as a minimum.
    - Environmental operating conditions: -15 to 40°C to (5 to 104°F) ambient temperature continuous with no current de-rate. From 40°C (104°F) to 50°C (122°F) ambient temperature range, VFD current de-rate will not be greater than 10% and not exceed a rate of 1% current de-rate per 1°C or VFD must be oversized. VFD's that can operate at 40°C intermittently (during a 24 hour period) are not acceptable and must be oversized. Altitude 0 to 3300 feet above sea level, less than 95% humidity, non-condensing. Enclosure shall be UL listed as a plenum rated VFD. VFD's without these ratings are not acceptable.
  - All VFD's shall have the following standard features:
    - All VFD's shall have the same digital keypad, shall be removable, capable of remote mounting and uploading and downloading of parameter settings for start-up of multiple VFD's.
    - The keypad shall include Hand-Off-Auto selections and manual speed control. The drive shall incorporate "bumpless transfer" of speed reference when switching between "Hand" and "Auto" modes.
    - There shall be a built-in time clock in the VFD keypad. The clock shall have a battery back up with 10 years minimum life span. The clock shall be used to date and time stamp faults and record operating parameters at the time of fault. The clock shall also be programmable to control start/stop functions, constant speeds, PID parameter sets and output relays, four (4) separate, independent timer functions that have both weekday and weekend settings.
    - The VFD's shall utilize pre-programmed HVAC application macro's specifically designed to facilitate start-up.
    - The VFD shall have cooling fans designed for replacement without requiring removing the VFD from the wall or removal of circuit boards.
    - The VFD shall be capable of starting into a coasting load (forward or reverse) up to full speed and accelerate or decelerate to setpoint without safety tripping or component damage (flying start).
    - The VFD shall automatically restart after an over-current, over-voltage, under-voltage, or loss of input signal.
    - The overload rating of the drive shall be 110% of its normal duty current rating for 1 minute every 10 minutes, 130% overload for 2 seconds. The minimum FLA rating shall meet or exceed the values in the NEC/UL table 430-150 for 4-pole motors.
    - The VFD shall have integral 5% impedance line reactors to reduce the harmonics to the power line and to add protection from AC line transients. The 5% impedance may be from dual (positive and negative DC bus) reactors, or 5% impedance AC line reactors. VFD's with only one 5% DC reactor shall add AC line reactors.
    - The VFD shall include a coordinated AC transient protection system consisting of 4-120 joule rated MOV's (phase to phase and phase to ground), a capacitor clamp, and 5% impedance reactors.
    - The VFD shall be capable of sensing a loss of load (broken belt/broken coupling) and signal a warning or fault as required.
    - If there is a loss of the input reference the VFD shall give the user the option of either(1) stopping and displaying a fault, (2) running at a programmable preset speed, (3) hold the VFD speed based on the last good reference received, or (4) cause a warning to be issued, as selected by the user.
  - All VFD's shall have the following adjustments:
    - Three (3) programmable critical frequency lockout ranges to prevent the VFD from operating the load continuously at an unstable speed.
    - Two (2) PID Setpoint controllers shall be standard in the drive, using the microprocessor for the closed loop control. The VFD shall have 250 ma of 24 VDC auxiliary power and be capable of loop powering a transmitter supplied by others. The PID setpoint shall be adjustable from the VFD keypad, analog

inputs, or over the communications bus. The PID parameter values may be changed with a digital input, serial communications or from the keypad. There shall be an independent, second PID loop that can utilize the second analog input and modulate one of the analog outputs to maintain setpoint of an independent process (i.e. valves, dampers, cooling tower bypass valve control, chilled water valve control, etc.) and be accessible from the serial communication network. The setpoints shall be available in Engineering units.

- Two (2) programmable analog inputs shall accept current or voltage signals.
  - Two (2) programmable analog outputs (0-20ma or 4-20ma).
  - Six (6) programmable digital inputs allowing multiple safeties, run permissive circuits for damper and valve control, etc.
  - The VFD shall include a “run permissive circuit” that will provide a normally open contact whenever a run command is provided (local or remote start command in VFD or bypass mode). The VFD shall provide a dry contact closure that will signal the damper to open (VFD motor does not operate). The VFD system (VFD or bypass) shall not operate the motor until it receives a dry contact closure from a damper or valve end-switch. When the VFD system safety interlock (fire detector, freezestat, high static pressure switch, etc) opens, the motor shall coast to a stop and the run permissive contact shall open, closing the damper or valve.
  - Three (3) programmable digital Form-C relay outputs standard, expandable to (6). The relays shall include programmable on and off delay times and adjustable hysteresis. The relays shall be rated for maximum switching current 8 amps at 24 VDC or 250 VAC. Maximum voltage 30 VDC and 250 VAC with maximum continuous current rating 2 amps RMS. Outputs shall be true from C type contacts; open collector outputs are not acceptable.
  - Seven (7) programmable preset speeds.
  - The VFD shall include a motor flux optimization circuit that will automatically reduce applied motor voltage to the motor to optimize energy consumption and audible motor noise.
  - The VFD shall reduce the carrier frequency on actual VFD temperature that allows highest carrier frequency without derating the VFD
  - The VFD shall include password protection against parameter changes.
- The Keypad shall include a backlit LCD display be in complete English words for programming and fault diagnostics (alpha-numeric codes are not acceptable).
  - All applicable operating values shall be capable of being displayed in engineering (user) units. A minimum of three selectable values will be displayed in real time, in complete English words.
  - The VFD shall include a fireman’s override input. Upon receipt of a contact closure from the fireman’s control station, the VFD shall override all other inputs (analog/digital, serial communication, and all keypad commands) and force the motor to run at the adjustable, preset speed.
  - Serial Communications
    - The VFD shall have an RS-485 port as standard. The standard protocols shall be Modbus RTU, Johnson Controls N2 bus, Siemens Building Technologies FLN and BACnet available. No additional hardware, firmware, gateways, etc. shall be required for these standard protocols. Optional protocols for Lon Works, Profibus, Ethernet, and DeviceNet shall be available, and have the protocol in each VFD. The use of third party gateways and multiplexers is not acceptable. All protocols shall be “certified” by the governing authority, non-certified protocols are not allowed. If additional gateway, hardware, etc. is required to obtain the BACnet, Modbus, etc. interfaces, the VFD manufacturer shall supply one gateway, hardware device, etc. per VFD. Multiple VFD’s sharing one gateway, hardware, etc. shall not be acceptable.
    - The BACnet connection shall be an RS485, MSTP interface operating at 9.6, 19.2, 38.4 or 76.8Kbps. The connection shall be tested by the BACnet Testing Labs (BTL) and be BTL listed. The BACnet interface shall conform to the BACnet standard device type of an Applications Specific Controller (B-ASC). The interface shall support all BIBBS (BACnet Interoperability Building Blocks) defined by the BACnet standard profile for a B-ASC.
    - The drive shall have the capability of allowing the DDC (Direct Digital Control/ Building Automation System) to monitor feedback, such as process variable feedback, output speed/ frequency, etc.

monitoring the VFD relay output status, digital input status, and all analog input and analog output values. All diagnostic warning and fault information, remote VFD fault reset keypad “Hand” or “Auto” selected, bypass selected, the ability to change the PID setpoint, and the ability to force the unit to bypass(if bypass is specified) shall be transmitted over the serial communications bus. The DDC system shall also be able to monitor and start stop if the motor is running in the VFD mode or bypass mode (if bypass mode is specified).

- The VFD shall allow the DDC to control the drive’s digital and analog, inputs and outputs. For example, the analog outputs may be used to modulating chilled water valves or cooling tower bypass valves, digital (relay) outputs may be used to actuate a damper, open a valve or control any other device that requires a maintained contact for operation.
- EMI/RFI filters. All VFD’s shall include EMI/RFI filters. The onboard filters shall allow the VFD assembly to be CE Marked and the VFD shall meet product standard EN 61800-3 for the First Environment restricted level.
- Bypass – All features shall be UL listed by the drive manufacturer as a complete assembly and carry a UL508 label.
  - An output contactor, bypass, contactor and VFD only disconnect/service switch and/or fuses. Overload protection and shall be provided in both drive and bypass modes.
  - Door inter-locked, pad-lockable circuit breaker that will disconnect all input power from the drive and all internally mounted options.
  - Fused VFD only disconnect (service switch) and/or fast acting fuses exclusive to the VFD to allow the VFD to disconnect from the line prior to clearing upstream branch circuit protection, maintaining bypass capability. Bypass designs that incorporate fuses common to both the VFD and the by pass will not be accepted. Three contactor by pass schemes are not acceptable, as a VFD input contactor is not a NEC recognized, lockable, physical disconnect and is an unacceptable means of safely disconnecting power to VFD.
  - The drive/ bypass shall provide single-phase motor protection and under-voltage protection in both the VFD and bypass modes.
  - The following operators shall be provided: a. Bypass Hand-Off Auto; b. Drive mode selector; c. Bypass mode selector; d. Bypass fault reset.
  - The following indicating lights (LED type/ pilot light) shall be provided. A test mode or push to test feature shall be provided: a. Power-on(Ready); b. Run enable (safeties) open; c. Drive mode select damper opening; d. By pass mode selected; e. Drive running; f. Bypass running; g. Drive fault; h. Bypass fault; i. Bypass H-O-A mode; j. Automatic transfer to bypass selected; k. Safety open; l. Damper open; m. Damper end-switch made.
  - The following relay (form C) outputs from the bypass shall be provided: a. System started; b. System running; c. Bypass override enabled; d. Drive fault; e. Bypass fault motor overload or underload (broken belt); f. Bypass H-O-A position.
  - Customer Interlock Terminal Strip for connection of freeze, fire, smoke contacts, and external start command. The remote start/stop contact shall operate in VFD and bypass modes.
  - Dedicated digital input that will transfer motor from VFD mode to bypass mode upon dry contact closure for fireman’s override. Two modes of operation are required.
    - One mode forces the motor to bypass operation.
    - The second fireman’s override mode remains as above but will also defeat all safeties and inputs (run until destruction).
  - Class 20 or 30 (selectable) electronic motor overload protection shall be included.
  - Provide capability to select manual or automatic bypass.

### Part 3- Execution

- Installation
  - Installation shall be the responsibility of the mechanical contractor as outlined in the installation manual.
  - Power wiring shall be completed by the electrical contractor as outlined in the installation manual.

- Start-Up
  - Certified factory start-up shall be provided for each drive by a factory authorized service center. A certified start-up form shall be filled out for each drive with a copy provided to the owner, and copy kept on file at the manufacturer.
- Product Support
  - Factory trained application engineering and service personnel shall be locally available at both the specifying and installation locations. A 24/365 (24 hour/ 365 days per year) technical support line shall be available on a toll- free line.
  - A computer based training CD and 4 hour on-site training shall include installation, programming, and operation of the VFD, bypass and serial communication.
- Warranty
  - Warranty shall be 24 months from the date of certified start-up, not to exceed 30 months from the date of shipment. The warranty shall include all parts, labor, travel time and expenses. There shall be 24/365 support available via a toll free phone number.

**End of Section 15870**

## **DIVISION 15 - MECHANICAL**

### **Section 15885 - Filter**

#### **Introduction**

Filtration systems associated with AHU and FCU's.

#### **Part 1 - General**

#### **Part 2 - Products**

#### **Part 3 - Execution**

**End of Section 15885**

## Division 15 Mechanical

### Section 15970 - Control Systems

#### Introduction

Equipment associated with:

THE MANAGEMENT OF HEATING, VENTILATION, AND AIR CONDITIONING RELATED UTILITIES.

#### Part 1 - General

- The Energy Management Control System shall be Direct Digital Control, fully automatic, with electric and pneumatic components as required. All actuation within mechanical rooms and major air handling units shall be pneumatic. Electric actuation can be used if better performance will result. Discuss with U of A, Facilities.
- All terminal boxes, sensors and actuators shall be electronic / electric.
- System design shall be stand alone and of modular fashion to insure future expansion capabilities, whether it be additional control / monitoring points or supervisory functions.
- System shall have a minimum of 10% capacity expansion within the current equipment.
- Monitor all central utilities and emergency systems from a local and remote location.
- Metering devices to be installed per design guidelines Section 15980.
- Provide industrial linear-type chilled water pressure control valve as required by U of A, at tunnel entrance to maintain system pressures within the building.
- Provide electronic speed control for variable volume systems.

#### Part 2 - Products

- Controls must completely interface with the *Campus* existing Barber Colman/Siebe or Johnson Controls systems without added expense.
- *The direct digital control system shall be directly connected to the Owner's campus-wide EMCS via the EtherNet.*
- *Controls shall be microprocessor based interoperable LONMARK controllers bearing the applicable LONMARK interoperability logo on each product provided.*
- *LonTalk communications protocol will be utilized on the dedicated building communication network between EMCS controllers and other LonWorks devices to assure interoperability between all devices within the building network.*
- *The EMCS shall provide the direct integration of standard BACnet.*
- *The EMCS shall provide Ethernet communication in compliance with the ASHRAE standard 135-P for BACnet.*
- Noise, surge and spike protection: Kele model # HSP-121-B
- Shall be capable of withstanding power outages and surges for extended periods of time.
- Memories shall be non-volatile , or unit shall hold memory up to 30 days minimum on backup batteries.

- All CV and VAV terminal units controls shall be DDC "smart type" for new building construction.
- Use Fisher 92B steam pressure reducing valve with the appropriate pilot.
- Use manual reset freeze stats.
- Humidity sensors: OMEGA-HX-93C.

### Part 3 - Execution

- Supply the following monitoring and control features where applicable:
  - Building Systems  
Complete utility usage (water, steam condensate, chilled water, electric)
  - Utility Usage  
Chilled water flow in GPM, totalized energy in BTU's  
Hot water flow in GPM, totalized energy in BTU's  
Steam condensate flow in lbs./hr., totalized energy in lbs.  
Domestic water totalized in gallons  
Electric use totalized in kW hrs., real time demand in kW  
  
Individual equipment power and energy use where required by U of A  
Chilled water supply and return pressure and temperatures  
Steam pressures  
Domestic water pressures  
Hot water supply and return pressure and temperatures  
Status of equipment pumps and drives  
Change of set point capability for all variable frequency drives  
Provide HVAC equipment greater than 1 hp with time scheduling capability, i.e., time clocks  
Reset of hot water supply temperatures  
Chiller operational status, run times, pressures and temperatures  
Cooling tower operational status and temperatures  
Report of any EMCS component failures on critical equipment as required by U of A  
Emergency generator-run time, load, kW, kVA  
Alarms as specified in other sections  
Outside air temperature
  - Individual Unit Characteristics  
Air Handler status, start / stop  
Supply, Return and Mixed air temperatures  
Reset of hot and cold decks  
Economizer control  
Chilled water return temperature control  
Lighting controls where specified  
Filter differential pressure indication  
Air humidity status and reset when specified, high limit control.  
Status of Hot and Cold duct static pressure  
Active control strategy for maintaining outdoor air requirements, e.g, CO<sub>2</sub> sensing.
- Provide airflow measuring stations as required.
- All control valves and isolation valves are to be located outside the Air Handler enclosure.



- Chilled water control valves to fail to “open” position. Hot water control valves to fail to “closed” position.
- Provide adequate space to install all control valves with stems in the vertical position without exception.
- Provide adjustable static pressure safety switch to shut down VFD controlled fans.
- Identify all controls and wiring within pertinent control panel and provide control system drawing framed under plexiglass on inside of panel door.

**End of Section 15970**

## **DIVISION 15 - MECHANICAL**

### **Section 15980 - UTILITY METERS**

#### **Introduction**

Meters are required on chilled water, steam condensate, and domestic water.

#### **Part 1 - General**

- Design, specify, furnish, install, and commission all utility meters required and owned by University.
- Utility meters shall be designed and specified by the project consulting engineers. Project contractor shall furnish and install all utility meters. Utility meter commissioning shall be a joint effort between the project contractor and the project consulting engineers and The University of Arizona. The University will not accept any utility meter until it has been shown to be fully functioning and operational.
- Design shall include selecting, scheduling, and specifying each utility meter as would be done for any piece of specialized equipment.
  - Flow Meters shall be selected to handle the flow range they will encounter at present design conditions.
    - Meters shall be connected to the University's campus SCADA C3 system thru the Modbus gateway (FieldServer X-40 included in section App-16720 of the UA Design Specifications Standards manual) and shall be capable of fully monitoring the building energy and water usage. Meters shall be connected to the University EMCS thru the LON connection on the Modbus gateway. See the UA Manual of Design Standards Section 15970 and Drawing # 16720-D2 for further requirements.
    - The meter shall be selected with Modbus RTU output.
    - All meters, transducers and RTD's will be non intrusive.
    - Project control drawings and specifications shall include all the information, including, but not necessarily limited to, points, termination, and programming necessary to provide complete building energy use reporting on the University's EMCS.
    - University of Arizona shall assist in reviewing the project contractor's utility metering submittal.
    - Project drawings and specifications shall include the following utility meter information as a minimum:
      - Domestic Water, Chilled Water, and Steam Condensate, Meters:
        - Type of service (i.e., chilled water, steam condensate, or domestic water).
        - Size of meter, manufacturer, type, model number.
        - Location of meter, sensors, and remote readouts.
        - Meter shall be located, including dimensions of installation if a specific location is necessary for proper operation.
        - Meter or meter remote readouts shall be readily accessible and at a level (5'6") that can be read without using a ladder.
    - Accuracy and Repeatability to meet federal guidelines for billable meter requirement.
  - Domestic Water, Chilled Water, and Steam Condensate Meters:
    - Range: maximum flow, minimum flow, and normal flow expected at present design conditions.

- Installation details: details shall be complete and include all necessary information, including, but not limited to, length of straight pipe required upstream and downstream, distance required from valves or fittings, any required concentric reducers and location of temperature and pressure sensors.
- Chilled Water Meters:
  - All items necessary to allow the chilled water flow sensors to function as energy meters shall be specified and shown on the drawings and included in installation details.
  - Output of energy meter shall be in BTU's and totalized in MBTU's.
  - These additional items shall include, but are not limited to, temperature sensors, BTU totalizing computer, connection requirements to the campus SCADA C3 system at the Modbus gateway with a Lon connection from the University EMCS system, programming requirements and software.
  - Delta temperature transmitters shall be platinum 1000 OHM RTD, Where 1000 ohms equals 32<sup>0</sup>F.
  - Delta temperature sensors shall be matched pairs of calibrated sensors with an accuracy of 0.12° F.
  - Flow transducers shall be selected for the expected flow range encountered at present design conditions, pipe size and material. Particular attention shall be made to low flow conditions.
  - For all installations an energy totalizing computer will be required.
- Steam Condensate Meters:
  - All items necessary to allow the steam condensate flow sensors to be fully functional shall be specified and shown on the drawings and included in installation details.
  - Output of energy meter shall be in BTU's and totalized in MBTU's.
  - These additional items shall include, but are not limited to, flow (in MBTU's) totalizing computer, connection requirements to the campus SCADA C3 system at the Modbus gateway with a LON connection from the Modbus Gateway to the University EMCS system, programming requirements and software.
  - Delta temperature transmitters shall be platinum 1000 OHM RTD, Where 1000 ohms equals 32<sup>0</sup>F.
  - Delta temperature sensors shall be matched pairs of calibrated sensors with an accuracy of 0.12° F.
  - Flow transducers shall be selected for the expected flow range encountered at present design conditions, pipe size and material. Particular attention shall be made to low flow conditions.
  - For all installations an energy totalizing computer will be required.

## **Part 2 - Products (UTILITY METER REQUIREMENTS) – Discuss With UA Facilities Design & Construction**

- Domestic Water Meter:
  - Shall be clamp-on ultrasonic flow meter, Metron flow meter with 1180 series BUM, Siemens SITRANS FUS1010, or approved equal.
  - Meters shall read in gallons and totalized in KGAL.
  - Water meters shall have a local readout as well as Modbus output to report to the Campus SCADA C3 system and thru a LON connection from the Modbus Gateway to the University's EMCS system.
- Chilled Water flow sensor:
  - Shall be clamp-on ultrasonic energy meter, Metron flow meter with 1180 series BUM, Siemens SITRANS FUE1010, or approved equal.
  - Where an energy totalizing computer is required, it will use the Modbus RTU protocol for output
  - Flow transducers shall be combined with supply and return temperature sensors.
  - Transducers and temperature RTD's will be factory calibrated matched sets.
  - Meters shall be capable of local or remote reading within the building close to the meter location.
  - Provide a Modbus RTU output to the Campus SCADA C3 system Modbus gateway; from the Modbus gate way provide a LON connection to the University's EMCS.

- Condensate Meter:
  - The steam condensate meter shall be a clamp-on ultrasonic energy meter, Metron flow meter with 1180 series BUM, Siemens SITRANS FUE1010, or approved equal.
  - Where an energy totalizing computer is required, it will use the Modbus RTU protocol for output
  - Flow transducers shall be combined with supply and return temperature sensors.
  - Transducers and temperature RTD's will be factory calibrated matched sets.
  - Meters shall be capable of local or remote reading within the building close to the meter location.
  - Provide a Modbus RTU output to the Campus SCADA C3 system Modbus gateway; from the Modbus gate way provide a LON connection to the University's EMCS.

### **Part 3 – Execution**

- The supply of any utility to a building shall not be activated until the specified metering is in place, functional, and has been commissioned.
- During the final phase of the project and before final close out, project contractor shall be required to prove that all utility meters are installed properly and function as designed and specified. The utility meter commissioning shall be accomplished by the contractor in conjunction with the project consulting engineers and The University of Arizona.
  - Require calibration data, O & M manuals, details, etc., to be submitted after meters accepted.

### **End of Section 15980**

## DIVISION 15 - MECHANICAL

### Section 15990 - Testing, Adjusting And Balancing

#### Introduction

Achieving an acceptable final air and water balance is one of the most critical elements of project completion. It is therefore extremely important that the balancing and the associated report be accomplished and submitted before or at the time of substantial completion. Similarly, timely reviews by the Consultant/UofA will insure that the final balance is acceptable prior to occupancy.

#### Part 1 – General

- Vibration Testing
  - Vibration testing to be performed on all rotating equipment 3 horsepower and above in accordance with AABC Standards.
  - Equipment shall have a maximum vibration velocity reading no greater than 0.04in/sec.
- Fume Hood Testing *Discuss With UA Facilities Design & Construction*
  - Each fume hood shall be identified with a plaque indicating the location and number of exhaust fan serving the hood.
  - Each exhaust fan shall be identified with a weather-proof plaque indicating the location(s) of the fume hood(s), by room number, that the fan serves.
- Air Systems
  - All work shall be in accordance with latest edition AABC, NEEB Standards and applicable sections of ASHRAE and SMACNA HVAC systems testing, adjusting and balancing procedures.
  - The entire system shall be tested for noise, tightness of joints and proper functioning of the system. Noise tests shall be made under minimum system pressure drop conditions (highest air velocities and clean filter conditions).
  - Air volumes measured shall be within  $\pm 10\%$  of those shown on drawings unless otherwise specified for diffusers, grilles, registers where applicable and fans.
  - Ensure all temperature sensors and controls are calibrated prior to conducting test and balance procedures.
  - At the time of final inspection, recheck in the presence of the U of A/Architect, random selections of air quantities and fan data recorded in the certified report. Points or areas for recheck shall be selected by the UofA/Architect and be approximately 10% of the report data.
  - At the time of verification measure space temperature and humidity in a representative number of rooms to verify performance. Tabulate these results and bind into certified report as an appendix.
  - Testing to be conducted on a hierachial principal, i.e. each piece of equipment for proper operation, followed by each sub-system followed by entire system, followed by inter-ties to other major systems.
  - Following final acceptance of the certified reports by the Architect, permanently mark the settings of all valves, dampers, splitters and other adjustable devices so that balance set position can be restored if disturbed at any time. Do not mark such devices until after final acceptance.

- VFD controlled fan systems to be tested in bypass mode to verify satisfactory operation of static pressure high limit sensor.
  
- Piping Systems
  - Test all plumbing systems in accordance with all applicable plumbing codes.
  - Test all fire protection systems in accordance with all applicable NFPA Codes.
  - Compressed air system shall be tested to a minimum of 125% and a maximum of 150% of pressure setting of relief valve, using nitrogen, for 24 hours and pressure drop shall not exceed 10% of the minimum pressure.
  - Balance the entire water system to ensure all coils, heat exchangers, etc., are operating to design conditions. Adjust the circuits by means of the balancing valves and record balance position.
  - Each pump shall be checked for design, working and shut-off head conditions and any pump that varies by more than 10% from the design conditions shall have the impeller trimmed or changed until design conditions have been met.
  - Flow through all heat exchangers, chillers, boilers and other such equipment shall be balanced to ensure that the pressure drop through the equipment is within 10% of the manufacturer's design conditions.
  - If the design conditions cannot be met by adjusting the balancing valves throughout the system, then pump impellers shall be either changed or trimmed as required.
  - Initial balancing of coils shall be to ensure that the pressure drops are within 10% of the manufacturer's design conditions. When both the air and water systems are fully operational, entering air and water and leaving air and water readings shall be taken as close as possible to the peak design conditions to ensure the coil performance meets the design conditions. Coil water working conditions shall only be taken in conjunction with the air flow working conditions for the coil.
  - Coordinate with the Contractor to ensure that all necessary valves for control and balancing are installed in all locations required. Notify the U of A/Architect in writing that this coordination has taken place. Include in this letter any recommendations made regarding valves, locations, installation, etc.
  - Testing to be conducted on a hierachial principal, i.e. each piece of equipment for proper operation, followed by each sub-system followed by entire system, followed by inter-ties to other major systems.
  - Following final acceptance of the certified reports by the Owner/Architect, permanently mark the setting of all valves and other adjustable devices so that balance set position can be restored if disturbed at any time. Do not mark such devices until after final acceptance.
  
- **Part 2 - Products**
  - No Discussion.
  
- **Part 3 - Execution**
  - All required balancing shall be completed and the final report submitted as a condition of substantial completion.

**End of Section 15990**

## **DIVISION 16 - ELECTRICAL**

### **Section 16000 - General Discussion**

#### **Introduction**

Refer any questions, clarifications regarding Division 16 to UA Facilities Design & Construction.

The electrical system is very important to the operation of many of the aspects of the operations of the University of Arizona. Many of the buildings have testing which need to go on continuously and if the electrical power goes out during the testing then millions of dollars of work and equipment can be destroyed. For this purpose it is very important to supply the most reliable electrical equipment system that can be designed. It is for this reason that many of the systems and specifications enclosed herein exceed the requirements of the National Electrical Code. In addition it must be understood that:

The National Electrical Code is a minimum standard of the quality of work that can be used and shall not be used as a maximum for the quality of the electrical system.

The DSS is a standard each Consultant, Builder and Project Manager needs to study as a standard for ALL University of Arizona renovations and new work.

The local lighting ordinances are exceeded.

Use of metal Halide light sources shall not be permitted without written approval of the Director of Facilities Design & Construction.

The University of Arizona is itself a small utility which maintains all of the secondary power distribution to all of the buildings on its campus at both 13.8KV and 4.16KV. The standards specified herein reflect the requirements of this "utility". Note that at some other locations interface with standard utility requirements will be required. In those cases only will these standards be overruled. Attention to fault current and how it affects systems must be observed. The system energy capacity increases on an ongoing basis, as the result of ongoing campus utility modifications.

#### **ELECTRICAL SWITCHBOARD ROOMS**

Whenever the design for a new building or major expansion of an existing building is to take place special consideration shall be made for providing an electrical distribution switchboard room which is sized adequately to house all of the major electrical switchboard items which would need to be installed on the project. This shall include the primary distribution switchboard (usually 480 volt), the Fire alarm panel, some of the secondary transformers and 120/208 volt distribution panelboards, the automatic transfer switch, the generator status panel, and the motor control center (where required). This room shall have built in at least 40% spare capacity to allow for installation of future equipment as necessary and storage of pertinent electrical maintenance items. There shall be a minimum of two exits from the room with at least a 6' aisle between rows of electrical equipment or between electrical equipment and the wall. In addition a separate area shall be made to house the primary distribution transformer, the standby / emergency generator, and any primary distribution switchgear required (such as a PMH switch). This area shall be located in an equipment yard just outside of the main building walls.

#### **SERVICES**

Existing electrical services will require specific attention with respect to replacement and expansion. Projects where the existing service equipment is not to be replaced, need to be evaluated for fault current, overload, deterioration, grounding and safety violations. Where this work is designed by consultants, reports will be required at the Schematic Phase and addressed with Project Managers and the University of Arizona Electrical Engineer.

#### **SINGLE LINE DIAGRAM MINIMUM REQUIREMENTS**

Single line diagrams shall be complete representations of the designed electrical systems. The goal is to allow the bidding and constructing contractor to bid the job using the correct equipment. The reviewer will require clear indications that all electrical parameters have been considered. Bidding and review shall not require tedious deciphering of keynotes. Nor shall the reader be burdened in flipping feverishly from sheet to sheet.

Single line representations shall include, but not be limited to, display of voltage levels, wye and delta configurations, bus sizing, sizes and types of main and feeder overcurrent devices, vertical bus sizes, horizontal bus sizes, pull sections, metering sections, grounding, spare bussing, bus extension provisions, transformer sizes, main breaker or lug locations for panelboards and switchboards, (bottom, top or feed through) fault levels, overcurrent device frame sizes and trip ratings, TVSS connections, TVSS overcurrent protection, feeder sizes, transformer sizes and housekeeping pads, primary cable conductor sizes and any other information necessary to provide a complete representation of the system.

The use of keynotes shall be minimized in the labeling of equipment and system components.

*Switches, pull stations and automatic door closers in areas where the construction requires glass walls, glass doors and similar construction, shall require the architect to design mullions to accommodate orderly installation. Consultant shall coordinate these devices with the architect.*

## LIGHTNING PROTECTION

Lightning protection shall meet and exceed the requirements of NFPA 780 and the NEC.

Protection shall be provided where NFPA 780 calculation shows MODERATE conditions OR whenever directed by UA Facilities Design & Construction.

If available, UL MASTER LABELING shall be included.

Design shall be performed by the electrical registrant for the project, put on plan and sealed. It shall not be done as a requirement specification. The Consultant may feel free to seek the expertise of Lightning Protection Companies in preparing their (the Consultant's) design.

Attention shall be given to the Suppression Requirements of NEC for data, power and phone. Attention needs to be given to the material types and quality of lightning specific components and how they are fastened to the building. Mastics shall not be the primary method of attachment. Components shall be copper or bronze. Wire shall be copper. Down conductors shall be the braided UL approved copper product specifically designed for the application. Ground plates are allowed for existing buildings where grounding by other methods is not practical.

Examine the job site prior to completing your fee. Contact CCIT for suppression needs and methods. Determine such things as RF antenna on roofs, walls or parapets, "Add on" suppression for power shall be either APT OR CURRENT SYSTEMS products, not less than 180 ka per phase.

Firms having 3 dimensional capabilities shall include this graphic presentation

*Consultants shall evaluate the need for lightning protection on all new buildings and building additions. Utilize the assessment criteria in NFPA 780. Risk factors in the highly moderate to severe category shall require lightning protection.*

## COORDINATION OF PROTECTIVE DEVICES AND STUDIES

*Coordination studies, protective relay studies and adjustments shall be performed by registered electrical engineers skilled in this area of expertise.*

*The consultant shall design the system and perform key device coordination as part of his/her scope of work. This will require a basis of design "brand" in some cases. This is NOT to be an exhaustive Coordination Study. The consultant will give special attention to the sizing of busses, services transformers, motor control centers and distribution panelboards so as to assure clean system coordination. The upper device shall be the 13.8KV pad mounted switch fuse sized for less than 200 amperes. The Pad Mounted Switch (PMS) shall feed the service*



*transformer. The transformer shall have its own fusing to protect it.*

*The consultant shall submit selectivity curves in the design document and final construction documents show clean coordination of the devices aforementioned.*

*The consultant shall write the specifications to reflect the following:*

*Contractor shall submit equipment based on the basis of design or one of the approved equals. The contractor shall provide with the submittal, a coordination study based on the equipment submitted. The contractor shall be required to submit equipment equal in characteristics to the basis of design. That is to say the selectivity of the overcurrent devices shall be as clean in coordination as the basis of design devices.*

*Should the contractor submit a study, including related equipment submittal, that does not give clean coordination, the contractor shall be obligated to change components to allow clean coordination and selectivity, prior to getting approval for releasing equipment for manufacture at no cost to the Owner.*

*The contractor may utilize factory trained coordination engineers to prepare the study. However curves must be plotted on standard log-log paper, 11 in x 17 in.*

*References to clean coordination and selectivity shall be as defined in IEEE STD 192, as interpreted by the University of Arizona Electrical Engineer.*

*Coordination shall reflect all intentions of system planning per IEEE Std. 192.*

#### **TEMPORARY STANDBY POWER**

*Temporary standby power used to power existing critical (research not life safety) building loads shall require the presence of an approved generator technician for the duration of the outage.*

#### **Part 1 - General**

- These electrical standards represent the minimum quality of workmanship and the minimum quality of equipment which are required for the projects which are to be constructed on this site. The general attitude about the equipment and materials to be supplied is that this University will be here for many years to come and the projects which we construct now shall be able to be in service for 10, 15, 20, or more years without needing to be renovated due to the lack of quality of the electrical equipment or workmanship. In addition renovations will need to be made in the future to many of the areas which are under design today and for that reason spare capacity is to be built into the design to allow for a certain amount of flexibility for the future. Where the design engineer has some areas where he prefers to see an even higher level of quality than what

is set by these standards he shall make the design to meet that level of quality as long as that design provides a cost effective design. Sometimes even though the design costs are considerably higher the actual costs including maintenance over the life of the product make it cost effective.

- Working In Confined Spaces
  - Whenever work is required within a confined space, e.g., utility vaults, utility tunnels, sumps, pits, sewers, etc., contact UA Risk Management and Safety Department for details and procedures on UA Confined Space Entry Program.
- As-Builts
  - *As-Builts shall be prepared by the Contractor and professionally hand drafted in a clear legible manner. These As-Built annotations will then be drafted on the reproducible Record Drawing by the Consultant. See Tab B-9.*

#### **Part 2 - Products**

- Specify the highest quality, best made type of equipment which is manufactured today. Balance this with maintaining quality while conserving cost. If there are materials which you know from working with them in the past which you know will not meet the requirements of this area of the specifications, then word your specifications to delete those items from being considered for use. Any types of material which by their very nature need to be looked at for meeting the quality that will be specified needs to be specified to be submitted upon prior to installation for review by both the Design Engineer and the Facilities Engineer at the University of Arizona. Single sourcing of a certain type of material shall be made only when other materials would not meet either the standard of the University or the required operation of the system for which it is specified. In most cases single sourcing will not be permitted. The use of one or two manufacturers which supply equipment which is known to meet the standards which are required for the particular operation which is specified shall be utilized. Other manufacturers which may not be known at the time of design or who in the past have manufactured equipment which is not the same quality as that which is specified then will have the ability to submit their equipment in accordance with the requirements of specification section 1300.
- When specifying equipment, attention shall be given to assure that if a particular manufacturer is specified, that all related equipment is specified with regards to the same manufacturer. For instance, if GE were specified for panelboards, regards should be given that disconnects, switchboards, motor starters and transformers be GE. Single sourcing already has been officially justified for fire alarm equipment, primary pad mounted switches and variable frequency drives. Prior approval is required for engine generators, transfer switches and primary cable deviations. There is no or equal to be considered after bidding where prior approval is required.

### **Part 3 - Execution**

- It is the intent of the University to have all new work installed in a quality manner and in a way that it is accessible for future maintenance and expansion. The installation shall comply with both the requirements of OSHA, ADA Guidelines, NFPA, NESC and the NEC. In complying with OSHA regulations we wish to comply especially with the requirements of the lockout/ tagout regulations, and provide the personnel who have to work on the mechanical equipment serviced by the new electrical system with a completely maintainable system based on those regulations. As far as the quality of workmanship, we would like to have the electrical system installed in such a way that it both is functional, and looks like it has been installed in a professional manner.

**End of Section 16000**

## **DIVISION 16 - ELECTRICAL**

### **Section 16000 - General Discussion**

#### **Introduction**

Refer any questions, clarifications regarding Division 16 to UA Facilities Design & Construction.

The electrical system is very important to the operation of many of the aspects of the operations of the University of Arizona. Many of the buildings have testing which need to go on continuously and if the electrical power goes out during the testing then millions of dollars of work and equipment can be destroyed. For this purpose it is very important to supply the most reliable electrical equipment system that can be designed. It is for this reason that many of the systems and specifications enclosed herein exceed the requirements of the National Electrical Code. In addition it must be understood that:

The National Electrical Code is a minimum standard of the quality of work that can be used and shall not be used as a maximum for the quality of the electrical system.

The DSS is a standard each Consultant, Builder and Project Manager needs to study as a standard for ALL University of Arizona renovations and new work.

The local lighting ordinances are exceeded.

Use of metal Halide light sources shall not be permitted without written approval of the Director of Facilities Design & Construction.

The University of Arizona is itself a small utility which maintains all of the secondary power distribution to all of the buildings on its campus at both 13.8KV and 4.16KV. The standards specified herein reflect the requirements of this "utility". Note that at some other locations interface with standard utility requirements will be required. In those cases only will these standards be overruled. Attention to fault current and how it affects systems must be observed. The system energy capacity increases on an ongoing basis, as the result of ongoing campus utility modifications.

#### **ELECTRICAL SWITCHBOARD ROOMS**

Whenever the design for a new building or major expansion of an existing building is to take place special consideration shall be made for providing an electrical distribution switchboard room which is sized adequately to house all of the major electrical switchboard items which would need to be installed on the project. This shall include the primary distribution switchboard (usually 480 volt), the Fire alarm panel, some of the secondary transformers and 120/208 volt distribution panelboards, the automatic transfer switch, the generator status panel, and the motor control center (where required). This room shall have built in at least 40% spare capacity to allow for installation of future equipment as necessary and storage of pertinent electrical maintenance items. There shall be a minimum of two exits from the room with at least a 6' aisle between rows of electrical equipment or between electrical equipment and the wall. In addition a separate area shall be made to house the primary distribution transformer, the standby / emergency generator, and any primary distribution switchgear required (such as a PMH switch). This area shall be located in an equipment yard just outside of the main building walls.

#### **SERVICES**

Existing electrical services will require specific attention with respect to replacement and expansion. Projects where the existing service equipment is not to be replaced, need to be evaluated for fault current, overload, deterioration, grounding and safety violations. Where this work is designed by consultants, reports will be required at the Schematic Phase and addressed with Project Managers and the University of Arizona Electrical Engineer.

#### **SINGLE LINE DIAGRAM MINIMUM REQUIREMENTS**

Single line diagrams shall be complete representations of the designed electrical systems. The goal is to allow the bidding and constructing contractor to bid the job using the correct equipment. The reviewer will require clear indications that all electrical parameters have been considered. Bidding and review shall not require tedious deciphering of keynotes. Nor shall the reader be burdened in flipping feverishly from sheet to sheet.

Single line representations shall include, but not be limited to, display of voltage levels, wye and delta configurations, bus sizing, sizes and types of main and feeder overcurrent devices, vertical bus sizes, horizontal bus sizes, pull sections, metering sections, grounding, spare bussing, bus extension provisions, transformer sizes, main breaker or lug locations for panelboards and switchboards, (bottom, top or feed through) fault levels, overcurrent device frame sizes and trip ratings, TVSS connections, TVSS overcurrent protection, feeder sizes, transformer sizes and housekeeping pads, primary cable conductor sizes and any other information necessary to provide a complete representation of the system.

The use of keynotes shall be minimized in the labeling of equipment and system components.

Switches, pull stations and automatic door closers in areas where the construction requires glass walls, glass doors and similar construction, shall require the architect to design mullions to accommodate orderly installation. Consultant shall coordinate these devices with the architect.

#### LIGHTNING PROTECTION

Lightning protection shall meet and exceed the requirements of NFPA 780 and the NEC.

Protection shall be provided where NFPA 780 calculation shows MODERATE conditions OR whenever directed by UA Facilities Design & Construction.

If available, UL MASTER LABELING shall be included.

Design shall be performed by the electrical registrant for the project, put on plan and sealed. It shall not be done as a requirement specification. The Consultant may feel free to seek the expertise of Lightning Protection Companies in preparing their (the Consultant's) design.

Attention shall be given to the Suppression Requirements of NEC for data, power and phone. Attention needs to be given to the material types and quality of lightning specific components and how they are fastened to the building. Mastics shall not be the primary method of attachment. Components shall be copper or bronze. Wire shall be copper. Down conductors shall be the braided UL approved copper product specifically designed for the application. Ground plates are allowed for existing buildings where grounding by other methods is not practical.

Examine the job site prior to completing your fee. Contact CCIT for suppression needs and methods. Determine such things as RF antenna on roofs, walls or parapets, "Add on" suppression for power shall be either APT OR CURRENT SYSTEMS products, not less than 180 ka per phase.

Firms having 3 dimensional capabilities shall include this graphic presentation

Consultants shall evaluate the need for lightning protection on all new buildings and building additions. Utilize the assessment criteria in NFPA 780. Risk factors in the highly moderate to severe category shall require lightning protection.

#### COORDINATION OF PROTECTIVE DEVICES AND STUDIES

Coordination studies, protective relay studies and adjustments shall be performed by registered electrical engineers skilled in this area of expertise.

The consultant shall design the system and perform key device coordination as part of his/her scope of work. This will require a basis of design "brand" in some cases. This is NOT to be an exhaustive Coordination Study. The consultant will give special attention to the sizing of busses, services transformers, motor control centers and distribution panelboards so as to assure clean system coordination. The upper device shall be the 13.8KV pad mounted switch fuse sized for less than 200 amperes. The Pad Mounted Switch (PMS) shall feed the service

transformer. The transformer shall have its own fusing to protect it.

The consultant shall submit selectivity curves in the design document and final construction documents show clean coordination of the devices aforementioned.

The consultant shall write the specifications to reflect the following:

Contractor shall submit equipment based on the basis of design or one of the approved equals. The contractor shall provide with the submittal, a coordination study based on the equipment submitted. The contractor shall be required to submit equipment equal in characteristics to the basis of design. That is to say the selectivity of the overcurrent devices shall be as clean in coordination as the basis of design devices.

Should the contractor submit a study, including related equipment submittal, that does not give clean coordination, the contractor shall be obligated to change components to allow clean coordination and selectivity, prior to getting approval for releasing equipment for manufacture at no cost to the Owner.

The contractor may utilize factory trained coordination engineers to prepare the study. However curves must be plotted on standard log-log paper, 11 in x 17 in.

References to Clean Coordination and selectivity shall be as defined in IEEE STD 192, as interpreted by the University of Arizona Electrical Engineer.

Coordination shall reflect all intentions of system planning per IEEE Std. 192.

- Selectivity curves shall be labeled with plain English nomenclature that identifies the devices on the project single line diagram, not some dapper reference file name. Each curve set shall have a I-line on the same page.

Consultants shall provide fault current levels for all new equipment required to have ARC FAULT labeling as required in NFPA 70E.

#### TEMPORARY STANDBY POWER

Temporary standby power used to power existing critical (research not life safety) building loads shall require the presence of an approved generator technician for the duration of the outage.

#### Part 1 - General

- These electrical standards represent the minimum quality of workmanship and the minimum quality of equipment which are required for the projects which are to be constructed on this site. The general attitude about the equipment and materials to be supplied is that this University will be here for many years to come and the projects which we construct now shall be able to be in service for 10, 15, 20, or more years without needing to be renovated due to the lack of quality of the electrical equipment or workmanship. In addition renovations will need to be made in the future to many of the areas which are under design today and for that reason spare capacity is to be built into the design to allow for a certain amount of flexibility for the future. Where the design engineer has some areas where he prefers to see an even higher level of quality than what is set by these standards he shall make the design to meet that level of quality as long as that design provides a cost effective design. Sometimes even though the design costs are considerably higher the actual costs including maintenance over the life of the product make it cost effective.
- Working In Confined Spaces
  - Whenever work is required within a confined space, e.g., utility vaults, utility tunnels, sumps, pits, sewers, etc., contact UA Risk Management and Safety Department for details and procedures on UA Confined Space Entry Program.
- As-Builts

- As-Builts shall be prepared by the Contractor and professionally hand drafted in a clear legible manner. These As-Built annotations will then be drafted on the reproducible Record Drawing by the Consultant. See Tab B-9.
- Details
  - Consultant shall provide graph scales on all sheets.
- Misc.
  - When panel boards are replaced, replace respective feeders and feeder breakers
  - Designers shall coordinate motor service factors and efficiencies with mechanical trades and mechanical designers and bring this to the attention of the contractors.
  - The consultant shall make it clear to the contractor that deviations in design of major equipment shall not be a liberty that will be accepted. All equipment specified and supplied shall have been in the market place for a minimum of 2 years prior to bid date.

## **Part 2 - Products**

- Specify the highest quality, best made type of equipment which is manufactured today. Balance this with maintaining quality while conserving cost. If there are materials which you know from working with them in the past which you know will not meet the requirements of this area of the specifications, then word your specifications to delete those items from being considered for use. Any types of material which by their very nature need to be looked at for meeting the quality that will be specified, needs to be specified to be submitted upon prior to installation for review by both the Design Engineer and the Facilities Engineer at the University of Arizona. Single sourcing of a certain type of material shall be made only when other materials would not meet either the standard of the University or the required operation of the system for which it is specified. In most cases single sourcing will not be permitted. The use of one or two manufacturers which supply equipment which is known to meet the standards which are required for the particular operation which is specified shall be utilized. Other manufacturers which may not be known at the time of design or who in the past have manufactured equipment which is not the same quality as that which is specified then will have the ability to submit their equipment in accordance with the requirements of specification section 1300.
- When specifying equipment, attention shall be given to assure that if a particular manufacturer is specified, that all related equipment is specified with regards to the same manufacturer. For instance, if GE were specified for panelboards, regards should be given that disconnects, switchboards, motor starters and transformers be GE. Single sourcing already has been officially justified for fire alarm equipment, intrusion detection equipment, telephone/data hardware, primary cable, primary pad mounted switches and variable frequency drives. Prior approval is required for engine generators, transfer switches and primary cable deviations. There is no or equal to be considered after bidding where prior approval is required.

## **Part 3 - Execution**

- It is the intent of the University to have all new work installed in a quality manner and in a way that it is accessible for future maintenance and expansion. The installation shall comply with both the requirements of OSHA, ADA Guidelines, NFPA, NESC and the NEC. In complying with OSHA regulations we wish to comply especially with the requirements of the lockout/ tagout regulations, and provide the personnel who have to work on the mechanical equipment serviced by the new electrical system with a completely maintainable system based on those regulations. As far as the quality of workmanship, we would like to have the electrical system installed in such a way that it both is functional, and looks like it has been installed in a professional manner.
- Contractors shall be required to label all equipment with ARC FAULT labels as outlined and required in NFPA 70E.

## **End of Section 16000**

## DIVISION 16 - ELECTRICAL

### Section 16050 - Basic Electrical Materials and Methods

#### Introduction

The design shall be set up such that all equipment shall be provided and installed with the highest degree of quality and workmanship in both the type of equipment installed and the quality of the equipment installed.

#### Part 1 - General

- All work associated with the installation of electrical equipment at this site shall be accomplished by skilled workmen which are experienced in the type of work for which they are to accomplish. The contractor shall be licensed to do commercial or industrial electrical work. Each work crew shall consist of a maximum of 1 helper for each journeyman electrician. For all work involving the installation of medium voltage (above 600v) equipment the work shall be accomplished by a contractor having a class A-17 license. The workers on medium voltage systems shall be journeyman electricians. The definition for a journeyman electrician will be that the electrician shall have completed a minimum of 5 years in a combination of training and education of electrical equipment installation under the direction of skilled journeymen electricians.
- The plans and drawings are complimentary and anything indicated by either shall be required to be installed as if it were indicated on both.
- All work shall be installed and coordinated with all other trades. Conflicts shall be solved through a joint decision by the trades and shall be presented to the University for their approval.
- It is the responsibility of the contractor to visit the site prior to bid, and familiarize himself with any and all site conditions.
- Laboratory panels shall be accessible to users, not locked in electrical/mechanical rooms.
- Use of the metal clad cable, special restrictions:
  - Metal Clad (MC) cable will be permitted under the following circumstances:
    - In walls, for electrical outlets, stud wall construction, dry locations.
    - Following strict procedures regarding the routing. Each wall may have the MC cable running horizontally to adjacent receptacles. The run of MC cable shall not run horizontally to adjacent walls. Instead, the run shall go up in the wall to a J-box in the interstitial ceiling space.
    - Horizontal runs of circuitry in the interstitial ceiling space shall be in EMT or GRC. Home runs shall be EMT or GRC.
  - Metal Clad (MC) cable shall meet the following:
    - It shall be steel with factory installed conductor, stranded copper wire, each conductor color coded.
    - The end fittings shall be Arlington Industries, SNAP 2 IT with insulated throats. Substitutions will not be considered.
- All other wiring systems shall be as specified.
- Elevators shall have their own direct feed feeders.

## **Part 2 - Products**

- All products specified for use at this site shall be UL listed or CSA certified for the use specified herein.
- Provide submittals for all equipment as indicated in the section under which it is specified in accordance with the provisions of Division 01300.
- All equipment shall be protected from the elements between time of delivery to site and actual installation. No equipment shall be installed until it is obvious that no normal damage will occur to the equipment between the time of installation and the end of the contract. All equipment, whether installed or on site awaiting installation, remains the property of the contractor until the end of the contract.
- Conduit Sleeves / Concrete Walls & Floors Above Grade
  - Shall be schedule 40 steel
  - Sized for full dimensions of insulation and fire caulked where required
  - Install in all exterior walls, fire walls and floors
  - Floor sleeves to extend 1" above floor surface
- Conduit sleeves in non-rated, non-masonry walls or partitions. Provide 24 gage galvanized steel.
- **Part 3 - Execution**
- All work shall be accomplished in accordance with the latest NEC. A copy of the latest code book and project specifications shall be kept at the premises.
- Prior notice of any power shutdowns or any disruptions to existing facilities shall be coordinated by the contractor as directed by the Construction Project Manager.
- All work shall be inspected prior to covering and any work covered prior to inspection will be made available for inspection at the option of the Construction Project Manager. No additional fees will be provided to uncover work covered prior to inspection.

## **End of Section 16050**



## **DIVISION 16 - ELECTRICAL**

### **Section 16110 - Raceways**

#### **Introduction**

The general attitude on conduit systems is that in the future any area which does not have surface mounted raceways in the area at present shall not have them in the future. New conduit in an existing gypsum board wall shall be either fished with steelflex or EMT caps, or shall have wall notched and then patched for installation of new conduits. In addition it is the intent of this section that conduits being installed now shall provide for additions in the future.

Reducing washers are prohibited except where approved by the UA Electrical Inspector or Electrical Engineer.

The minimum size of each conduit shall be 3/4" unless noted otherwise below.

The maximum number of circuits in a new conduit is 3. Remodels may add up to 6.

For homeruns a j-box shall be located above the lights in an accessible location to allow for future expansion. No home run shall terminate in a wall mounted device box. Use a separate J-Box.

For underground utility projects the information in section 16115 shall apply.

Do not substitute conduit fittings for pull boxes.

- 1/2" conduit shall be allowed where terminating to a one gang device box from an above ceiling J-box.
- Specific housing projects will permit 1/2" emt raceways in lieu of 3/4" but homeruns shall be 3/4".
- **Part 1 - General**
- Provide a submittal for conduit, wireways, and fittings.
- Reducing washers are prohibited except where specifically approved by the electrical inspector. A ground bushing will be required wherever reducing bushings are authorized.
- Stud to stud supports are required in all metal framing, in order to support boxes.
- Scrap conduit shall not be used for conduit supports.

#### **Part 2 - Products**

- EMT
  - Use steel compression type fittings, and couplings.
  - Connectors shall have insulated throat.
  - No factory emt bends allowed below 1".
  - No Condulet type fittings over 1 1/2" unless approved by UA Electrical Inspector or Electrical Engineer.
- Galvanized rigid steel (GRC)
  - No running threads.
  - Use one piece couplings.
  - Use Ericsons only where approved by engineer.
  - Double locknuts and threaded insulated steel bushings at all boxes.
  - Minimum 3/4".
  - No Condulet type fittings over 1 1/2" unless approved by UA Electrical Inspector or Electrical Engineer.

- Steelflex
  - Minimum size  $\frac{3}{8}$ " with #14 THHN wire. (For connection to an individual light fixture or with a single circuit)
  - No pre-wired raceways.
  - 1 screw compression or set screw connectors only.
  - Maximum 6' length.
  - No Aluminum flex.
  - No BX cable.
  - No MC unless approved by UA Electrical Inspector or Electrical Engineer.
  - Use integral insulated throat fittings.
- Liquid tight flexible conduit, steel core (LTFC)
  - Equal to Sealtight.
  - Minimum size  $\frac{1}{2}$ ". (For connection to a single motor or device with less than 5#12)
  - Use insulated throat compression type steel connectors.
  - Maximum length 6', minimum length 2'.
  - All device wiring shall be field wired by the electrical contractor. Suitcase type connectors shall not be used. Submit samples for evaluation by FDC Inspector.
- PVC
  - Schedule 40 minimum wall thickness.
  - Minimum size  $\frac{3}{4}$ ".
- SURFACE MOUNTED RACEWAYS
  - Shall be as manufactured by Walkerdect or Wiremold.
  - Minimum size shall be equal to type 700 WM.
  - No PVC or plastic wiremold products will be permitted.
  - Utilize manufacturer's products for all transitions from conduit systems and for all bends, offsets, or otherwise appropriate situations. Minimize field modifications to the raceway.
- Conduit bodies allowed  $\frac{3}{4}$ " through 1  $\frac{1}{4}$ " only.

### Part 3 - Execution

- Conduit system must be complete prior to pulling cables.
- EMT
  - Use in gyp board walls, surface mounted in equipment rooms, and where not subject to moisture or damage. EMT to route vertically only in walls in areas with drop ceilings. No horizontal runs through walls unless specially approved by U of A, FDC Inspector and Electrical Engineer.
  - Condulets shall not be used indoors in place of pull boxes.
  - Route conduit not less than 1' above drop ceilings and no higher than 36" above unless approved by FDC.
- Galvanized Rigid Steel
  - Use above grade where subject to weather.
  - Use where subject to moisture.
  - Use where subject to damage.
  - Use for all bends and offsets in underground runs or in block walls.
  - Use within 5' of building walls, if penetrating the structure, in underground runs.

- Use in all light pole bases.
- All indoor runs larger than 4" except communications or special systems.
- Underground or in concrete must be half lap wrapped with 10 mil PVC tape or painted with bitumastic compound.
- Use in tunnel
- Use at a height of 4' and below in all Electrical, Equipment and Mechanical Rooms or where subject to physical damage.
  
- Schedule 40 PVC
  - Use only below grade.
  - Use only with approved PVC supports.
  - Use inside of block walls, with solid grouted cells.
  - May be used as a sleeve inside of building for grounding or lightning protection wiring.
  - All bends and offsets shall be in rigid steel (GRC) elbows.
  - All stub ups shall be GRC.
  - See Section 16115 for installation requirements (dept, encasement, etc.).
  
- Steelflex.
  - Use only where permitted by Engineer or for feed to lights or smoke detectors in a t-bar ceiling.
  - Use where required for fishing existing stud walls to a single device.
  - Provide sufficient length for loop at bottom of flex. (Do not draw tight).
  - Use for dropping conduit down an existing wall with limited ceiling height.
  
- Liquid Tight Flexible Conduit (LTFC)
  - Use only where permitted by Engineer.
  - Use for final connection to all equipment.
  - It shall not be used to penetrate sheet metal enclosures.
  - Provide sufficient length for loop at bottom of flex. (Do not draw tight).
  
- Surface mounted raceways (Wiremold or approved equal)
  - Use in renovation projects where existing walls do not allow fishing or notching of walls. All other uses shall not be permitted without the approval of the Engineer.
  - Must use Wall box connection when connecting to a flush mounted wall box.
  - Must use center dividers when used for more than one system.
  - File all cuts smooth prior to installation.
  - Use factory manufactured cutters.

Support all conduits from structure minimum of 5' centers and within 18" of a box; connector, coupling or factory 90° bend and at closer intervals where required by NEC.

Reference Section 16190 for means of support.

**End of Section 16110**

## **DIVISION 16 - ELECTRICAL**

### **Section 16115 - Underground Conduits And Distribution Duct Banks**

#### **Introduction**

When preparing the layouts for new underground distribution for the electrical systems, future capacity shall be included to provide for expansion/modification of the services in an area. In this area common sense and a discussion with the University of Arizona Electrical Engineer and the FM Electrical shop shall be used in determining how many additional conduits shall be installed in a duct run above the number needed for actual work in the project. In addition it shall be the responsibility of the engineer doing the design to consult any and all of the as built documentation of an area prior to laying out the duct bank for a particular area. Any changes caused by the lack of proper investigation shall be fully documented by the engineer in the form of revised drawings and not notes added to the original drawings. Fully document and detail the drawings such that major obstructions and other utility services are clearly indicated on the drawings.

#### **Part 1 - General**

- Provide submittals for conduit, fittings, manholes, handholes, and all associated appurtenances.

#### **Part 2 - Products**

- UNDERGROUND CONDUIT AND DUCT BANKS
  - Use GRS (galvanized rigid steel) or PVC schedule 40 for underground conduit and duct bank installations. Installation parameters are prescribed in Table 1 below.
  - Where required concrete encasement shall be either 2000 psi or 3000 psi.
  - Red colored concrete encasement, where required, shall use a red pigment integrally mixed into the concrete. Dry shake or broadcast coloring agents are not to be used.
  - Use GRS (galvanized rigid steel) for all offsets and bends. Tape all underground GRS conduit with 10 mil PVC tape, half lapped or coat with a bitumastic compound.
  - For concrete encased conduits use manufactured PVC spacers and mounts for support and spacing of the conduits. Do not use concrete blocks or other means to support and space conduits that are to receive concrete encasement.
  - A metallic backed marking tape shall be installed 12" above all underground conduits and duct banks.
- MANHOLES AND HANDHOLES
  - Minimum 12" x 18" x 12" with solid nominal I.D. concrete bottom for power or lighting runs. For High Voltage work manhole shall be sized similarly to existing manholes on campus.
  - Shall be constructed out of 3000 PSI steel reinforced concrete.
  - Shall be traffic rated construction.
  - Cover shall indicate type of wiring enclosed within.
  - Shall include a securely mounted removable ladder when over 4' deep.

#### **Part 3 - Execution**

- UNDERGROUND CONDUITS AND DUCT BANKS
  - Install underground conduits and duct banks per Table 1, below, and locate a minimum of 1' from other utility systems, including phone, steam, sewer, chilled water, etc.

Table 1

Underground Conduit and Duct Bank Installation Requirements			
	Above 600V	600 V and Below	Other Systems
Below Building Slabs	PVC or GRS, 36" deep, red concrete encasement, 3000 psi	PVC or GRS, 18" deep, no concrete encasement required	PVC or GRS, 24" deep, no concrete encasement required
Outside of Bldg.	PVC or GRS, 36" deep, red concrete encasement, 3000 psi	GRS, 36" deep, no encasement, <u>or</u> PVC, 24" deep with 2000 psi concrete encasement, plain	GRS, 36" deep, no encasement, <u>or</u> PVC, 24" deep with 2000 psi concrete encasement, plain
Outside of Bldg. Min. depth requirement cannot be met	Special permission required, Contact FDC Inspection		

- Install not less than 4- #4 reinforcing bars tied to a square cage at 8' centers for conduits in bank under roadways.
- Concrete encased with a minimum envelope of 3" around each conduit where encasement is required.
- Minimum 3" spacing between outer diameter of conduits.
- Conduits to be used for high voltage cable shall be installed by journeyman electricians having minimum of five years experience in the installation, splicing, and testing of high voltage wiring. Contractor shall have class A-17 license for minimum of 2 years prior to work.
- Use bell adapters where conduits enter manholes.
- Concrete shall be red dyed utilizing red dye mixed into the concrete for a minimum of 5 minutes prior to pouring. Minimum of 1 bag of dye per 1 yd of concrete.
- For 4" diameter and larger GRS conduit bends, minimum bending radius shall be 48". Standard factory bends may be used for 3-1/2" diameter and smaller GRS conduit bends.
- Tie banks down and stake using rebar at each support.
- Spacers and supports to be at 5' centers.
- Conduits shall be cleaned and tested for continuity prior to installation of cables as follows:
  - A steel sectional mandrel shall be pulled through the conduit. The mandrel outer diameter shall not be less than .5" less than the inside diameter of the conduit.
  - Should the mandrel become stuck in the conduit then the length of conduit where the mandrel was stuck shall be condemned and replaced to the satisfaction of the U of A Electrical Engineer.
  - The conduit shall then be swabbed out by pulling through a brush and/or rags which remove any additional debris from the conduit.
  - Spare conduits shall receive a pull strong and be capped at both ends. Spare conduit shall be identified as to other end. Spare conduit where subject to weather shall be sealed using a coupling and steel insert.
- MANHOLES AND HANDHOLES
  - Ring and lid shall be installed above grade so that water drains away from them.
  - Shall be installed on a bed of gravel (minimum of 12" deep) with a drain hole to allow for water to drain out of them.
  - Shall be installed with cover flush on sidewalks.
  - Shall be installed with top of cover minimum 2" above grade in landscaped areas.
  - For handholes use cover appropriate to the area located.

- For manholes use traffic rated cast steel outer cover with an inner lid which can be padlocked from above. The inner lid shall be welded to the manhole ring.
- Provide a  $\frac{3}{4}$ " x 10' ground rod driven into the bottom of the manhole near one of the sides for grounding of wires and cables.
- Provide pulling irons opposite potential duct entrances.
- Have inset unistrut to allow for cable racks in manholes.
- HV Cable racks shall have porcelain insulators. Loop high voltage feeders around the inside of the manhole tied to the insulators.
- Manhole covers shall be manufactured with inscriptions for "Electrical" and "Communications" and be weld-bead inscribed with U of A. This welding shall be performed by a certified MIG (GMAN) welder with the proper approved skills.
- Manhole steel rings, frames and covers shall be "NIKKO". No exceptions.

**End of Section 16115**

## **DIVISION 16 - ELECTRICAL**

### **Section 16120 - Wire and Cable**

#### **Introduction**

All wire to be in conduit UNLESS APPROVED BY UA Electrical Inspector or Electrical Engineer.

Design is to make conduit system available for use in future.

Maximum of three circuits in each conduit for all new installations. Remodels may have six.

Where more than one 20 amp circuit is installed in a conduit with a common neutral, size neutral conductor to #10.

#### **Part 1 – General**

- Wiring of different system voltages shall be in separate raceways separated gutter compartments required.
- Wiring color coding to be as indicated under Section 16195.
- Grounding and grounded conductors to be identified at all visible points.
- In order to provide for future wiring when calculating box fill maximum fill shall be 70% of code fill requirements.
- All power and lighting conduits shall contain a ground conductor sized per NEC 250-95.
- All wire shall be new.
- All wire removed from conduit shall be discarded.

#### **Part 2 - Products**

- 600 volt insulation minimum on all cables unless specified otherwise.
- All wiring to be minimum #12 AWG stranded copper conductors. Only exception is for fire alarm circuits where #14 solid copper conductors shall be used.
- All wire is to be new and brought to the job site in unopened packages.
- Use THHN/THWN for all sizes between #12 and #4 AWG. Use XHHW-2 for all sizes #2 and larger. Do not use #3.
- Control cabling for instrumentation shall be twisted shielded pair No. 18 ga. Minimum copper conductors with overall foil shield where used for 4 to 20ma or 1 to 10 volt control signals. For 120 volt control signals use minimum of No. 14 ga. Stranded copper.
- For wire sizes #6 and smaller as appropriate for the devices, wiring may be connected using wire nut type of wiring connectors. Twist wires together before applying wire nut. *Interior of nuts shall be metallic. Submit samples for approval.*
- Joints in cables #6 and larger shall be made with solderless connectors. Either compression type connectors or split bolt connectors and a combination of rubber and plastic "Scotch 33" type of tape shall be used.

- Connections at terminal strips shall be made using either compression type of terminals or a ring or spade connector must be installed on the wire before connecting to a screw terminal. Wrapping stranded wire at a screw terminal is not permitted.
- *Suitcase type connectors are disapproved.*

### **Part 3 - Execution**

- Wire shall be color coded throughout its length. Wires #8 and smaller shall be color coded using colored insulation. Wires #6 and larger shall be identified with multiple rings or spirals of color coding tape at each box or piece of equipment.
- Use fire alarm manufacturers standard color coding for fire alarm circuits.
- Conduit system shall be complete prior to pulling in wires.
- Use only UL approved wire lubricant. No grease or silicon which could damage the insulation of the cable shall be used.
- Any run of conduit which does not permit conductors to be pulled in readily shall be condemned and replaced to the satisfaction of the Engineer.
- When pulling in cables for feeders use power operated pulling equipment only where specifically approved by Engineer.
- Protect wires at all locations where exiting from conduits.
- Carefully cable all wires in panelboards, gutters, and wireways. Use tie wraps where needed.
- Do not use tape to cable wires either for pulling into conduits, or for cabling in panels, gutters, or wireways.
- Do not combine systems of various voltages or circuits from separate sources in the same conduit system.
  - Exceptions
    - Readily identifiable low voltage conductors for lighting system control may be run in the same conduit as the power conductors for a terminal drop to a light switch or to a single light fixture.
    - Motor control wires (not including control wiring for a VFD) may be installed in the same conduit as the power wiring if they can be installed without damaging the smaller wiring.

### **End of Section 16120**



## **DIVISION 16 - ELECTRICAL**

### **Section 16122- PRIMARY POWER CABLES**

#### **Introduction (Refer to Appendix For Approved Master Spec.)**

The goal at this site is to provide looped power distribution to all buildings on the main campus power system. In addition in the future we would also like to change the service to the University to eliminate all of the 4160 volt distribution and replace with 13.8 KV distribution. All new designs should reflect that plan. All cables should be capable of connecting to either 13.8 KV or 4160 volt systems. The cable should be either tied to an existing looped system with PMH switches or to a new looped distribution system as per the U of A Electrical Engineer. All cable should be shielded and run in duct banks out of the existing (or new) tunnel system.

#### **Part 1 - General**

- Incorporate attached specification as applicable into your specification.

#### **Part 2 - Products**

- Incorporate attached specification as applicable into your specification.

#### **Part 3 - Execution**

- Incorporate attached specification as applicable into your specification.

**End of Section 16122**

## **DIVISION 16 - ELECTRICAL**

### **Section 16130 - Boxes**

#### **Introduction**

Types of boxes - outlet and receptacle boxes, and metal junction and pull boxes. Underground concrete boxes or manholes are discussed in underground distribution systems.

Boxes are to be left in such a manner that they are both accessible for future access, and that spare space (per NEC ) is available for working with additional conductors.

#### **Part 1 - General**

- DEVICE BOXES
  - NEW WORK minimum size to be 4"sq. x 2 1/8" deep with adequate space for devices, wires, and 30% spare fill capacity except as approved by Owner.
  - REMODEL use flush mounted boxes in existing walls (notch GWB walls if necessary). Use 4" sq. boxes.
- JUNCTION BOXES
  - NEW WORK minimum size 4 11/16" sq x 2 1/8" with 1/2" and 3/4" knockouts on each side. For conduits 1" and larger use boxes 6 x CS (conduit size) X 8 x CS, x 4" minimum or as per NEC 370-28. Provide for 30% spare fill capacity in all junction boxes. Extension boxes are not permitted.
  - All home runs shall have a j-box located in an accessible location *above the ceilings (in interstitial ceiling spaces)*.
  - All existing junction boxes in an area remodeled shall be left accessible or relocated to an accessible location.
  - All j-boxes 4 11/16" sq. x 2 1/8" sq. or smaller shall have both 3/4" and 1/2" knockouts on all sides.
  - Ground tails shall be installed in boxes prior to rough-in.

#### **Part 2 - Products**

- DEVICE BOXES
  - Shall be galvanized steel one piece boxes. No more than one plaster ring shall be utilized with each box. Gangable boxes or handy boxes shall not be used without prior approval of the engineer.
- JUNCTION BOXES
  - Shall be galvanized steel or metal with baked enamel. Where used outdoor boxes shall be NEMA 3R rated. Where subject to corrosion shall be NEMA 4X SS.
  - For new work no extension boxes will be permitted.

#### **Part 3 - Execution**

- DEVICE BOXES
  - No Madison clips used as supports.

- Rigidly supported to structure independent of conduit system support.
- Flush mounted shall not have more than 1/8" gap.
- No back to back devices or boxes in walls unless approved. Offset all boxes *in* non-fire rated walls minimum of 6". For fire rated walls provide minimum 24" separation or use approved fire assembly.
- Where transitioning from flush mounted j-box to surface mounted raceway, horizontally mount the plaster ring so that the proper type of wall box connection may be utilized with the surface mounted raceway.
- Surface mounted boxes shall be 4" square boxes, with industrial raised device plates. These shall be only used in equipment rooms or where specifically approved by the U of A Electrical Engineer.
- Cut in boxes may be used in remodel applications where conduit is fished down existing stud walls.
- JUNCTION BOXES
  - Shall be rigidly supported to structure independent of conduit system.
  - Shall be accessible.
  - Runs between junction boxes shall not exceed 90'.
  - Shall be identified per Section 16195.
  - Shall not be located more than 3' or less than 1' above a drop ceiling.
  - Covers shall be attached with machine screws only. NO self tapping screws or wood screws shall be utilized in attaching the cover.
  - Reference 16190 for supports and anchors.
  - Shall not have concentric knockouts unless specifically approved by the U of A Electrical Inspector or FDC Engineer.
  - Use grounding bushings on all enclosures having concentric and eccentric knockouts where such knockouts are approved by the University of Arizona Inspector.
  - No powder actuated, plastic or lead fasteners. Install boxes with machine screw type fasteners.

**End of Section 16130**

## **DIVISION 16 - ELECTRICAL**

### **Section 16140 - Devices**

#### **Introduction**

The design should take into account not only what type of equipment is to be connected to the device but also what type of loading will occur on the circuit when determining the number of receptacles on each circuit.

- Designers shall provide at least one outlet on each wall unless construction with doors and walls prevent sensible construction.
- Minimum of 1 convenience circuit shall be installed in each individual office.
- Maximum of 6 receptacles on each circuit for office areas.
- Dedicated circuit for copiers.
- Dedicated circuit for laser printers.
- Dedicated circuit for microwave.
- Hallway receptacles shall be connected to circuits which are independent of the office or other room receptacles.
- Wall switches shall be on the latch side of doors according to the architectural plans. Where two level switching is used switches shall be in the same J-box. Motion sensors with override button shall only be installed in specific situations approved by UA Electrical Inspector or Electrical Engineer.

#### **Part 1 - General**

- Due to the rough treatment of devices at this facility industrial quality heavy duty specification grade devices and receptacles are used.

#### **Part 2 - Products**

- Pass & Seymour, Arrowhart, Leviton, and Hubbell are approved manufacturers. Hubbell shall be the basis of design.
  - All devices shall be heavy duty specification grade, back & side wired minimum 20 A rated devices. Included here are standard wall outlets, light switches, GFCI, and IG receptacles.
  - Receptacles shall have a one piece brass strap and grounding system.
  - Back wire through a hole with clamp type screw. Tightened assembly suitable for stranded wires.
  - Color of devices shall match the existing for main campus modifications, and ivory for AHSC and all new construction.
  - Devices used for emergency power shall be red.
  - Isolated ground devices shall be orange.
  - All wall plates shall be stainless steel, satin finish, minimum of .035" thick. Sierra Brand, to match plates specified in 16700.

- Exterior device plates shall have separate covers for each section of the device. Plate shall be constructed of either polycarbonate or cast aluminum. The unit shall be rain tight with plug in use.
- Lighted toggle switches shall be used in all electrical, mechanical, equipment rooms and in tunnels. Color shall be white or clear. Wire so that they glow when the power is off.

### **Part 3 - Execution**

- Install receptacles with the ground stab up in vertical mounting or neutral stab up in horizontal mounting.
- Install such that devices are either perpendicular or parallel to the floor or adjacent walls.
- All devices shall be pigtail connected and not used as a terminal strip or feed through connector for devices down line.
- Receptacles shall be mounted at 18" above finished floor to center.
- Lab receptacles shall mount minimum of 6" above counter top. (Except where using countertop mounted devices, manufactured for that purpose.)
- Light switches shall mount at +46" above finished floor to center.
- All receptacles shall be identified per Section 16195.
- Install wiring under back wiring clamp without use of Stak-ons or crimp terminals except at ground terminals.
- Receptacles not installed in back splashes can be installed vertical above counters.
- Provide samples for approval.

### **End of Section 16140**

## **DIVISION 16 - ELECTRICAL**

### **Section 16160 - Cabinets and Enclosures**

#### **Introduction**

Since this is typically a special item used only on specific items this section shall be as specified for the particular project and shall be worked out between the Design Engineer and the U of A Electrical Engineer.

#### **Part 1 - General**

No discussion.

#### **Part 2 - Products**

No discussion.

#### **Part 3 - Execution**

No discussion.

**End of Section 16160**

## **DIVISION 16 - ELECTRICAL**

### **Section 16170 -Motor Starters**

#### **Introduction**

All motors shall be protected by motor starters (except for fire pump systems or where motor has internal motor protection) .

Where available use 480 volt 3 phase power for all motors rated above 1/2 hp. These motors should be protected by three phase motor starters with overloads on all three phases. Where 480 volts is not available utilize 3 phase power at 208 volts.

All motors 1/2 hp and smaller shall be 120 volt.

All motors 1 hp and larger shall utilize magnetic type of motor starters. All motors controlled through the use of control systems shall utilize magnetic type motor starters.

Where five or more starters are required in the same area utilize a motor control center arrangement.

Where both a starter and a disconnecting means are required at the same location use a combination starter. When using automatic controls associated with the motor use a magnetic type starter. When no automatic type of control is needed use a manual motor starter.

Motor starters shall be supplied and installed by the electrical contractor. It shall be required for the Electrical design engineer to coordinate all of the sizes of the motors and indicate the sizes of the motors on the drawings. Where motor sizes shall change due to design changes by the mechanical contractor he shall coordinate the same with the electrical contractor at no additional cost to the University of Arizona.

#### **Part 1 - General**

- Acceptable manufacturer's shall be Allen Bradley, General Electric, *Cutler Hammer*, *Square D* or prior approved equal.

#### **Part 2 - Products**

- All motor starters shall be NEMA size starters. No IEC type starters shall be utilized.
- Manual motor starters shall be heavy duty, rated minimum of NEMA size 0, and shall have separate replaceable thermal type overload relays.
- Magnetic motor starters shall be heavy duty, rated minimum of NEMA size 0, and shall have separate replaceable thermal type overload relays, one per phase.
- Combination type motor starters shall utilize type FRN rejection Full size fuses rated minimum of 600 volts. With magnetic motor starter as per above, separate 120 volt control transformer, hand- off-auto switch, red and green pilot lights, and minimum of two sets of auxiliary contacts. If an external control source is used then an auxiliary disconnect device is to be added to the starter to disconnect this when disconnecting power for the starter.
- Enclosures shall be NEMA 1 for indoors, NEMA 3R *gasketed* or the equivalent for outdoor, and NEMA 4X SS where subject to corrosion. *The basis for outdoor design/construction is Cutler Hammer NEMA 3R/12.*

### **Part 3 - Execution**

- Motor starters shall be installed at an accessible location. All motor starters shall be identified in accordance with Section 16195.
- Clearances as specified in NEC 110-16 shall be provided.
- Maximum height shall be +72" aff.

**End of Section 16170**



## DIVISION 16 - ELECTRICAL

### Section 16175 – Elevator Power and Controls

#### Introduction

There are unique University requirements. Refer to sample specification in the Appendix Section.

#### Part 1 - General

- Consultants shall provide details on plans, clearly reflecting the requirements within. The consultant shall not specify pre-manufactured equipment for machine room shunt trip and control requirements. Specifically note on the plans that the pre-manufactured items are not acceptable.
- POWER
  - The consultant shall specify generous circuitry that accommodates circuit sizing requirements by vendors notorious for requiring over sizing. Provide notations that require the contractor to provide system upgrades when elevator equipment requires larger capacity system components in excess of that shown on the construction documents. The consultant shall explicitly state in the specifications that these upgrades shall be performed without additional cost to the University. The consultant is directed to Intentionally size feeders for worse case conditions.
  - Provide a minimum elevator machine room size of 100 square feet, exclusive of the area above the hoistway (for traction elevators), and without any odd corners, narrow passages or structural interferences.
  - Main electrical elevator feed should employ a molded case shunt trip breaker and a suitably sized enclosure. Larger enclosures for electronic type breakers are to be avoided as they take up too much room in an already cramped service space. Requirements for electrical coordination to be accomplished upstream of the main elevator feed. Engineers will feed the elevator breaker from the building's main switchboard, so as to maintain a 4 to 1 separation in current trip settings between the elevator breaker and the switchboard main breaker. This is to be done regardless of the convenience of any closer distribution points that cannot afford the 4 to 1 separation.
  - Ancillary electrical elevator equipment shall be fed from a separate, solely dedicated, elevator electrical LOAD CENTER 120/208V, 3 phase, 4 wire. This elevator load center shall only be used for elevator related equipment and devices .It will provide the required means to lockout the equipment for service. Required characteristics of elevator electrical Load center are: surface mounted, copper bus, no door, dead front, 14 inches wide, lockable (lockout) breakers and a maximum size of 12 full size breaker spaces. Additional spaces are authorized only where the number of elevator related loads increases above 12 spaces. Unused breaker spaces shall not have any spare breakers installed. Ancillary elevator equipment to be fed from this panel may be, but is not limited to, the following:
    - Shunt trip control feed
    - Machine room lights/receptacles
    - Elevator car lights
    - Elevator pit lights/GFI receptacle
    - Elevator pit sump pump
    - Machine room A/C
    - Elevator Fan (A/C)
    - Hydraulic oil cooler
- Power for the machine room load center shall be on the life safety engine generator, when available.

## **Part 2 – Products**

- **SHUNT TRIP AND RELATED CONTROLS**

- The machine shunt trip breaker shall be enclosed in a HOFFMAN ENCLOSURE having a dust tight hinged door with external disconnecting handle for the breaker. The breaker shall be electronic type with LSI features, including short time adjustment. It shall have one N.O. and one N.C. contact for future use.
- The enclosure shall be oversized to accommodate the neat field wiring and installation of controls and relays associated with the requirements of all applicable codes.
- Terminal/barrier strips shall be 20 ampere rated, bakelite, industrial grade.
- Provide load center as described in Part 1, above.
- Provide 120 Volt control system with switch, Neon Pilot and Current Limiting (CL) fuse.
- Provide a schematic diagram and parts list for mounting within the enclosure.

## **Part 3 - Execution**

Refer to drawing Fire Alarm Specification & related drawings in Appendix 16720

**End of Section 16175**

## **DIVISION 16 - ELECTRICAL**

### **Section 16190 - Supports**

#### **Introduction**

This section covers support requirements for conduits, light fixtures, and all other electrical equipment.

Supports as specified herein are more strict than those required by the NEC due to the increased accessibility to areas by U of A maintenance personnel.

#### **Part 1 - General**

- *All materials shall be corrosion resistant (supports, fasteners, misc. hardware).*
- Minimum support requirements shall be as specified in the NEC for electrical equipment. Where specified herein as more stringent the more stringent shall apply.

#### **Part 2 - Products**

- CONDUIT SUPPORTS shall be as follows:
  - Width of structural strut trapeze shall not exceed 12".
  - Where individual conduits are run on walls and where appropriate one hole straps may be used. Where more than two conduits are run in parallel or where conduits are 1 1/2" or larger, support using approved structural strut members fastened to the structure at minimum of two points. Minimum strut length is 12 inches.
  - Single conduits trapeze above ceiling use 1/4" all thread and conduit hangers up to 1 1/2". For 2" and above use strut rack and minimum of 2 - 3/8" or larger all thread rods.
  - Wire shall not be used as a method to fasten conduits above ceilings. Conduit hangers or straps as appropriate shall be used to rigidly support the conduits in each situation. 18 gauge or larger galvanized tie wire may be used to tie conduits inside of metal stud walls.
  - Conduits above drop ceilings shall be supported independent of wire supports for drop ceilings, and shall not be supported on wires. Caddy #812MB18 box and conduit supports or equal may be used.
  - *Fixture whips, however, shall be permitted to be supported by the fixtures seismic wire utilizing approved clips*
  - All fasteners shall be steel threaded inserts or steel expansion shield anchors for location used. One hole straps shall be either connected to the wall studs using appropriate screws or to the wall using expansion bolts. In hollow masonry walls steel toggle bolts may be used. Plastic or lead expansion anchors shall not be used. No powder actuated fasteners shall be used. All fasteners shall be screw in type fasteners.
  - *Sheet rock screws of any type shall not be used.*
  - Fastening methods shall be subject to approval by Owner representative.
  - One hole conduit straps shall be Mineralac Med series or equal.
- LIGHT FIXTURE SUPPORTS in drop ceilings
  - Small incandescent or down lights to have one support wire.

- 2 x 2 or 2 x 4 fluorescent to have (2) support wires and earthquake clips.
- Support wires to be not less than 12 gauge galvanized steel.
- Deflection on support wires to be not more than 30% except where approved by Owner.
- All support wire connected to structure.
- Anchors in concrete to be not less than ¼" diameter. Use only drill in type anchors.
- All other fixtures shall be rigidly supported from the structure.

### **Part 3 - Execution**

- CONDUITS
  - Support on 5' centers and within 18" of boxes connector, couplings or equipment.
  - Support from structure.
  - Use strut frame or angle iron frame when no wall system is available.
- LIGHT FIXTURES
  - Support from structure.
  - Support independent of ceiling grid.
  - Earthquake clips.
  - Support from structure to a 500% safety factor
- SAFETY SWITCHES, MOTOR STARTERS, PANELBOARDS
  - Use strut backing when more than 1 is surface mounted in an area.

**End of Section 16190**

## **DIVISION 16 - ELECTRICAL**

### **Section 16195 - Electrical Identification**

#### **Introduction**

To provide ready identification of power source for maintenance personnel.

#### **Part 1 - General**

- The following items are to be identified as to source of power:

- Receptacles
- Safety Switches
- Motor Starters
- Junction boxes
- Snap Switches on inside of plate with indelible felt-tip marker

- The following items are to be identified as to what they service.

- Safety Switches
- Motor Starters
- Panelboards
- Switchboards
- Time Clocks

- The following items are to be identified to match the identification indicated on the drawings:

- Panelboards
- Switchboards
- Transformers

- Other items which require identification will be identified in the section pertaining to them.

#### **Part 2 - Products**

- For panelboards, safety switches, motor starters, switch boards use black on white plastic engraved identification signs attached using #6 self tapping screws.
- For receptacles use acrylic labels self-adhesive by "Brother P-Touch" Equip. or approved equal.
- For wires use vinyl impregnated cloth tags.
- For color coding cables use vinyl marking tape.
- For j-boxes write in large letters on cover using an indelible magic marker. Where exposed, identification is to be on inside face of cover.
- Panelboards shall have typewritten directories indicating actual room numbers and any other pertinent information for the circuit served. (I.E. COPIER ROOM 131, EF-3, NW CORNER OF ROOF, RECEPTACLES E & W WALLS RM 242). Verify room numbers with CPM *and Space Management, prior to typing the directories. Use proper room numbers. Note new room numbers on as-built drawings.*

**Part 3 - Execution**

- Require that *the new typewritten* panel directories be *installed* after each project or remodel, updated to reflect all changes. Removed panel schedules shall be returned to the *construction project manager*.
- J-boxes for fire alarm circuits shall be painted RED and labeled using an indelible black marker "Fire Alarm".
- Identify ground wires and neutral conductors at all j-boxes, pull boxes, or wherever wires are accessible. Spiral tape continuous where accessible. Ground wires and neutral conductors size #8 and below will have colored insulation.
- COLOR CODES for new work shall be as follows:

**POWER WIRING**

PHASE	120/208 VOLTS 4160/13800 VOLTS	277/480 VOLTS
A	BLACK	BROWN
B	RED	ORANGE
C	BLUE	YELLOW
NEUTRAL	WHITE	GRAY
GROUND	GREEN	GREEN

**CLOCK AND BELL**

A	BLUE
B	BLACK
C	ORANGE
BELL HOT	RED
BELL NEUTRAL	WHITE

**FIRE ALARM WIRING**

*Refer to Section 16720 (pg. 16720-7)*

**End of Section 16195**

## **DIVISION 16 - ELECTRICAL**

### **Section 16310 - Primary Switching Station**

#### **Introduction**

The goal of the electrical department is to provide a looped power distribution system at both 4160 volts and 13.8 KV which can be upgraded in the future to 13.8 KV. Each basic loop is a 400 A loop with available capacity to be able to handle all of the load on the loop from either of two main disconnects at the main distribution system. At present the PMH switch is the point where each building is to be disconnected from the loop.

Where located as part of a new construction system the PMH switch is to be located at a point that is accessible as far as future connections and for future replacement if necessary. Where for redistribution to an existing system the switch is to be located at a point that is limited in access to the general public, and accessible for future connections.

The designer shall coordinate the medium voltage design with the University of Arizona, Electrical Engineer.

PMH switch should be mounted on a concrete pad with a minimum of 6' clearance in front of all doors, an accessible exit (when the doors are open), and minimum 3' of clearance on both sides for easy access to control switches. The concrete pad shall extend to a minimum of 3' in front of all doors. The concrete pad should contain a grounding ring composed of a 3/4" x 10' copperweld or copperclad ground rod on each corner, connected by minimum of 3/0 ground wire. This ground shall be connected to the ground pad of the PMH switch exothermically.

Specify stub-outs for all unused compartments.

Specify 24" bases under all switches.

Specify fuse sizes.

#### **Part 1 - General**

- Refer to Appendix Section 16310 and incorporate into project.

#### **Part 2 - Products**

- Refer to Appendix Section 16310 and incorporate into project.

#### **Part 3 - Execution**

- Refer to Appendix Section 16310 and incorporate into project.

#### **End of Section 16310**

Section 16310 PRIMARY SWITCH STATION

PART 1 GENERAL

1.01 Description of Work

- A. The pad-mounted gear shall be in accordance with the one-line diagram, and shall conform to the following specification. This gear shall be type PMH-9 as manufactured by S&C Corporation or approved equal in Federal Pacific.
- B. The pad-mounted gear shall consist of a single self-supporting enclosure, containing interrupter switches and power fuses with the necessary accessory components, all completely factory-assembled and operationally checked.
- C. NOTE: It is the intent of the University to use equipment rated for 13.8 KV ungrounded systems on 4160 volt at this time to allow for conversion to 13.8 KV ungrounded systems in the future.

1.02 Ratings

- A. The ratings for the integrated pad-mounted gear shall be as designated below:

KV, Nominal 14.4	
KV, Maximum Design	17.0
KV, BIL	95
Main Bus Continuous, Amperes	600
Three Pole Interrupter Switches	
Continuous, Amperes (Source/Feeder)	600/600
Live Switching, Amperes (Source/Feeder)	600/600
Two-Time Duty-Cycle Fault-Closing Capability, Amperes Rms Asymmetrical	22,400
Fuses with Integral Load Interrupter	
Maximum, Amperes	200
Live Switching, Amperes	200
Two-Timing Duty-Cycle Fault-Closing Capability, Amperes Rms Asymmetrical	13,000
Short-Circuit Ratings	
Amperes, Rms Symmetrical at Mva Three-Phase Symmetrical at Rated Nominal Voltage	12,500
	310

- B. The momentary and two time duty cycle fault closing ratings of switches and bus, interrupting ratings of fuses, and one-time duty-cycle fault-closing capabilities of the fuses with integral load interrupters shall equal or exceed the short-circuit ratings of the pad-mounted gear.

1.03 Certification of Ratings

- A. The manufacturer shall be completely and solely responsible for the performance of the basic switch and fuse components as well as the complete integrated pad-mounted gear assembly as rated.



- B. The manufacturer shall furnish with the bid certification of ratings of the basic switch and fuse components and the integrated pad-mounted gear assembly consisting of the switch and fuse components in combination with the enclosure.

**1.04 Compliance with Standard and Codes**

- A. The pad-mounted gear shall conform to or exceed the applicable requirements of the following standards and codes:
  - 1. Applicable safety and health standards promulgated pursuant to Federal Occupational Safety and Health Act of 1970 which are in effect 30 days prior to the date of quotation or bid.
  - 2. Article 710-21(e) Circuit Interrupting Devices (Load Interrupters) in the 1984 National Electrical Code, which specifies that the interrupter switches in combination with power fuses shall safely withstand the effects of closing, carrying, and interrupting all possible currents up to the assigned maximum short-circuit rating.
  - 3. All portions of ANSI, IEEE, and NEMA standards applicable to the basic switch and fuse components.

**1.05 Enclosure Design**

- A. To ensure a completely coordinated design, the pad-mounted gear assembly shall be constructed in accordance with the minimum construction specifications of the fuse and/or switch manufacturer to provide adequate electrical clearances and adequate space for fuse handling.
- B. In establishing the requirements for the enclosure design, consideration shall be given to all relevant factors such as controlled access and tamper resistance. Provide padlock and penta head fasteners, in addition to manufacturer's normal controls.

**PART II PRODUCTS AND EXECUTION****2.01 Insulators**

- A. The interrupter-switch and fuse-mounting insulators shall be of a cycloaliphatic epoxy resin system with characteristics and restrictions as follows:
  - 1. Operating experience of at least 10 years under similar conditions.
  - 2. Ablative action to ensure nontracking properties.
  - 3. Adequate leakage distance established by test per IEC Publication 507, First Edition, 1975.
  - 4. Adequate strength for short-circuit stress established by test.
  - 5. Conformance with applicable ANSI standards.
  - 6. Homogeneity of the cycloaliphatic epoxy resin throughout each insulator to provide maximum resistance to power arcs. Ablation due to high temperatures from power arcs shall continuously expose more material of the same composition and properties so that no change in mechanical or electrical characteristics takes place because of arc-induced ablation. Furthermore, any surface damage to insulators during installation or maintenance of the pad-mounted gear shall expose material of the same composition and properties so that insulators with minor surface damage need not be replaced.

**2.02 High-Voltage Bus**

- A. Bus and interconnections shall consist of copper bar.
- B. Bus and interconnections shall withstand the stresses associated with short circuits up through the maximum rating of the pad-mounted gear, including proper allowance for transient conditions.
- C. All current carrying parts shall be copper or bronze.

**2.03 Ground-Connection Pads**

- A. A ground-connection pad shall be provided in each compartment of the padmounted gear.
- B. The ground-connection pad shall be constructed of steel, 3/8" thick for use with 600 ampere main bus which shall be copper clad and welded to the enclosure, and shall have a short-circuit rating equal to that of the integrated assembly.
- C. Ground-connection pads shall be coated with a uniform coating of an oxide inhibitor and sealant prior to shipment.

**2.04 Enclosure**

- A. The pad-mounted gear enclosure shall be of unitized monocoque (not structural frame-and-bolted-sheet) construction to maximum strength, minimize weight, and inhibit internal corrosion.
- B. The basic material shall be 11-gauge hot-rolled, pickled, and oiled steel sheet.
- C. All structural joints and butt joints shall be welded, and the external seams shall be ground flush and smooth.
  - 1. The gas-shielded short-circuiting transfer welding process shall be employed to eliminate alkaline residues and to minimize distortion and spatter.
  - 2. Any welds made by other than this method shall be ground and sanded (wire brushed if internal) to remove all scale and alkaline residues formed during welding.
- D. To guard against unauthorized or inadvertent entry, enclosure construction shall not utilize any externally accessible hardware.
- E. The base shall consist of continuous 90-degree flanges, turned inward and welded at the corners, for bolting to the concrete pad. The flanges shall be formed from double-thickness folded edges for strength and rigidity, with the sheared edges folded back into the inside of the enclosure to minimize exposure to corrosive attack.
- F. The door openings shall have 90-degree flanges, facing outward, that shall provide strength and rigidity as well as deep overlapping between doors and door openings to guard against water entry.
- G. Roof edges shall be formed to create a mechanical maze with the top flanges of the enclosure which shall allow free-flow ventilation to help keep the enclosure interior dry while discouraging tampering or insertion of foreign objects.

- H. A heavy coat of insulating "no-drip" compound shall be applied to the inside surface of the roof to prevent condensation of moisture thereon.
- I. Insulating interphase and end barriers of fiberglass-reinforced polyester shall be provided for each interrupter switch and each set of power fuses where required to achieve BIL ratings. Additional insulating barriers of the same material shall separate the front compartments from the rear compartments and isolate the tie bus (where furnished).
- J. Models containing source switches rated 600 amperes continuous shall have full-length steel barriers separating adjoining compartments.
- K. Lifting tabs shall be removable. Sockets for the lifting tab bolts shall be blind-tapped. A resilient material shall be placed between the lifting tabs and the enclosure to prevent the tabs from scratching the enclosure finish. To help retard corrosion, this material shall be closed-cell neoprene to prevent moisture from being absorbed and held between the tabs and the enclosure.
- L. Interrupter switches shall be provided with dual-purpose front barriers. These barriers, in their normal hanging positions, shall guard against inadvertent contact with live parts. It shall also be possible to lift these barriers out and insert them into the open gap when the switch is open. A window panel shall be provided to allow viewing of the switch position without removing the barriers. These barriers shall meet the requirements of Section 381 .G of the National Electrical Safety Code (ANSI Standard C2).
- M. Each fuse shall be provided with a dual-purpose front barrier. These barriers, in their normal hanging positions, shall guard against inadvertent contact with live parts. It shall also be possible to lift these barriers out and insert them into the open gaps when the fuses are in the disconnect position. These barriers shall meet the requirements of Section 381.G of the National Electrical Safety Code (ANSI Standard C2).
- N. A (steel-compartmented) base spacer shall be provided to increase the elevation of live parts in the pad-mounted gear above the mounting pad by 24 inches.

#### 2.05 Doors

- A. Doors shall be constructed of 11 gauge hot-rolled, pickled, and oiled steel sheet.
- B. Door-edge flanges shall overlap with door-opening flanges and shall be formed to create a mechanical maze that shall guard against water entry and discourage tampering or insertion of foreign objects, but shall allow free-flow ventilation to help keep the enclosure interior dry.
- C. Doors shall have a minimum of three stainless steel hinges and hinge pins. The hinge pins shall be welded in place to guard against tampering.
- D. In consideration of controlled access and tamper resistance, each door (or set of double doors) shall be equipped with a positive-action three-point latching system.
- E. Each door (or set of double doors) shall be provided with a recessed stainless steel door handle. The door handle shall be padlockable and shall incorporate a hood to protect the padlock shackle from tampering. The handle shall be provided with a recessed penta head bolt for additional security.

- F. Doors providing access to solid-material expulsion-type power fuses shall have provisions to store spare refill units.
- G. Each door shall be provided with a galvanized-steel door holder located above the door opening. These holders shall be hidden from view when the door is closed, and it shall not be possible for the holders to swing inside the enclosure.
- H. Doors shall automatically self lock open.

**2.06 Ventilation System**

- A. Ventilation system shall be provided along the bottom and top at each side of the enclosure.
- B. Each vent shall have an inside baffle to protect against insertion of foreign objects, or shall be so constructed as to prevent insertion of foreign objects.

**2.07 Finish**

- A. During fabrication, the areas of structural parts which may later become inaccessible, such as folded edges and overlapping members, shall be given a phosphatizing bath and an iron-oxide zinc-chromate anti-corrosion primer to ensure that all surfaces are protected.
- B. Any welds made by other than the gas-shielded short-circuiting transfer welding process shall be ground and sanded (wire brushed if internal) to remove all scale and alkaline residues formed during welding.
- C. Full coverage at joints and blind areas shall be achieved by processing enclosures independently of components such as doors and roofs before assembly into the utilized structures.
- D. All exterior seams shall be filled and sanded smooth for neat appearance.
- E. To remove oils and dirt, and to form a chemically and anodically neutral conversion coating to improve the finish-to-metal bond, and to retard underfilm propagation of corrosion, all surfaces shall undergo a thorough pretreatment process before any protective coatings are applied.
- F. After pretreatment, protective coatings shall be applied that shall help resist corrosion and protect the steel enclosure. To establish the ability of the finishing system to resist corrosion and protect the enclosure, representative test specimens shall satisfactorily pass the following tests:
  - 1. 1000 hours of exposure to salt-spray testing per ASTM B 11 7-73 with loss of adhesion from bare metal not to extend more than 1/8" and underfilm corrosion not to extend more than 1/32" from the scribe.
  - 2. 1000 hours of humidity testing per ASTM D 2247 with the formation of no more than #6 medium blisters as evaluated per ASTM D 714-56.
  - 3. 500 hours of accelerated weather testing per ASTM G 53-77 with no more than 25% reduction of paint gloss.
  - 4. Crosshatch adhesion testing per ASTM D 3359 Method B with no loss of paint.
  - 5. 160 inch-pound impact adhesion testing per ASTM D 2794-69 with no paint chipping or cracking.

6. Certified test abstracts substantiating such capabilities shall be furnished with the bid.
- G. The finishing system shall be applied without sags or runs for a pleasing appearance.
- H. After the finishing system has been properly applied and cured, welds along the enclosure bottom flange and around the door hinges shall be coated with a wax-based anti-corrosion moisture barrier to give these areas added corrosion resistance. Weld studs within the enclosure that are not covered by nuts shall be coated with an oxide-inhibiting compound to help guard against corrosion starting on the exposed threads.
- I. After the enclosure is completely assembled and the components (switches, fuses, bus, etc.) are installed, the finish shall be inspected for scuffs and scratches. Blemishes shall be carefully touched up by hand to restore the protective integrity of the finish.
- J. The finish shall be white. *Contractor shall sand finish with #220 grit dual action Sander Prime with duPont Vari Prime #815/8165 and apply 3 wet coats of duPont catalyzed #817 acrylic enamel.*
- 2.08 Corrosion
- A. To guard against corrosion, all hardware (including door fittings, fasteners, etc.), all operating-mechanism parts, and other parts subject to abrasive action from mechanical motion shall be of either non-ferrous materials, or galvanized, or zinc-plated ferrous materials. Cadmium-plated ferrous parts shall not be used.
- 2.09 Tamper Resistance
- A. In consideration of tamper resistance, the enclosure shall withstand a prying leverage of 75 foot-pounds applied to all joints, crevices, hinges, seams and locking means. All such openings shall prevent insertion of number 10 AWG hard-drawn copper wire after the prying leverage has been applied.
- 2.10 Interrupter Switches
- A. Interrupter switches shall have a two-time duty-cycle fault-closing rating equal to or exceeding the short-circuit rating ability to close the interrupter switch twice against a three-phase fault with asymmetrical current in at least one phase equal to the rated value, with the switch remaining operable and able to carry and interrupt rated current. Tests substantiating these ratings shall be furnished with the bid.
- B. Interrupter switches shall be operated by means of an externally accessible 3/4 inch hex switch-operating hub. The switch-operating hub shall be located within a recessed pocket mounted on the side of the pad-mounted gear enclosure and shall accommodate a 3/4 inch deep-socket wrench or a 3/4 inch shallow-socket wrench with extension. The switch-operating hub pocket shall include a pad lockable access cover that shall incorporate a hood to protect the padlock shackle from tampering. Stops shall be provided on the switch operating hub to prevent over travel and thereby guard against damage to the interrupter switch quick-make, quick-break mechanism.
- C. Interrupter switches shall utilize a quick-made, quick-break mechanism installed by the switch manufacturer. The quick-make, quick-break mechanism shall be integrally mounted

on the switch frame, and shall swiftly and positively open and close the interrupter switch independent of the switch independent of the switch-operating hub speed. Switches shall be the air break type.

- D. Each interrupter switch shall be completely assembled and adjusted by the switch manufacturer on a single rigid mounting frame. The frame shall be of welded steel construction such that the frame intercepts the leakage path which parallels the open gap of the circuit when the interrupter switch is in the open position.
- E. Interrupter switch contacts shall be of silver-to-silver construction for optimum current transfer, and shall be backed up by stainless steel springs to provide constant high contact pressure.
- F. Interrupter switches shall be provided with a single blade per phase for circuit closing including fault closing, continuous current carrying, and circuit interrupting. Spring-loaded auxiliary blades shall not be permitted. Interrupter switch blade supports shall be permanently molded in place in a unified insulated shaft constructed of the same cycloaliphatic epoxy resin as the insulators.
- G. Circuit interruption shall be accomplished by use of an interrupter which is positively and inherently sequenced with the blade position. It shall not be possible for the blade and interrupter to get out of sequence. Circuit interruption shall take place completely within the interrupter, with no external arc or flame. Any exhaust shall be vented in a controlled manner through a deionizing vent.
- H. Interrupter switches shall have a readily visible open gap when in the open position to allow positive verification of correct switch position.
- I. Each interrupter switch shall be provided with a folding switch-operating handle. The switch-operating handle shall be secured to the inside of the switch-operating hub pocket by a brass chain. The folded handle shall be stored behind the closed switch-operating-hub access door.
- J. Key interlocks shall be provided between each fuse-compartment door and all switches to guard against opening fuse-compartment door(s) unless all switches are locked open.
- K. Grounding studs shall be provided at all switch terminals. Grounding studs shall also be provided on the ground pad in each interrupter switch compartment and on terminals and ground pads in any cable-termination compartment. The momentary rating of the grounding studs shall equal or exceed the short-circuit ratings of the pad-mounting gear.
- L. Mounting provisions shall be provided to accommodate one three-phase fault indicator with three single-phase sensors in each switch compartment on units with more than one switch position.

#### 2.11 Fuses

- A. Fuses shall be disconnect style, solid-material power fuses, and shall utilize refill-unit-and-holder construction. The refill unit or fuse unit shall be readily replaceable and low in cost.
  - 1. Fusible elements shall be non-aging and non-damageable so that it is unnecessary to replace unblown companion fuses on suspicion of damage following a fuse operation.

2. Fusible elements for refill units, rated 10 amperes or larger, shall be helically coiled to avoid mechanical damage due to stresses from surges.
  3. Fusible elements shall be supported in air to allow cooling after current surges to help prevent damage.
  4. Each refill unit shall have a single fusible element to eliminate the possibility of unequal current sharing in parallel current paths.
  5. Power fuses shall have melting time-current characteristics that are permanently accurate to within a total of 10% in terms of current. Time current characteristics shall be available which permit coordination with protective relays, automatic circuit reclosers, and other fuses.
  6. Power fuses shall be capable of detecting and interrupting all faults whether large, medium, or small (down to minimum melting current), under all realistic conditions of circuitry, with line-to-line or line-to-ground voltage across the power fuse, and shall be capable of handling the full range of transient recovery voltage severity associated with these faults.
  7. All arcing accompanying power fuse operation shall be contained within the fuse, and all arc products and gases evolved during fuse operation shall be vented through an exhaust control device that shall effectively control fuse exhaust.
  8. Power fuses shall be equipped with a blown-fuse indicator that shall provide visible evidence of fuse operation while installed in the fuse mounting.
  9. Fuses shall be S&C type SML-4Z units which accept type SM-4 refill units.
- B. Fuse-mounting jaw contacts shall incorporate an integral load interrupter that shall permit live switching of fuses with a hook stick.
1. The integral load interrupter housing shall be of the same cycloaliphatic epoxy resin as the insulators.
  2. The integral load interrupter shall be in the current path continuously. Auxiliary blades or linkages shall not be used.
  3. Live switching shall be accomplished by a firm, steady opening pull on the fuse pull ring with a hook stick. No separate load-interrupting tool shall be required.
  4. The integral load interrupter shall require a hard pull to unlatch the fuse to reduce the possibility of an incomplete opening operation.
  5. Internal moving contacts of the integral load interrupter shall be self-resetting after each opening operation to permit any subsequent closing operation to be performed immediately.
  6. Circuit interruption shall take place completely within the integral load interrupter with no external arc or flame.
  7. The integral load interrupter and the fuse shall be provided with separate fault-closing contacts and current-carrying contacts. The fuse hinge shall be self-guiding and, together with the fault-closing contacts, shall guide the fuse into the current-carrying contacts during closing operations. Circuit-closing inrush currents and fault currents shall be picked up by the fault-closing contacts, not by the current-carrying contacts or interrupting contacts.
  8. Integral load interrupters for power fuses shall have a one-time duty-cycle fault-closing capability equal to the interrupting rating of the fuse, and a two-time duty-cycle fault-closing capability of 1 3,000 amperes RMS asymmetrical at 14.4 KV or 25 KV. The duty-cycle fault-closing capability defines the level of available fault current into which the fuse can be closed the specified number of times (once or twice), without a quick-make mechanism and when operated vigorously through its full travel with6ut hesitation at any point, with the integral load interrupter remaining operable

and able to carry and interrupt remaining operable and able to carry and interrupt currents up to the emergency peak-load capabilities of the fuse.

- C. Fuse terminal pads shall be provided with a two-position adapter. This adapter shall accommodate a variety of cable-terminating devices.
- D. Grounding studs shall be provided at all fuse terminals. One grounding stud shall also be provided on the ground pad in each fuse compartment. The momentary rating of the grounding study shall equal or exceed the short-circuit ratings of the pad-mounted gear.
- E. A full set of fuses, plus a full set of spare fuse refills, shall be provided for each fuse position as shown on the one line diagram.

#### 2.12 Warning Signs

- A. All external doors shall be provided with permanent "Caution - High Voltage -Keep out" signs.
- B. The inside of each door shall be provided with "Danger - High Voltage -Qualified Persons Only" signs (Bilingual English, Spanish *and Japanese*).
- C. The inside each door providing access to interrupter switches shall be provided with warning signs indicating that "Switch Blades May Be Energized In Any Position".
- D. The inside of each door providing access to power fuses shall be provided with permanent warning signs indicating that "Fuses May Be Energized in Any Position".
- E. All warning signs shall be provided in both English and Spanish.

#### 2.13 Rating Nameplates and Connection Diagrams

- A. The outside of each door (or set of double doors) shall be provided with nameplates indicating the manufacturer's name, catalog number, and model number.
- B. The inside of each door (or set of double doors) shall be provided with nameplates indicating the following: voltage ratings (kv, nominal; kv, maximum design; and kv, BIL); main bus continuous rating (amperes); short-circuit ratings (amperes, RMS symmetrical and Mva three-phase symmetrical at rated nominal voltage); the type of fuse and its ratings (amperes, one-time/two-time duty-cycle fault-closing capability); and interrupter switch ratings (amperes, continuous; amperes, live switching - load splitting and load dropping; amperes, fault-closing, duty-cycle, two-time RMS symmetrical, RMS asymmetrical, and one-second symmetrical).
- C. A three-line connection diagram showing interrupter switches, fuses with integral load interrupter, and bus along with the manufacturer's model number shall be provided on the inside of the front and rear doors (or set of double doors), and on the inside of each switch-operating-hub access cover.

#### 2.14 Auxiliaries

- A. Holders, and refill units for original installation, as well as one spare fuse unit or refill unit for each fuse mounting shall be furnished.
- B. A fuse handling tool as recommended by the fuse manufacturer shall be furnished.



- C. One bolted connector per phase accommodating NO.2 solid through 500 MCM stranded copper or aluminum conductor shall be furnished for all switch and fuse positions.

**2.15 Three-Phase Fault Indicator**

- A. A three-phase fault indicator shall be provided and installed with three single phase sensors in each switch compartment on all units.
- B. Fault indicators shall be provided at switching points on distribution circuits and unfused taps. A fault indicator shall be provided for each phase. Trip setting shall be as required for the given circuit. Reset shall be automatic and initiated by normal current. Fault indicators shall be type CR (10) manufactured by RTE Corporation, Waukesha, Wisconsin, or approved equal.

**PART 3 INSTALLATION**

**3.00 Installation**

- A. The switch assembly shall be mounted securely on a concrete pad minimum of six inches in thickness, designed adequately for the weight of the switch. The pad shall extend a minimum of 3' from the front of each set of doors. The switch shall be securely anchored to the pad per the manufacturer's recommendations. A ground loop shall circle the switch and provisions for grounding the switch and landing any grounds or shields shall be provided for within the enclosure. During installation all internal shields shall be left inside of the switch and shall not be left out of the cabinet or subject to exposure to the elements. Any shield which has been damaged due to neglect or exposure to the elements shall be replaced to the satisfaction of the University of Arizona Electrical Engineer.

**End of Appendix Section 16310**

## **DIVISION 16 - ELECTRICAL**

### **Section 16320 - Transformers (high voltage)**

#### **Introduction**

The goal at this site is to remove all of the 4160 volt distribution system and replace it with a 13,800 volt distribution system. In the long run this system would be more cost effective both to maintain and operate. In the interim all new transformers which are installed on the 4160 volt system should be dual rated 13.8 KV/4160 volts except where utilized on 13.8 KV systems.

Transformers should be mounted on a raised concrete pad a minimum of 4" above the finished floor.

At each transformer a ground ring should be supplied with a 3/4" x 10' copper weld or copper clad ground rod at each corner tied together with a 3/0 copper ground conductor. This shall supply a grounding electrode for the transformer. Exothermic weld grounding electrode conductor to transformer ground pad.

#### **Part 1 - General**

- Refer to Appendix Section 16320 and incorporate into project.
- Coordinate new building design to allow for easy removal of distribution transformers from building interiors.
- Transformers shall first be considered for outdoor placement. When indoor placement is approved, provide permanent hoisting and dolly apparatus with egress pathway for easy replacement. Utilize station transformers with a primary knife switch.
- Transformers shall be loop feed with 4-way load break switch. Mount arrestors on the spare bushings. See detail 16320-D1

#### **Part 2 - Products**

- Refer to Appendix Section 16320 and incorporate into project.

#### **Part 3 - Execution**

- Refer to Appendix Section 16320 and incorporate into project.
- All 4160 Volt & 13.8 KV equipment not utilized or in use inside or outside a building and its associated wiring shall be removed all the way back to the tunnel where it originates.

SWITCH TYPE	TYPICAL DECAL STENCIL LAYOUT	VIEW OF CONTACTS FROM FRONT (HANDLE) END OF SWITCH	POSITION 1 SCHEMATIC SWITCH HANDLE AS SHIPPED AND AS SHOWN AT LEFT	POSITION 2 SCHEMATIC SWITCH HANDLE ROTATED 90° CLOCKWISE FROM POSITION 1	POSITION 3 SCHEMATIC SWITCH HANDLE ROTATED 90° CLOCKWISE FROM POSITION 2	POSITION 4 SCHEMATIC SWITCH HANDLE ROTATED 90° CLOCKWISE FROM POSITION 3
T-BLADE MAKE BEFORE BREAK	<p>LINES A &amp; B TO C</p> <p>LINE A ONLY TO C</p> <p>LINES A TO B C OPEN</p>					

**FOUR-POSITION SECTIONALIZING  
LOADBREAKSWITCH PUB 03047 FOR INCLUSION  
IN PAD MOUNTED TRANSFORMERS**

<b>UNIVERSITY OF ARIZONA</b>	
<b>MANUAL OF DESIGN SPECIFICATION STANDARDS</b>	
<b>STANDARD DETAIL:</b>	
4-WAY LOOP FEED SWITCH	
<b>DRAWN BY:</b> C.P.S.	<b>DETAIL NO.:</b>
<b>APPROVED BY:</b> B.COUSBY	16320-D1
<b>ACAD:</b> 16320-D1.DWG	

End of Section 16320

## **DIVISION 16 - ELECTRICAL**

### **Section 16390 - Primary Grounding**

#### **Introduction**

This section applies to the main building grounding electrode system. In general this applies to new building construction or major building expansions only and is not applicable to general renovation projects.

Ground system shall be considered to be separate from the lightning protection system and its associated counterpoise but must be attached to each other. (*Typically below grade*).

#### **Part 1 - General**

- On the Main campus and at AHSC the wiring in the facility becomes a separately derived system as it relates to the distribution system supplied by the power company any time we have a local 4160 volt or 13,800 volt primary transformer. The design of this system should be based on that fact. Grounding shall be per article 250 of the NEC.

#### **Part 2 - Products**

- Provide a minimum 50' size 3/0 stranded bare copper conductor in the footing to provide for a base conductor or Concrete Encased Electrode ("UFER") ground for the electrical system. At each end bond out to a 3/4" x 10' copper clad or copper weld ground rod. At each of these points provide an inspection or test point.

#### **Part 3 - Execution**

- All primary and secondary service ground connections shall be made using an exothermic welding such as Cadweld.
  - Ground shall be bonded in at least one location to any underground metal water mains or copper water mains.
  - Ground shall be bonded to building structural steel at least one location and per the NEC.
  - The building ground system shall be bonded to any ground ring for lightning protection.
  - Bond to fire protection.
  - Bond to gas.

#### **End of Section 16390**

## DIVISION 16 - ELECTRICAL

### Section 16420 - Service Entrances

#### Introduction

Service entrance type panelboards and switch gear shall be used wherever the service enters into the facility from the utility serving the facility or where connected to a transformer served from the U of A plant power distribution network.

All new buildings should utilize service entrance switchboards sized for the load indicated. All Service entrance switchboards should utilize 100% rated power breakers.

200 – 600 Ampres; electronic with LSI  
800 Ampres and up; insulated case with LSI, add G per NEC  
1600 Ampere and up; consider use of Pringle bolted pressure switches

Metering at the service entrance shall be as specified by the utility providing the service. For buildings connected to plant power distribution this shall be as specified under division 16430.

At the Main Switchboard or at the service entrance main disconnect switch the neutral conductor should be bonded to the building or facility grounding electrode system. This system shall be as specified in section 16390 Primary Grounding.

#### Part 1 - General

- Per NEC 230 for under 600 volts and per NEC 710 for over 600 volts.
- *Consultant shall choose major protective device schemes that are easy to coordinate. Consultant shall write into the specifications in **BOLD TYPE** the requirement that a completed coordination study be submitted with the switchboard submittals/service submittals if not in conformance with the basis of design.*

*Examples:*

*Do not protect 75 KVA transformers with 100 amp fuses, use 200 amp switches fused at 125 amperes.*

*Allow 4 to 1 ratios between motors, motor control centers and upstream devices.*

*Do not size transformers for demand. Downstream main devices must clear before transformer fuses.*

*Refer to IEEE Standard 141 regarding the art of planning systems.*

- *Switchboard entries shall utilize pull sections that allow main devices to be top line, bottom load.*

#### Part 2 - Products

- Products should be the same as those specified for other divisions of these specifications except that they should meet the requirements of having a means of installing a bonding jumper between the neutral bus and the ground bus. Note that the ground bus should be bonded to the enclosure.

### **Part 3 - Execution**

- The bonding jumper must be a one piece jumper with no splices.
- The service entrance switchboard must be connected to the grounding electrode system. The minimum size of the connection should be per NEC 250-66.

**End of Section 16420**

## **DIVISION 16 - ELECTRICAL**

### **Section 16425 – Motor Control Centers, Controllers and Contactors**

#### **Introduction**

##### **Part 1 - General**

- Refer to Appendix Section 16425 and incorporate into project.
- Provide a comprehensive specification.
- Include the following in performing the design and specification:
  - Minimum vertical bussing shall be 600 amperes.
  - Centers shall be 3 phase 4 wire.
  - Center shall have main disconnecting devices.

##### **Part 2 - Products**

- Refer to Appendix Section 16425 and incorporate into project.
- Subject to submittal approval, products known to meet the University's requirements are Cutler Hammer, G.E., Siemens and Allen Bradley.

##### **Part 3 - Execution**

- Refer to Appendix Section 16425 and incorporate into project.

#### **End of Section 16425**

## **DIVISION 16 - ELECTRICAL**

### **Section 16430 - Metering**

#### **Introduction**

Metering shall be provided at the location where each building receives its service. In general the metering shall be located at the main switchboard for the building.

Metering shall consist of a separate meter for each building with local plain language annunciation at the switchboard.

Metering shall be through the use of potential transformers and 3 current transformers located in the main switch board at the building.

Metering shall have the capability of being tied into a separate system where all meters can be monitored from a separate remote control system.

For all new buildings the meters shall be tied into the existing Building Control System.

#### **Part 1 - General**

- Metering system shall have the capability of reading KWH, KVA, KVARs, Volts, Current, THD Voltage, THD Current frequency and power factor in the same system with the capability of transmitting that data to a central system where that data can be read at a central control station.

#### **Part 2 - Products**

- Provide a 1" conduit between the meter and MDF.
- New Switchboard Construction
  - New boards shall be equipped with cold sequence metering. Metering section shall utilize factory installed CT's, PT's and meter. Meter shall be equal to Cutler Hammer IQ DP6000. Additionally, the board will be fitted with cold sequence CT's, contractor purchased from VERIS INDUSTRIES, switchboard manufacturer installed. The factory metering compartment shall be factory fitted by contractor purchased VERIS INDUSTRIES Hawkeye 8163 Meter and H 8163-CB Communication Board. Contractor shall provide rigid/emt raceway from metering compartment to the building MDF telephone terminal board. Provide com cable between switchboard meter section and TTB. Provide new RS 485 jack at TTB. Meter compartment shall be dead-front with lugged swing out panel cover. Interior shall have mounting board in place.

New and existing building services without switchboards shall be equipped with the VERIS system described for switchboard systems. Where existing space will allow, provide a CT com. On new construction provide a CT com.

#### **Part 3 - Execution**

- Metering shall be located in the main switchboard, at an elevation of somewhere between 5' and 6' above finished grade, and in a readily accessible location.
- All programming for setup of meters shall be supplied and accomplished as a part of the contract.
- An identification tag shall indicate any and all multipliers at each meter. Tag shall be an engraved tag with minimum of 1/4" high letters and secured to switchboard using either screws or rivets.
- Incorporate the following diagram, 16430-D1, into the project drawings.



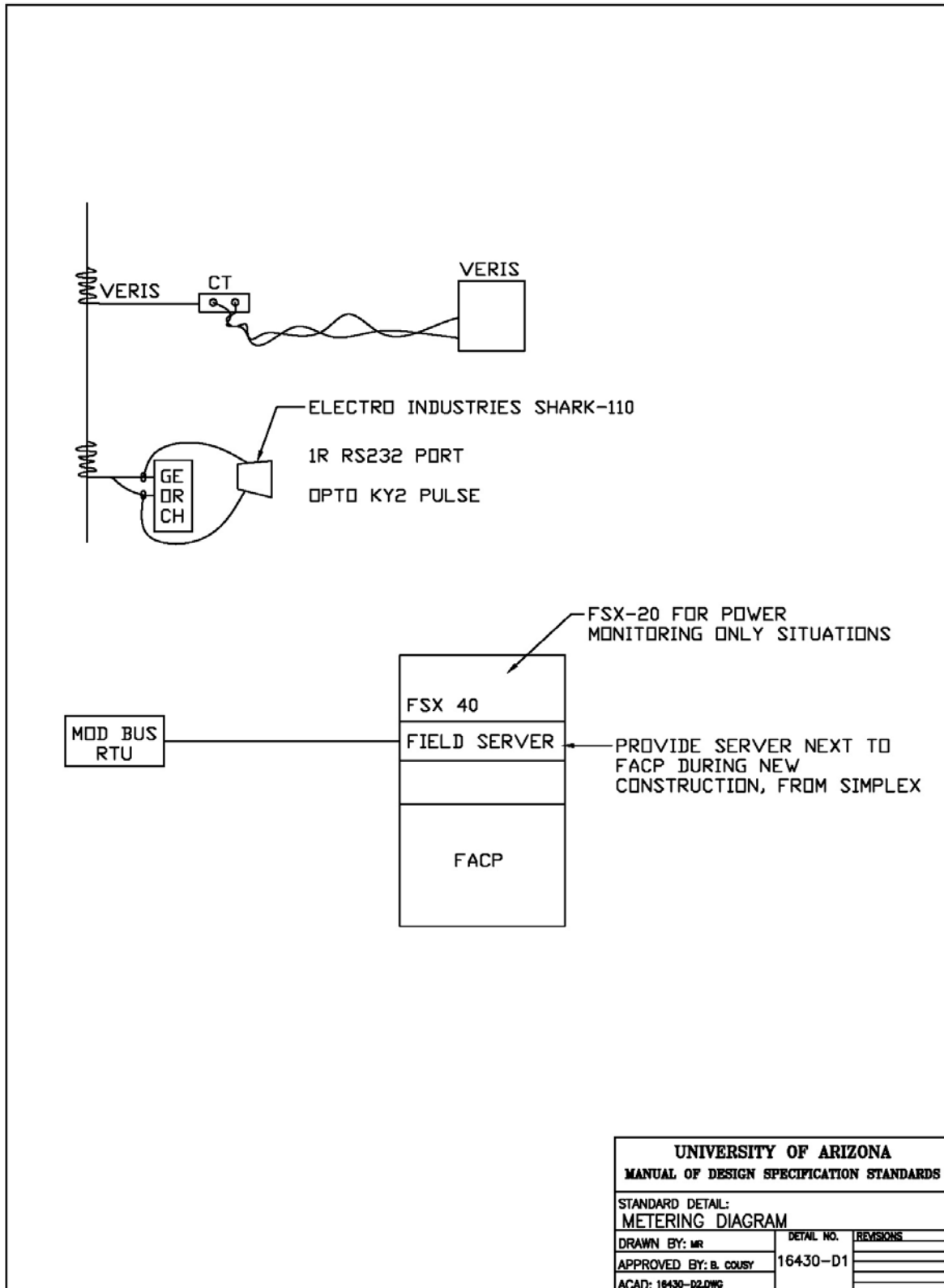

End of Section 16430

## **DIVISION 16 - ELECTRICAL**

### **Section 16435 – Switchboards**

#### **Introduction**

There are no unique University requirements.

#### **Part 1 - General**

- Refer to Appendix Section 16435 and incorporate into project.
  - Provide a comprehensive specification.
  - Include the following in performing the design and specifications.
    - Pull sections shall be required.
    - Top of main device shall be line side.
    - Sections shall have steel barriers or galactic barriers between each section.
    - Metering shall be cold sequence.
    - Metering shall be Veris as specified in the Metering Section of the Design Specification Standards.
    - Suppressor shall be hard bussed and mounted in it's own cubicle.
    - Areas next to last section shall be planned and marked on the floor for future extension. Provide the housekeeping pad now.
    - Integrated switchboard design is discouraged unless required by the University of Arizona, Facilities Design & Construction, Electrical Engineer.
    - Bussing and system design will address coordination of devices. Designer shall provide 4 to 1 separation on motor feeder devices and transformer feeder devices, when referenced to the upstream device.
    - Transformer feeder breakers shall be electronic, and coordinated to the transformer and its inrush.
    - Consultant shall base initial coordination on Cutler Hammer, General Electric or Square D.
    - Provide electronic type breakers on devices below 200 amperes whenever clean coordination cannot be achieved, including elevator feeder breakers.

#### **Part 2 - Products**

- Refer to Appendix Section 16435 and incorporate into project.
- Approved manufacturers, subject to submittal review are Cutler Hammer, GE and Square D.

#### **Part 3 - Execution**

- Refer to Appendix Section 16435 and incorporate into project.
- Edit carefully, as required for the project.

#### **End of Section 16435**

## **DIVISION 16 - ELECTRICAL**

### **Section 16440 - Disconnect Switches**

#### **Introduction**

Disconnect switches shall be used where required to meet OSHA standards for a disconnecting means within line of sight and no more than fifty feet of the actual piece of equipment being controlled.

All disconnect switches shall be heavy duty motor rated switches.

All disconnect switches required for compliance with OSHA shall be lockable.

A disconnect switch is not to be used as a substitute for a motor starter but should be used in conjunction with all motor starters where required as a disconnecting means.

#### **Part 1 - General**

- Acceptable manufacturer's should include GE, Square D, Cutler Hammer, Allen Bradley and approved equal.

#### **Part 2 - Products**

- Safety switches shall be heavy duty motor rated with fuses provided to protect downline equipment where required.
- NEMA 3R Environments shall be specified as NEMA 3R/12 gasketed.

#### **Part 3 - Execution**

- The maximum mounting height for safety switches should be 6'0" to the top. Safety switches should be rigidly mounted in place.
- Must be *readily* accessible per NEC
- Label per Section 16195

#### **End of Section 16440**

## DIVISION 16 - ELECTRICAL

### Section 16450 - Secondary Grounding

#### Introduction

This section shall cover all grounding from the secondary of the main supply transformer OR service entrance main disconnect and all wiring downstream of that point. All systems where the possibility of shock exists due to the lack of grounding shall be grounded.

**ALL CONDUITS CONTAINING WIRING TO BE ENERGIZED AT OVER 90 VAC SHALL CONTAIN A SEPARATE GROUNDING CONDUCTOR SIZED PER NEC.**

#### Part 1 - General

- As a minimum per NEC 250.
- Use grounding bond bushings for all *feeder* conduits at panelboards, switchboards, wireways, bus ducts, transformers, generators, transfer switches and any other distribution equipment.
- At panelboards only line conduits shall be required to be bonded. Load conduits for subfeed panels will also need to be bonded at each panel.
- *Wherever grounding requirements are stated in specifications, consultant shall insert requirement that contractor shall submit variance requests in writing and receive approval prior to proceeding with the variance.*
- *Refer to Drawing 16450-D1 on page 3 of this Section.*

#### Part 2 - Products

- All grounding conductors shall be stranded *insulated* copper wire *except factory tails*.
- Minimum size ground conductor to be #12. Size to be as per NEC.
- All busducts shall contain a separate copper ground bus. This shall be bonded to the enclosure.
- *Receptacle or switch bonding jumpers may be factory crimped stranded assemblies or field assembled with #12 insulated solid conductor.*

#### Part 3 - Execution

- All grounding conductors shall be color coded green. This must be visible at all visible locations such as in panelboards, cabinets, enclosures, boxes, wireways, etc.
- Isolated grounding conductors shall be green with an orange *or yellow* tracer.
- All light fixtures shall be grounded via a ground screw in the body of the fixture. The ground screw shall not be attached to a removable entrance fitting.
- All enclosures shall be grounded.
- All j-boxes shall be grounded.
- All panelboards shall contain separate isolated neutral and ground busses. An additional isolated ground bus shall be provided where required.
- All enclosures shall be connected to the grounding conductor.

- All conduit systems shall be connected to the grounding conductor.
- Bond transformer neutral to ground at the secondary of the transformer. Do not bond at any other location. An additional ground from the building ground system shall be supplied with the size as per NEC.

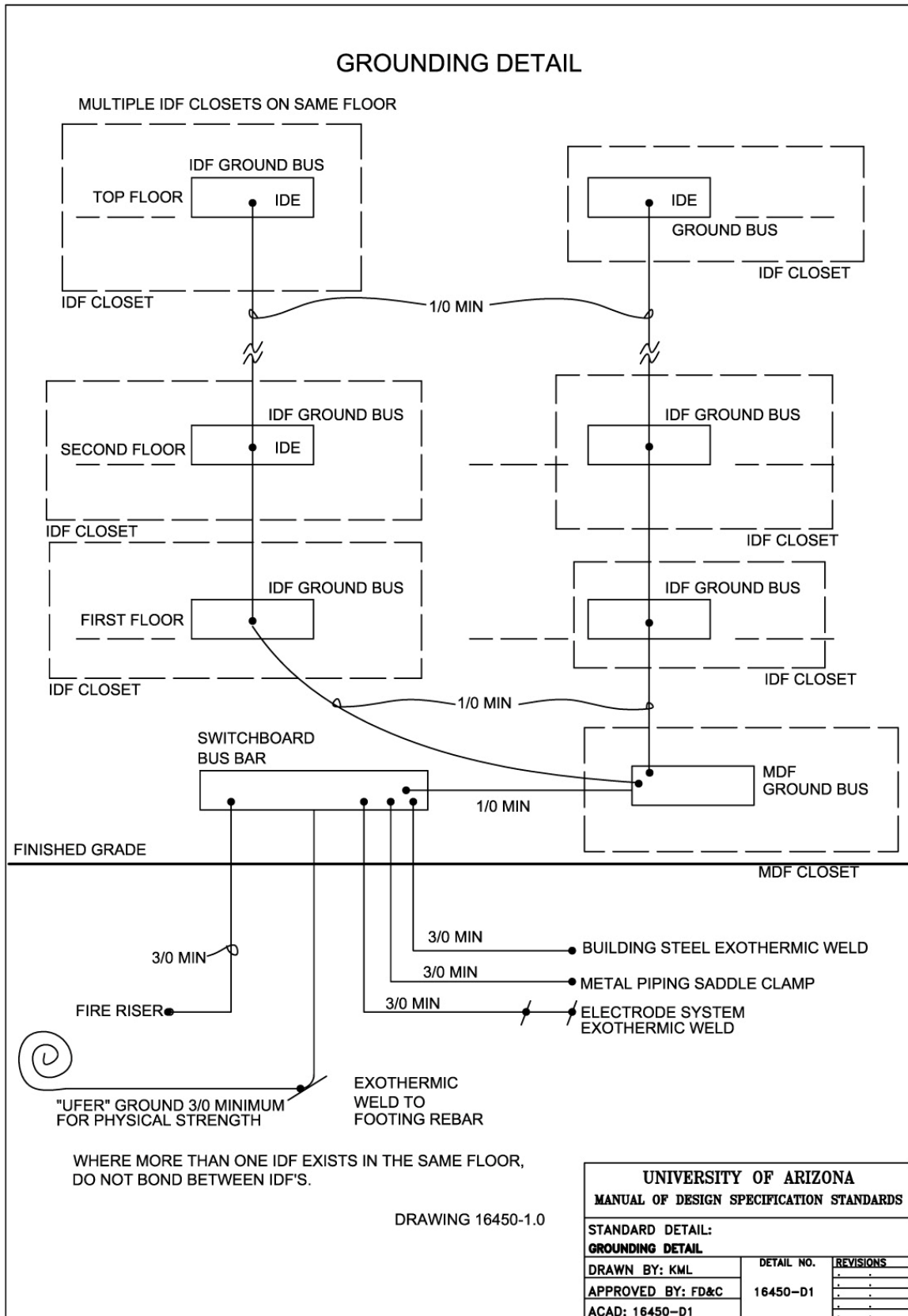

End of Section 16450

## **DIVISION 16 - ELECTRICAL**

### **Section 16460 - Transformers (low voltage)**

#### **Introduction**

This section covers transformers with primary voltages to 480 volts and secondary voltages to 120/208.

Locate transformers in an area where they are accessible for inspection on a periodic basis. All transformers are to have both secondary and primary circuit protection.

Final connection to transformers shall be in sealtight or steelflex. Minimum length shall be 3'. Conduit shall be left with an ample vibration loop.

Transformer 30 KVA and larger are to be mounted on ground level with a 4" concrete housekeeping pad.

#### **Part 1 - General**

- Transformers are to be as manufactured by PowerSmith, or approved equal.
- Contact FDC for current listing of approved transformers.
- All approved units shall have been in normal production for a period of two years prior to bid date.

#### **Part 2 - Products**

- All windings shall be copper.
- Provide 4 - 2 ½ % taps on each transformer 10 KVA and above. Two above rated voltage and two below rated voltage.
- Transformers shall be harmonic mitigating type. 3<sup>rd</sup> harmonic removal shall be considered in design. UA will consider other types of equipment to accomplish 3<sup>rd</sup> harmonic removal.
- 80°C rise transformers.
- Noise levels shall be 3 db below NEMA Standards, using the lower level NEMA parameter.
- Products shall be energy conserving type TP-1, or better.

#### **Part 3 - Execution**

- Ground transformer neutral to building steel or approved grounding electrode system where building steel is not available.
- Bond frame of transformer.
- When transformers are wall mounted they are to be mounted using factory constructed support assemblies or prior approved supports.

#### **End of Section 16460**

## **DIVISION 16 - ELECTRICAL**

### **Section 16465 - Busduct**

#### **Introduction**

Busduct should be used where it can effectively replace wire and cable at a competitive rate, or where it is needed to give an area a flexible distribution system.

#### **Part 1 - General**

- Acceptable manufacturers are GE, Cutler Hammer, or approved equal.

#### **Part 2 - Products**

- All busducts shall be copper bus with a steel, nonventilated enclosure.
- Shall include full size neutral.
- Shall include a half size copper ground. The duct case shall not be the system ground bus.

#### **Part 3 - Execution**

- Support on 5' centers and within 18" of any change in direction, to building structure.
- Support at Tap box or terminal box connection.

#### **End of Section 16465**



## **DIVISION 16 – ELECTRICAL**

### **Section 16470 - Panelboards**

#### **Introduction**

Typically we would like to see panelboards installed here in a manner that they are expandable for future requirements. For this reason no panel (as a part of the original design) should have more than 60% of the panel filled.

Panelboards shall be readily accessible where located for use by the maintenance personnel.

Wherever possible we would like to see them isolated from view of the general population in localized electrical closets so that unauthorized persons can not operate the breakers.

The general size and construction of the panelboard should be per the required load of the area plus at least 30% spare capacity (calculated).

Minimum AIC ratings for the panel should be 10,000 AIC for 120/208 volt panels, and 14,000 AIC for 277/480 panelboards.

No Load centers.

Must be readily accessible.

Do not install in doorways.

All circuits from multi pole breakers shall terminate in a single device or piece of equipment. Do not tie more than one receptacle from a multi pole breaker.

Main Breakers shall be fully electronic LSI type. Equal to Cutler Hammer digitrip OPTIMA.

#### **Part 1- General**

- Submittals will be required on all panelboards. Suggested manufacturers are GE, Cutler Hammer, Siemens or approved equal.

#### **Part 2 - Products**

- All busses shall be full capacity copper.
- Full capacity neutral bus.
- Computer rooms or areas with intensive (200% rated) electronic equipment shall use oversized neutral bus.
- Ground bus isolated from ground.
- Door in door piano hinged front panel.
- Factory installed main breaker with bolted connections to the enclosed bus bars.
- Main circuit breaker required where source is not within line of sight.
- 20" wide minimum cabinets.
- Cans shall be galvanized steel with blank end walls. Knockouts to be field punched.

- 120/208 volt panels shall have plug in circuit breakers.
  - 100 A panels should be 30 circuit.
  - 150 to 225 A panels or larger should be minimum of 42 circuit.
  - Panel sizes shall be based on full size breakers.
  - Back fed mains are unacceptable.
- 277/480 panels and distribution panelboards, 400 ampere and larger shall have bolt on type circuit breakers.
- Use plated bus in NEMA 3R applications.
- Multi pole breakers shall be manufactured for that purpose and shall not be single pole breakers tied together.
- All main and secondary breakers shall be 100% rated.
- Series rated equipment shall not be used unless approved by UA Electrical Engineer.
- Distribution panelboards shall utilize fully electronic circuit breakers, LSI for sizes 100 amperes and larger.

### **Part 3 - Execution**

- Support to 500% safety factor.
- For panels mounted flush in walls provide 1 spare 1" conduit per each 3 spare circuits or spaces. Route spare conduits to above lights or to an accessible location.
- Provide Plastic Laminate Label per Section 16195.
- Mount flush wherever possible if not in electric room or equipment room. When installing in an existing building either cut into existing wall and properly support or fir out the wall.
- Maximum mounting height 6'7" to highest breaker (center line).

### **End of Section 16470**

## **DIVISION 16 - ELECTRICAL**

### **Section 16475 - Overcurrent Protective Devices**

#### **Introduction**

The general philosophy regarding the application of protective devices is that the circuit breaker or fuse at the source must be sized to protective the wiring. The motor protective device (overloads on a motor starter) should be sized to protect the motor (except where permitted under other sections of the NEC). Where a combination motor starter is used, it is preferred that a fused disconnect be utilized rather than motor circuit protectors. (Both for single units and motor control centers).

Wiring should be always sized to be adequate to serve the load served. The maximum rating of the protective device upstream of the wiring should never be higher than the 75 °C column of Table 310-16 of the NEC or as appropriate for the actual equipment being utilized.

The AIC rating of the protective device must be adequate for the available short circuit of the devices being used. Therefore it is imperative that with each design where the primary distribution to a building is being modified that a proper short circuit calculation be made and applied to the design. Where the short circuit rating of downstream devices is not adequate for the available short circuit current then either the downstream devices must be replaced with higher AIC rated devices or current limiting devices must be used.

The load analysis for the building should be calculated each time a modification to the building loading is done so that a general building overload or a feeder circuit overload will not occur due to inattention to this detail. Should the new loads introduce a situation which would cause either a building or a feeder overload then the Engineer should discuss the situation with the U of A Project Manager and the U of A Electrical Engineer.

On new facilities all circuit breakers from the main to the 120/208 volt panelboards shall be coordinated and a copy of the coordination study provided to the U of A engineer during the construction of the facility.

#### **Part 1 - General**

- Circuit breakers should be of the same manufacturer as that of the panelboard or switchboard in which it is manufactured.
- For new equipment circuit breakers shall be either GE, Cutler Hammer, Siemens, or prior approved equal.
- Fuses shall be as manufactured by BUSS, Littlefuse, or prior approved equal.

#### **Part 2 - Products**

- Circuit breakers should be appropriate for the equipment in which they are being installed.
- 10,000 AIC minimum for 120/208 volt systems.
- 14,000 AIC minimum for all 277/480 volt systems.
- The actual ratings should be as per the short circuit analysis for the appropriate building.
- Circuit breakers for new 120/208 volt panelboards shall be plug in type.
- Circuit breakers for new 277/480 volt panelboards shall be bolt on type.
- Fuses shall be dual element time delay type fuses.
- Minimum AIC rating for fuses to be 200,000 AIC.

- Panelboard main breakers, panelboard branch breakers 100 amperes and larger, distribution panelboard breakers, and switchboard breakers shall be fully electric type. These breakers shall have at least 5 levels of adjustment, equal to Cutter Hammer “Digitrip OPTIM”. Where 5 levels are not sufficient for CLEAN coordination, the 10 levels of adjustability of the Digitrip OPTIM – 1050 is required. Enhanced thermal magnetic breakers are not to be used and will not be considered. This paragraph shall be included in all specifications prepared by engineering consultants. This information shall also be passed on to bidders in situations where contractors, such as CM at risk contractors, are formulating budgets during the early stages of project development.
- All switchboards shall have electronic interlocks for selective tripping.
- All fuses for new equipment shall be rejection type fuses with approved rejection pins at all disconnects.

### **Part 3 - Execution**

- Where multiple breakers are indicated on the drawings they shall be provided with a common trip and not as separate breakers “strapped” or “tied” together.
- Fuses shall be installed in such a manner that the fuse rating can be read from the front of the panel or switch without having to remove or rotate the fuse.

**End of Section 16475**

## **DIVISION 16 - ELECTRICAL**

### **Section 16485 - Lighting Controls and Contactors**

#### **Introduction**

Lighting contactors are to be generally used for *the* control of outdoor lighting or special effect lighting. Lighting contactors should generally be controlled via a combination of an *auto rewind* time clock and a photocell. *This is* for areas which require lighting up to a certain time and after the building is no longer in use and do not need to be on. For lighting in areas *requiring all night illumination control shall be a photocell on and off.*

#### **Part 1 - General**

- Provide submittals for contactors and associated time clocks and photocells.

#### **Part 2 - Products**

- *Photocells are the preferred control and should be adequate for the loading required where used for only one or two fixtures. Where used for more than two fixtures tie control through a contactor.*
- *Photocells shall have override switch.*
- *Time clocks shall be electronic astronomical programmable units with capacitor back up. Clock shall not need to be reprogrammed in case of a power outage. Time clocks shall have adjustable longitude and override switch.*
- Use NEMA size contactors rated for the size and type of loads required. Contactors shall be electrically held. Approved manufacturers are GE, Allen Bradley, Cutler Hammer, Square D, or prior approved equal.

#### **Part 3 - Execution**

- Locate time clocks and contactors in accessible locations in the appropriate electric room where the equipment served is located.
- Photocells should be located such that the light from the controlled lights will not cause the photocell to operate. Photocells should be located at a readily accessible location.

#### **End of Section 16485**

## **DIVISION 16 - ELECTRICAL**

### **Section 16510 - Lighting Design**

#### **Introduction**

Lighting utilizes approximately 40% of the electrical energy consumed here at the university. In order to conserve the energy it is very important that the lighting design be energy efficient.

Consideration for maintenance of the light fixtures needs to be taken into account also. If a lamp is known to have a short life or a fixture manufacturer is known for having problems with his equipment make sure to eliminate them from consideration as a manufacturer. Use linear type fixtures whenever possible. Recessed compacts are to be minimized.)

Light levels should be appropriate for the task and per the following guide in Part 1 - General.

#### **Design Guidelines**

- Lighting design shall comply with current IESNA guidelines and application notes, with selection of the median illuminance as the target optimum, not the minimum. In all areas designated higher than IESNA category C, specified illuminance shall be on task, with ambient illuminance generally task/3. In all areas, lighting targets shall be achieved by the most current energy efficient technology which meets the requirements of this Section 16510.
- Incorporation of natural daylight, and daylight-supplementing artificial light.
- Area lighting by high-CRI linear tube fluorescent with specular reflectorized interior luminaire. For applications which do not involve frequent switching, use fully electronic instant start parallel-circuit ballasts.
- Task lighting by 13 watt lamps (or smaller), with laterally offset placement so as not to cause direct or veiling glare.
- Conference room dimming: provide continuous architectural-dimming (to 10%) with linear fluorescent luminaries in place of incandescent can downlights.
- Reflectorized technologies for interior luminaries.
- Areas with visible daylight may use continuous-dimming photocell-controlled variable light output devices except those controlled by non-defeatable occupancy sensors. Daylighting contribution to be considered in calculation of IESNA target illuminance.
- Whenever possible fluorescent lamps shall meet the Federal TCLP mercury limit of 0.05mg./L

Prohibited technologies include:

- Tungsten filament incandescent except quartz-halogen
- T12 fluorescent
- VHO and SHO lamps
- Mercury vapor lamps
- U-shaped lamps (except for CFLs)
- Small-cell paracube grates and large cell paracube fixtures where the lamp is not centered into the cell
- Magnetic fluorescent ballasts
- Series-circuit ballasts
- Indirect lighting in restrooms, corridors, and utility areas
- Neon systems of any type

Occupancy Sensors shall be specified and installed in accordance with EPA Green Lights guidelines, with control technology appropriate to the application. Areas with video display terminals shall be primarily illuminated by task lighting, use of overhead luminaries in each space to be evaluated for Visual Comfort Probability. Visual acuity factors are to be treated as minus weighting factors.

#### **Discouraged Practices**

- Indirect cone and soffit lighting
- Fixtures inaccessible from a landing.

Two level Lighting control should be provided in areas where multi use of the area would require various levels of light control. Where a greater variation on the lighting is required then the use of linear fluorescent fixtures with electronic dimming ballasts is preferable as far as energy consideration than the use of incandescent fixtures with dimmers. Motion sensors with override button shall only be installed in specific situations approved by UA Electrical Inspector or Electrical Engineer.

Minimize the use of incandescent and quartz halogen type light sources since they are both expensive to operate (in both energy and heat gain) and maintain. Prior approval from the U of A electrical engineer must be obtained prior to design using either of these light sources.

Where remodeling is being done in an area it shall be considered to be part of the scope of work to bring the existing lighting in the area into compliance with this section.

Indirect type lighting sources may be used but only when it is used for special area lighting such as special conference areas, and in computer type labs.

In both new lighting and remodeling type lighting projects it shall be required to perform lighting calculations for the proposed systems and to submit point to point, area and lighting density calculations. Provide cut sheets for the fixtures proposed as a part of the schematic design of the project.

For new classroom or classroom remodel projects the fixtures shall be 2 lamp parabolic with electronic ballasts, and high reflectivity mirrored internal reflector 18 cell reflectors minimum 3" deep. One lamp is to be controlled via dimmable ballast and a second lamp by a standard electronic ballast. Ballast to allow for dimming down to 10% of rated wattage. Where wiring is required to go into podiums for light control utilize low voltage relay control such as that manufactured by GE or Douglas.

Use T5 Systems in lieu of HID in interior applications for high ceilings et.al.

## **Part 1 – General**

- Contractor to provide submittals of all light fixtures, with actual ballast type when applicable, and lamp types utilized.
- **Lighting Levels**

The following information shall be used by the designer in developing a lighting system for each specific project based on IES recommended practices, codes and ordinances, life safety requirements and good engineering practices. Major deviations due to engineering decisions shall be documented in writing and discussed with the Project Manager and University Electrical Engineer during the design development stage or schematic design stage. When in doubt, call for a presentation by the University.

- **University Lighting Standards**

Lighting levels at desk or tables tops shall be:

Hallways: 25 foot-candles average maintained foot-candles  
Public areas: 30 foot-candles average maintained foot-candles.  
Offices: 50 foot-candles average maintained foot-candles.  
Reading rooms: 50 foot-candles average maintained foot-candles.  
Classrooms: 50 foot-candles average maintained foot-candles.  
Laboratories: 70 foot-candles average maintained foot-candles.  
Machine Shops/Workshop: 100 foot-candles average maintained foot-candles.

Minimum lighting standards shall be defined as average maintained foot-candles (within the range of -10% to +25%) over the life of the lamps, unless otherwise pre-approved by the University of Arizona.

• **Preferred Lighting Densities**

The maximum lighting power density (LPD) for any building may be calculated by either the Complete Building Method (Table 2.1) or the Area Category Method (Table 2.2)

**Table 2.1  
Complete Building Method**

Building Type	Max. Lighting Power Density (W/sf)	
	Goals	Max *
General Commercial or Industrial Work Buildings	0.8	
Grocery Stores	1.2	
Industrial or Commercial Storage Buildings	0.5	
Medical Buildings and Clinics	1.0	A.R.
Office Buildings	1.0	1.8
Religious Worship, Auditorium/Convention Centers	1.3	A.R.
Restaurants	1.0	
Retail and Wholesale Stores	1.3	A.R.
Schools	1.2	
Theaters	1.0	
All Others	0.5	

\*AR means "as required"

**Table 2.2  
Area Category Method**

Area Type	Max. Lighting Power Density (W/sf)	
	Goals	Max *
Auditorium	1.3	A.R.
Bank and ATM's	1.2	1.8
Classrooms	1.3	1.8
Convention/Conference/Meeting Centers	1.0	2.0
Corridors, Restrooms, Support Areas	0.5	
Dining	0.8	
Exhibit	1.5	2.0
General Commercial and Industrial Work	0.8	A.R.
Grocery	1.3	A.R.
Hotel Function	1.5	
Industrial and Commercial Storage	0.4	1.8
Kitchen	1.5	
Lobbies: Hotel Lobby	1.5	
Main Entry Lobby	1.0	
Malls, Arcades, and Atria	0.8	
Medical and Clinical Care	1.2	A.R.
Office	1.0	1.8
Precision Commercial and/or Industrial Work	1.3	A.R.
Religious Worship	1.4	
Retail Sales, Wholesale Showrooms	1.4	
Theaters: Motion Picture	0.7	
Performance	1.0	A.R.

\* AR means "as required"

**Part 2 – Products**



- Light fixtures are to be the product of a manufacturer of high quality light fixtures generally used in an industrial or commercial type setting. Fixtures shall be UL or CSA listed and certified.
- Fluorescent fixtures shall utilize electronic ballasts (not hybrids). Ballasts shall be Advance, Universal/Magnetec or prior approved equal as manufactured. All ballasts shall be fused with glass tube fuses type HLR/GLR. All ballasts shall be CBM certified. Crest factor shall be not greater than 1.7. Harmonic distortion shall be less than 10%.
- Linear fluorescent lamps for 4' or 8' fixtures shall be type T8 32 watt 4 ft. lamps (tandem 4' lamps in 8' fixtures) energy saving lamps and shall be compatible with the type of ballasts supplied (and must be certified as such by both the manufacturer of the lamps and the manufacturer of the ballasts).
- Lamps shall be 4100°K with a CRI of 85. New buildings shall utilize 4100°K lamps. Lamps shall be rated for 24,000 hrs. minimum. Lamps shall be non-hazardous and disposable by normal means.
- For smaller than 4' lamps it is recommended that compact biax lamps be utilized rather than the use of u-tube type lamps. (36 watts and higher wattage Biax are not approved.) (48" U tubes are not permitted.)
- Ballasts should be installed such that they are contained within the fixture. Where this is not possible the ballast should be installed clear of any combustible material and in an accessible location. Ballasts for recessed non-linear type fixtures shall be located between the fixture housing and the junction box.
- Where HID type fixtures are used utilize ballasts without igniters and specify that the igniter be integral with the lamps.
- All ballasts for HID fixtures shall be high power factor/low noise/low emf type ballasts.
- Compact fluorescent ballasts shall be highest quality, HPF, minimum THD and maximum efficiency.

### Part 3 – Execution

- Light fixtures shall be installed so that they are accessible for maintenance.
- Reference 16190 for supports.
- Fixtures mounted in a plaster or drywall type ceiling shall be rigidly supported in an approved manner using channels connected to the ceiling support system
- Provide plaster frames for all fixtures requiring them.
- Light fixtures mounted flush in fire rated walls or ceilings shall be rated to the wall/ceiling rating.
- 3/8" light fixture whips may be utilized when fixture whip comes from the factory attached to the fixture via a steel box connection. Wire size shall not be less than #14 THHN. Box connectors must have a locknut, i.e., pop in type connectors will not be permitted. Lengths shall not exceed 6'0". (Tandem whips may be longer with University approval.)
- Removable snap in entrance fittings shall be secured to the fixture body using a #8 (minimum) self tapping screw.
- 2x2; 2x4; 1x4; 1x6 and 1x8 types of light fixtures including recessed can type fixtures installed in grid ceilings shall be supported using not less than #12 gauge steel galvanized support wire and earthquake clips shall be installed. Each rectangular or square type fixture shall have a minimum of two support wires attached at opposite corners. Each recessed can type fixture shall have a minimum of one support wire. Support wires shall be secured attached directly and independently to the building structure with minimum size ¼" galvanized steel anchors (use expansion type anchors when in concrete). Wires shall have a minimum of

three twists (turns) at each attachment point. Deflection on the support wires shall not exceed 10-degrees from plumb. Refer to Section 16190 – Supports – LIGHT FIXTURE SUPPORTS.

**End of Section 16510**

## DIVISION 16 - ELECTRICAL

### Section 16530 - Site Lighting

#### Introduction

When designing site lighting for the University two areas of major concern arise. The first and most prominent is that of safety for the students and faculty members. Since many times students need to be out and around the facility at late hours it is important to provide lighting such that they can see well enough to feel safe when they are traveling from one building to another.

The second area of concern is to minimize site lighting so as to meet within the guidelines for both Kitt Peak and Mt. Hopkins Observatories.

Lighting design should be in keeping with IES Lighting Standards *and the Pima County Lighting Ordinance. Follow the ordinance. Special situations may receive a variance. Submit written requests to FDC for written approval.*

As a part of the design we expect to see details of both bollard and light pole foundations. *Foundation designs shall be sealed by a Structural Engineer.*

***Metal halide shall not be used unless approved by UA, FDC Electrical Engineer or UA, FDC Electrical Inspector.***

*Low pressure sodium sources are not to be used. High pressure sodium, fully shielded is the preferred source.*

Whenever rework in the existing series street lighting is accomplished we should make an aim to eliminate the 2300 volt circuit and rewire to be powered by the nearest building. In addition label each pole base inside as to the source of the power.

Light fixtures should be located in such a manner that they can be easily maintained using standard equipment. Where fixtures can not be easily accessed the use of hinged poles shall be required. All exterior building light fixtures and poles shall be readily accessible and not restricted by other site improvements.

The design should be made in a manner such that is both energy efficient and cost effective as well as meeting the requirements for the local regulations.

The design should be flexible for both the field installation for expansion and for maintenance.

Where large areas are involved provide handholes for maintenance use to trouble shoot the underground wiring when needed, and to allow for easier expansion if required in the future.

As part of the design development phase provide cut sheets and point to point design calculations for all site lighting.

Where site lighting is to be designed either on the fringes of campus or off campus, insure that no light trespass occurs.

#### Part 1 - General

- Provide submittals on all fixtures, including poles, bases, and ballasts.

## **Part 2 - Products**

- Provide high quality products which are both architectural in nature and have an efficient lighting design.
- Use enough fixtures to provide adequate light especially in exterior corridors or areas between buildings to allow proper levels for personnel safety.
- Where available match fixtures in surrounding areas to be able to allow some continuity with the lighting in a general area.
- Light poles need to be designed for a minimum of a 100 mph wind loading. (80 mph + 1.3 gust factor)
- All fixtures with ballasts shall be fused.
- Pole mounted fixtures shall have fuses in base of pole with handhole access.
- **Part 3 - Execution**
- Include requirements for aligning light fixtures, light poles, and bollards to be both level and uniform in layout and light distribution.

**End of Section 16530**

## **DIVISION 16 - ELECTRICAL**

### **Section 16535 - Emergency Lighting**

#### **Introduction**

Provisions for emergency lighting should take into consideration the requirements for location of emergency exit lights in accordance with the new ADA and the requirements of the NFPA for exit lights.

In general for new buildings it is required that all emergency lighting be supplied through the use of an electric generator. Each floor should have its own emergency panel and all emergency lights should be supplied from that panel.

On existing buildings where an emergency generator exists, all new emergency lights should be connected to that system. On buildings without an emergency generator system utilize 2 hour emergency battery packs in fixtures where required.

Do not wire light fixtures with power from two different emergency power systems.

For corridor emergency/night light circuits consider using florescent fixtures with PL type lamps at either 13 or 26 watt levels.

Emergency lights located in classrooms or labs where a fully lit fixture would cause problems with the capability to darken the room (where a dark room is necessary for the room's operation) shall be switched via a lighted red toggle switch.

#### **Part 1 - General**

- Provide submittals on all emergency light fixtures.

#### **Part 2 - Products**

- Emergency or exit lights shall be the LED type low power use.
- Clear plexiglass exit signs, if used, shall have factory backings to prevent reading the words backwards.
- Battery packs should use the Nicad type batteries with a minimum of 10 year life.
- Where emergency lights contain battery packs the emergency ballast shall be as manufactured by Iota or approved equal.
- Fluorescent fixtures with 4 ft. lamps shall utilize 1000 lumen battery packs when battery packs are permitted.

#### **Part 3 - Execution**

- Where used in classroom situations it is generally considered that all emergency lights should be capable of being turned off via normal light switches. However in case of an emergency or loss of power, and where possible they should all be energized to illuminate the means of egress. Emergency lights should be supported by the same criteria as normal light fixtures.

#### **End of Section 16535**

## **DIVISION 16 - ELECTRICAL**

### **Section 16580 - Theatrical Lighting**

#### **Introduction**

Since theatrical lighting is a very specialized lighting system it should be left to be designed by experts in this field of lighting. On projects such as this it is required that the engineer responsible for this area of design be experienced in this type of design and should provide documentation in the form of past projects engineered which would back up his claim.

Documentation required on this type of design would be providing a minimum of two proposals for the type of design proposed. Each should include back up information such as type of equipment planned (including cut sheets), typical life expectancy of equipment (including bulbs and ballasts where applicable), and cost estimates for each type of lighting system.

Design should take into account the requirements of maintenance on the system and the reliability of the equipment. For this reason we would expect to have included in the design high quality equipment by the top manufacturer's of this type of equipment.

Theater design should include design calculations and computer printouts on a point to point basis. Cut sheets of intended products shall be provided at the design development phase.

The electrical consultant shall supervise the lighting design and seal the plans.

#### **Part 1 - General**

- Complete submittals of all equipment proposed should be provided.
- Maintenance and operational manuals should be provided (minimum of 4 sets) at completion of project.

#### **Part 2 - Products**

- All products should be the product of top quality manufacturers and should be designed for the purpose for which it is used.
- All products should be U.L. listed or certified.

#### **Part 3 - Execution**

- All equipment should be independently supported to a minimum of a 200% safety factor to the building structure.
- All equipment should be located such that it is accessible for maintenance or can be made available for maintenance through normally available methods.

#### **End of Section 16580**

## **DIVISION 16 - ELECTRICAL**

### **Section 16610 - Uninterruptable Power Supply Systems**

#### **Introduction**

The design of UPS systems is normally associated only with specialized computer room distribution systems. At the present most of these systems are not associated with the renovation of any building or facility, but rather a piece of equipment that would be provided by the user as a separate item. However where they are to be provided by the contractor as a part of the construction package the following guidelines should be taken into account for the design.

- A minimum of a 20 minute battery backup should be used.
- Only static UPS units should be used.
- Design should provide for a minimum of 30% spare capacity.
- Design should be based on top quality static UPS systems such as those supplied by Liebert, and similar manufacturers.
- Design for the electric service to the unit should take into account the losses for the system.
- Since these units generate a large amount of heat and are usually somewhat noisy it is recommended that they be located in a room where the general public will not normally be working, where there is adequate air conditioning for the required heat load, and where the walls provide a good deal of noise attenuation.

Should this section be required for an actual project please consult with the U of A electrical engineer.

#### **Part 1 - General**

- All systems must be UL listed.
- Provide complete submittals on UPS system including operations and maintenance manuals (minimum of 4 copies).
- Provide for two years of preventative maintenance as a part of the cost of the UPS.

#### **Part 2 - Products**

- To be determined at time of design. Suggested manufacturers to be Liebert or approved equal.

#### **Part 3 - Execution**

- Install units in an area where they are fully accessible for maintenance, and with adequate ventilation.

#### **End of Section 16610**

## DIVISION 16 - ELECTRICAL

### Section 16620 - Standby Power Generator Systems

#### Introduction

The design for emergency power generation takes on two separate designs at this campus. For the typical building at the main campus it is generally used only to provide power to emergency lighting and similar building maintenance type pieces of equipment. In some other buildings additional loads are added for such things as freezers or other types of mechanical equipment which need to be on due to worry about losses of expensive equipment (including some valuable experiments) which are stored in the freezers. However the design for expansions on the AHSC campus sometimes take on a different flavor since it may include areas which could someday become part of the hospital. For this reason it will be necessary to discuss in great detail the design of the emergency generation system with the Engineer, prior to the proposal of the system. As a part of the design the following items should be taken into account:

- In general we *require* the use of Natural Gas to fuel the generators due to *local emissions requirements and ordinances*, ease of delivery of the fuel *and elimination of the need for fuel storage*. With the constant construction around this campus, areas which were once very accessible for delivery of fuel are now very difficult to access. In addition the designer should verify that the source of natural gas which has been designed for the building is adequate for the additional volume of natural gas that will be required during the full load operation of the generator.
- Make sure that the generator will be adequately cooled in case of loss of power to the general building system. It may be necessary to provide additional capacity for the generator just to cover an additional fan coil unit to provide cooling to the generator room if it is located inside of a closed room in the building.
- Provide for adequate exhaust from the building in a location where the fumes will not be sucked into the building air conditioning system during normal or emergency conditions.

In addition it may be decided that some of the emergency generator systems will in the future be used for peak shedding. For this reason it is important that the generator provided be of a top brand of manufacture and designed for more than just an occasional run emergency operation. Engine generators shall be site tested for rated output plus 10% for 1 continuous hour, connected for temperature, based on capability to operate continuously at 115°C ambient. (Refer to base specification.)

As a part of the design development documents, provide a load calculation which is used for providing the basis for the sizing of the emergency generator. Take into account that at least 30% spare capacity shall be provided for in the design of the emergency generator.

As part of the plans design make sure that the required circuits for the battery charger and the engine oil and manifold heaters are shown and provided.

Remote control or annunciation panels shall be shown on the drawings with all wiring required. Show ATS (automatic transfer switch) and all associated wiring on the plans. Fire alarm shall monitor generator run and report to Fire Safety Shop *thru the FACP*.

For your use a copy of an existing specification for an emergency generator specification and an automatic transfer switch have been provided. (See attached appendix specification sections 16620 and 16622). As a minimum all of the areas covered in this specification should be covered. This specification can be provided on disk for your use, however it is still the responsibility of the engineer to provide a complete specification for this design.

Where a building EMCS system is available connect the following items to the system. Building power off, generator power on, generator alarm (a common alarm of all generator alarm functions).



### **Part 1 - General**

- Provide complete submittals on the emergency generator, including at least 4 copies of all operations and maintenance manuals. Submittal information shall include documentation of fuel efficiency based on a KW per pound of gas. This should be provided for evaluation by the engineer prior to approving the use of any brand of emergency generator set.

### **Part 2 - Products**

- The generator should be the product of top quality generator manufacturers such as Caterpillar or Waukesha. Other manufacturers may be considered based on submittal information. The manufacturer should certify that the generator is capable of providing the necessary power for all of the load as designed, including the spare capacity.
- *Engine Generator System shall have a 5 year extended warranty. Whenever the transfer switch manufacturer offers an extended warranty, it shall be included,*
- *The contractor shall provide (2) complete sets of parts and repair manuals for all engine, generator and transfer switch systems and components.*

### **Part 3 - Execution**

- The generator shall be mounted on a housekeeping pad and if in a building shall have a containment area built around to contain any oil or antifreeze spills. The generator shall be installed and connected to meet with the requirements of the manufacturer.
- Provide a resistive load bank test of all generators prior to acceptance. Minimum tests should show all required control options of the generator and transfer switch as well as a one hour load bank test at 80% load and an additional one hour load bank test at 110% load, corrected for temperature of 115° C. Generator shall also be tested in a full load live situation test prior to acceptance.

### **End of Section 16620**

## **DIVISION 16 - ELECTRICAL**

### **Section 16622 Automatic Transfer Switch**

#### **Introduction**

The intent of this section is to require that at each location where an emergency generator system is utilized an automatic transfer switch (ATS) *or bypass isolation transfer switch shall be utilized.*

Since more and more equipment is being added to the system which is "protected" by the emergency generator system it is important that a top quality transfer switch be utilized. In addition it has been found that though many of the manufacturer's of emergency generators can provide a switch in conjunction with the emergency generator that these are usually of a lower overall quality and more subject to breakdown. Therefore we would suggest that the ATS be of similar quality to that in the accompanying specification.

The ATS should be sized to meet both the maximum short circuit current available from the combined sources (in case of a direct fault during transfer), and for 125% of the available current from either the normal or emergency power source *with a 3 cycle rating in excess of UL 1008.*

Since the ATS generally contains electronic items make sure that the location of the transfer switch is compatible (i.e. adequate cooling and minimum dust) with the transfer switch.

A sample specification (see attached Appendix Section 16622) has been provided for your use outlining all of the standard requirements necessary for new installations here. As a minimum all of the items outlined in this specification should be included.

*Whenever GFI is used, provide 4 pole switches.*

*Transfer switch shall have programmable auto exercising feature for once a week*

#### **Part 1 - General**

- Complete submittals and operational manuals shall be provided as a part of the system.
- The warranty shall be the same as that of the emergency generator that it is associated with.
- Complete maintenance manuals and spare parts lists be provided as a part of the project close out documents.

#### **Part 2 - Products**

- Russelectric, or *prior* approved equal. *Zenith and ASCO may be specified after first documenting proof of third party testing for a 3 cycle rating. (Prior to completing contract documents submit proof at design development stage of design).*

#### **Part 3 - Execution**

- Startup and check out to be by a manufacturer's certified technician.

#### **End of Section 16622**

## **DIVISION 16 - ELECTRICAL**

### **Section 16650 - Electromagnetic Shielding Systems**

#### **Introduction**

Electro magnetic shielding is only required when due to the type of testing going on in a building that high levels of electro magnetic fields (EMF) are generated in an area. Typically if personnel are being exposed to levels of EMF higher than 100 mg then electro magnetic shielding should be provided or special consideration should be taken to lower the EMF.

Sometimes it will be necessary to build a specially shielded room for personnel involved in the testing of special systems so as to minimize the amount of EMF and RF (radio frequencies) which would enter the test space.

The design of such a system in either case shall be done only by personnel who are experienced in design of shielded rooms or special shielding facilities. Special grounding systems shall be taken into account to facilitate complete draining of all EMF energies into the ground and thus protect personnel.

#### **Part 1 - General**

- Provide complete submittals for the design whether by the engineering firm or a design build concept is used.

#### **Part 2 - Products**

- All grounding parts shall be copper. Copper shielding shall be utilized in the design. Where required for personnel protection the entire system shall be UL certified.

#### **Part 3 - Execution**

- The installation of the system shall only be accomplished by personnel experienced in the construction of Electromagnetic shielding systems. Following the construction of the system it shall be the requirement of the installer to have the entire system tested to verify that it complies with the minimum design constraints set up prior to the design of the system.
- Foil systems utilizing foil stapled to walls is unacceptable design.
- Consult University of Arizona Engineer for test/compliance of these facilities during design.

**End of Section 16650**

## **DIVISION 16 - ELECTRICAL**

### **Section 16660 - Ground Fault Protection Systems**

#### **Introduction**

All building main distribution systems shall have a ground fault protection system as a part of the secondary main disconnect at the building. This is required per the NEC for services of 1000 amps and larger.

GFI receptacles shall be used for drinking fountains and wherever a receptacle is within 5' of a sink or an emergency shower and where otherwise required by the NEC or good engineering practice.

GFI receptacles shall not be feed through type. Each location required shall have its own GFI receptacle.

It may be necessary to add GFI protection to services where an adequate ground is not available and where danger of electrocution is possible. An example of this would be an overhead crane where only a three wire system has been connected to the service and where the danger of electrocution is greater than the possible danger from loss of power to the overhead crane.

#### **Part 1 - General**

- Provide complete submittals for all devices supplied under this section.

#### **Part 2 - Products**

- GFI relays provided as a part of a main switchboard shall be as recommended by the manufacturer of the switchboard.
- GFI receptacles shall be heavy duty specification grade receptacles similar to Hubbell 5362 GFI.

#### **Part 3 - Execution**

- Install all devices in accordance with the manufacturer's recommendations. For service entrance systems the device shall be tested following installation in accordance with NETA testing standards.
- Each GFI receptacle shall be tested for proper operation following installation.

#### **End of Section 16660**

## **DIVISION 16 - ELECTRICAL**

### **Section 16680 - Variable Speed Drive Systems**

#### **Introduction**

There has been some confusion as to who should specify variable speed drives. Since they are electrical in nature and are maintained by the U of A Electric shop we would like to see them in the electrical specification section in the future.

Since there are some concerns as to what type of drives are recommended for use on this campus we would like to provide the attached sample specification (Section 16680) for your review as to what areas are necessary for inclusion in this specification and also the level of quality which is recommended for use on this campus.

Note that it will be necessary to interface with the mechanical or instrumentation engineer as to what required connections are necessary for the tie into the EMCS or other control system.

Do not locate drive inside of air handling units.

#### **Part 1 - General**

- Require complete submittals including wiring diagrams and recommended spare parts at the submittal.
- Require submission of complete operation and maintenance manuals at time of completion of contract prior to conducting the "training session". Operation and maintenance manual shall contain a complete copy of the submittal documents.
- Require a factory representative startup and training on site four hour minimum training session to be scheduled after the VFD is in service and fully operational.

#### **Part 2 - Products**

- ABB or prior approved equal meeting the aforementioned specification, type ACH 401.
- Indoor enclosures shall be NEMA 12. Outdoor shall be NEMA 4.
- Fully transistorized PWM type drives.
- Match type of drive to actual load driven (i.e. variable torque or constant torque)
- Coordinate use of VFD rated motors with mechanical trade.

#### **Part 3 – Execution**

- Utilize Mechanical section 15870 in coordination with the mechanical trade and /or engineer.
- Limit length of feeder from VFD or AFC (adjustable frequency controllers) to motor as per recommendations of the manufacturer. If possible locate drive near motor.
- Feeder must be in steel conduit.
- Control wiring in separate steel conduit. Speed signal wiring to be in twisted shielded pair, minimum of 18 ga. copper.
- Install AY.

#### **End of Section 16680**

## **DIVISION 16 - ELECTRICAL**

### **Section 16700- TELECOMMUNICATIONS**

#### **Part 1 - General**

- The scope of this project includes providing all material and labor to install a complete telecommunication system. The systems shall include building entrance cables, riser cables, station wiring, terminations, and termination devices and grounding.
- In any case where the specifications or drawings are not perfectly clear to contractors submitting a proposal, it is the responsibility of the contractor to obtain clarification from UITS-NTS Engineering. The drawings are diagrammatic and are not complete in every detail. The contractor shall be responsible for determining how to perform indicated work under the scope of the project and shall not make any additional charges for any work or material required for a complete installation. The drawings and specifications are complementary, and what is called for on one shall be binding as if called for by both.
- Coordinate size and location of communication rooms with the architect to be in compliance with this document and NEC Art. 800 © (2002).
- In projects where “Blue Light” emergency phones are required, refer to Section 16705, Blue Light Phones.
- Refer to project plans and specifications for grounding and power requirements.
  
- **General Requirements**
  - **Codes & License Compliance:** The completed installation shall be in compliance with all applicable electrical and fire codes and ordinances, the Williams-Steiger Occupational Safety and Health Act of 1970, and University Standards. Telecommunications contractor must have a current L67 Low Voltage Communications Systems license, and have held the license for a minimum of 4 years, and be listed by the University as an approved telecommunications cabling contractor.
  - **New & Listed Materials:** All materials shall be new and shall be listed as being suitable for the purpose by Underwriters Laboratories, Inc. or equivalent testing agency known to and approved by the University.
  - **Workmanship:** All work shall be executed according to these specifications in a workmanlike manner and shall present a neat mechanical appearance when complete.
  - **Quality Assurance:** At least one person directly employed by the prime contractor shall monitor the daily activities of workers to assure the quality of the work performed.
  - **Acceptance Inspection:** All work must pass functional and workmanship inspections prior to acceptance. The contractor shall make all required corrections, at no additional cost, before the system is put into service.
  - **Clean up & Repair:** Contractor shall be responsible for clean up and repair of job site. Damaged false ceilings, pencil or chalk marks, hand prints, gouges and tool makers, plaster dust, etc. shall be repaired, cleaned, removed, or painted as required. Penetrated fire barriers shall be resealed in an approved manner.
  - **Submittal:** (5 copies required). Complete materials lists, manufacturer’s literature, required drawings, and other required information shall be submitted for approval no less than 10 working days before such materials are required to be ordered for the work. UITS-NTS Engineering must approve submittal prior to starting the installation. Submit thru the Construction Project Manager.
  - **Guarantee:** Upon completion of the work and acceptance by the University, the contractor shall submit his warranty effective for one year guaranteeing to replace without additional cost to the University any work or material which develops defects.
  - **As-Built Drawings & Documents:** The contractor shall maintain daily up to date specifications and drawings. The contractor shall submit to UITS-NTS a complete set of As-Built drawings showing the location and identification number of all jacks installed as part of the project. As-Built drawings shall be submitted in both hard-copy and AutoCAD format.
  - **Changes:** No changes shall be made from the work as called for by these specifications and drawings, except by a written order approved by the project Construction Project Manager, Architect, and UITS-NTS Engineering.
  - **Splicing:** All cable splicing must be done by a qualified cable splicer, with a minimum of 5 years experience splicing large pair count copper cables. The cable splicer’s name and qualifications must be

submitted to UITS-NTS Engineering for verification and approval prior to any splicing work. Provide a minimum of 48 hours advance notice to UITS-NTS prior to performing any splicing to existing campus cabling infrastructure.

- Coordinate grounding requirements with Specification 16450.

## Part 2 - Description of Work

- Building Entry Cable: Supply, install, splice, and terminate the required multi-pair building entrance cable and or fiber optic cable routed as shown on drawings. Supply and install station protectors and grounding in accordance with NEC requirements.
- Entrance Facilities:
  - Vertical cable runs are to be supported at a maximum of 5 ft. centers. Horizontal cable runs are to be supported at a maximum of 3 ft. centers.
  - Copper entrance cables shall terminate on a rack mounted protector panel. Optical fiber entrance cables shall terminate on a rack mounted optical fiber enclosure (LIU).
  - Supply and install 4' x 8' x 3/4" A-C plywood backboards in communications equipment rooms as shown on drawings. All walls within the telecommunications rooms shall be covered with plywood. **Plywood shall be treated on all sides with at least two coats of white paint.** Paint shall be fire resistant type if plywood is not.
  - Terminal blocks shall be permanently marked with pair count numbers for entry cable terminations. Horizontal station cable termination's shall be marked with final University room numbers. Obtain entry cable and riser cable pair count information from UITS NTS Engineering.
  - Entry cables are to be terminated starting with lowest pair count, left to right, top to bottom. Horizontal station cables are to be terminated starting with the lowest room number, left to right, top to bottom.
  - Metal closed loop D-rings (2, 4, and 6 inch as required) shall be installed in quantities sufficient to produce an orderly quality cable and wire installation. Distributing posts are not acceptable.
  - Cables shall be routed in such a way as to minimize interference with cross connect wiring and future equipment additions. D-rings shall be utilized to route cable away from the top and bottom of the terminal blocks. Entrance cable shall be routed to and terminated to the bottom group of termination blocks. Horizontal distribution cables shall be routed to and terminated to the top group of termination blocks.
  - Cable management D-rings, brackets, and horizontal and vertical cable managers shall be installed to maintain an orderly appearance for cable or wires running between backboards or to common equipment.
  - Transition splice cases and riser cable splice cases are not considered part of a TTB, and shall be located so as not to interfere with backboards or common equipment.
  - All wall mounted equipment shall be securely fastened to the TTB/DTB. Suspension by connection to other equipment is not acceptable.
  - Complete telecommunication room layout drawings shall be included as part of the project submittal. Layout shall be designed to allow all four walls of the telecommunications room to be used for mounting telecommunications equipment.
  - All fiber optic connectors shall be ST ceramic tip type.
  - All fiber optic cable splicing shall be done using the fusion splice method.
- Station Wiring:
  - Provide a quad frame for each outlet, with blank inserts provided for unused openings. A standard outlet shall consist of a quad frame with two jacks horizontally aligned, and two blank inserts.
  - HORIZONTAL STATION WIRING MUST BE IN COMPLIANCE WITH EIA/TIA-568B HORIZONTAL WIRING DISTANCE SPECIFICATIONS. The maximum horizontal cable length shall be 90 meters (295 ft). This is the cable length from the mechanical termination of the media in the telecommunications closet to the telecommunications outlet in the work area. The distance maximum includes all wiring that is part of the horizontal wiring. Provide 12 in. of cable slack at each outlet, plus an additional 10 ft. of slack in the telecommunications room, neatly arranged in a loop above (not on) the TTB.
  - Station wiring and termination equipment shall be rated Category 6.

- Outlet jack shall be an eight position modular jack meeting the specifications of FCC Regulations Part 68.500. All jacks shall be wired according to the T568B wiring schematic.
- Station cable must not be spliced. Cable runs are to be direct home runs to the IDF and shall not pass through any other station outlet box. The cable bend radius for station cabling shall not be less than four times the outside diameter of the cable.
- Install cables in conduit, and raceways as specified and supplied and installed by the electrical contractor. All conduits and sleeves shall have insulated bushings installed to protect wire and cables from damage. Installed cables shall not be bundled together.
- Station cable and wiring shall comply with EIA/TIA 568B, standards. (UTP Category 6)
- Install and terminate fiber optic cable as shown on drawings.
- All network outlets shall terminate in the IDF that is on the same floor level as the outlets.
  
- Wiring Practices:
  - Station cables shall terminate on a rack mounted patch panel, in a single unified field (no separate voice and data fields).
  - Cable and wire above ceiling shall be run parallel or perpendicular to the walls. Diagonal runs will not be accepted. Riser cables shall be run parallel to riser system. Do not install cables in close proximity to fixtures or equipment that may cause RFI or EMI. To reduce the effects of EMI, the following minimum distances shall be adhered to:
    - 5" from power lines of 2kVA or less.
    - 18" from high voltage lighting (including fluorescent).
    - 39" from transformers, motors, and power lines of 5kVA or greater
  - Cables and wire shall not be attached to conduit, pipes, ceiling grid/hanger wire, light fixture hangers, HVAC duct work, etc.
  - All horizontal UTP cable shall be pulled by hand. During pulling operation, an adequate number of workers shall be present to allow cable observation at all points of raceway entry and exit, as well as the point at which cable is "payed out" from the box or reel.
  - Pull cables in accordance with manufacturer's recommendations and ANSI/IEEE C2 Standards. Manufacturer recommendations shall be part of cable submittal. Recommended pulling tensions and bend radius shall not be exceeded. Any cables bent or kinked to radius less than recommended dimensions are not allowed and shall be replaced at no expense to the owner.
  - Cables that show signs of being bent or kinked beyond recommendations then straightened are also not allowed and shall be replaced at no expense to the owner.
  - Cables that show damage to the jacket in any manner shall be replaced at no expense to the owner.
  - Cable and wire above ceiling shall be suspended from approved hangers as required and be routed as close to upper ceiling as practical. Supports shall be installed at a maximum of 3 ft. centers. Metal "J" hangers are the approved hanger type.
  - Ground entrance cable shield to an approved provable ground as close to the entrance as possible.
  - All telephone boards and cabinets must have a No. 6 AWG minimum copper wire from an approved ground as specified on the drawings to the telephone backboard or cabinet. Terminate ground wire to a 6 inch copper buss bar which has provisions for additional ground connections.
  - Conduit fill: In new installations, conduit fill shall not exceed 50%. In retrofit installations, conduit fill may exceed 50% provided that the necessary pulling tension does not exceed the cable rating, and that compression of the cable jacket does not occur. **Note:** Fill requirement does not apply to outside cable plant or building entrance cable installation.
  - All conduits and sleeves must have UL approved insulated end bushings installed prior to installation of cables or station wire.
  - All riser sleeves/conduits and penetrations of fire rated partitions shall be fire stopped using approved methods and materials.
  - All cables shall be installed in compliance with manufacturers pull tension and bend radius specifications. Station cable (voice & data), shall have individual pair twists preserved to point of termination. Cable jacket and inter-pair twists shall be continuous to within ½" of termination. Cables should not be routed in tightly cinched bundles. Avoid over-tensioning or twisting cable during installation.
  
- Wall boxes shall be flush mounted, standard metal 4 inch square, deep type, with a single gang plaster ring.



Conduit from the wall box shall be concealed and stubbed out above accessible ceiling, to riser closet, or to the telecommunications cable tray. Conduit shall be 1" minimum. Conduit end shall be fitted with a UL approved insulated bushing.

- Any additional service requirements that will not operate over the standard University building telephone/data wiring shall use a completely separate conduit and wall outlet.
- Labeling:
  - All labels shall be machine generated (printer or handheld label machine).
  - All cables shall be permanently identified at both ends.
  - The labeling for outlets shall consist of three components: (1) a unique sequential numeric designation for each jack/cable, (2) an alpha-numeric designation for the telecommunications room serving the outlet, and (3) the final University room number. At the station end, the faceplate of each outlet shall be labeled with the alpha-numeric telecommunications room identifier, plus the sequential numeric jack/cable identifier, as shown on the diagram below. At the telecommunications room end, the patch panel shall be labeled with the final University room number, plus the sequential jack/cable identifier. A label with the sequential jack/cable identifier shall be applied to each end of the station cable within 6 inches of the termination.

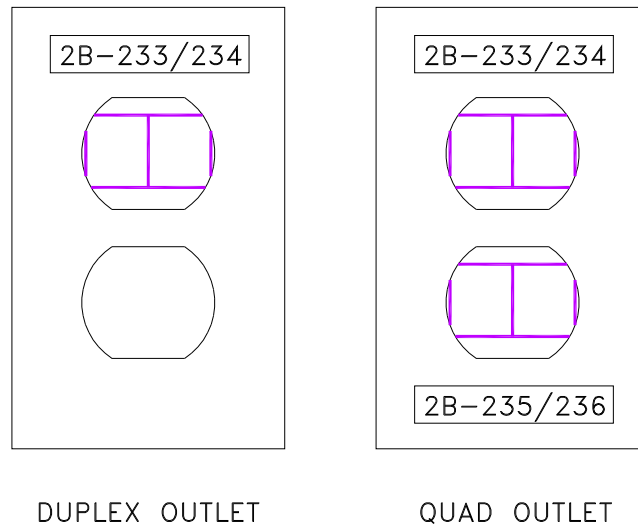

Faceplate Labeling Diagram

- Fiber optic riser cables shall be labeled utilizing a unique sequential numeric designation for each strand within a given building. Couplers and coupling panels shall be grouped by type of fiber, adjacent to each other either vertically or horizontally depending on make up of LIU, with a designation indicating "SM" for single mode and "MM" for multimode. Each LIU in an IDF shall be labeled with the unique numeric strand designations, and labeled with the originating end Equipment/BET Room designation (alpha-numeric identifier). The LIU(s) in the Equipment/BET Rooms shall be labeled with the unique numeric strand designations, plus each group of fibers shall be labeled with the remote end IDF Room designation (alpha-numeric identifier).
- **Prior approval of final labeling scheme must be received from UITS-NTS. Labels shall be applied at the time of cable acceptance testing.**

### Part 3 - Products

- Materials List:

All items not specifically covered in these specifications must have the concurrence of the University UITS-NTS Engineering Department before placement or implementation.

- Building entry cable shall be 24 AWG solid, REA color code, number of pairs as required. Lucent spec "ANMW", ASP type underground cable. (Transition splice to non-filled cable required prior to BET termination.)
- Station wire: 4 pair, solid conductor, REA color code, plenum rated, UL Listed type "CMP" w/FEP insulation. Cable must comply with EIA/TIA 568B. NOTE: Cables not having FEP insulation on all four pairs are not acceptable. Approved station cables are: Belden 7882A Cat. 6, Berk-Tek LanMark1000 Cat. 6, Superior Essex DataGain Cat. 6. Cable jacket shall be violet in color.
- Cable hangers: Caddy Category 5 CableCat "J" hangers.
- Splice Case: as required and approved by submittal.
- Termination blocks: rack mount, Cat. 5e, Panduit #P110B100R2.
- Patch panels for station cabling: angled modular patch panels, Panduit #DPA24688TGY (24 port), Panduit #DPA48688TGY (48 port).
- Patch panels for riser cabling: flat, modular snap-in type, Panduit #CPPLAWBL, populated with violet Cat. 6 jacks.
- "D" Rings: Lucent 13A (2 in.), 13B (4 inc.), 13C (6 in.) (for use in telecom rooms for vertical cable management only).
- Cable runway: 12" minimum gray tubular steel, with associated mounting, support, junction, and splice hardware. Chatsworth Products Inc. #10250-12 or equal.
- Cross connect wire: 2 pair, 24 awg, solid, copper, REA color code, polyethylene or PVC insulation. NOTE: Must be rated category 5e
- Connecting blocks:       Cat. 5e: Panduit P110CB4, P110CB5  
                                  Cat. 6: Panduit GPCB4
- Telephone/Data outlets: Cat. 6: Panduit CF1064EI frame, with CMBEI blank modules and CJ688TGVL jacks. All jacks shall be violet in color.
- Outlet cover plate: all cover plates shall be stainless steel, Pass & Seymour #SS8 (single gang), #SS82 (double gang).
- Wall telephone outlet: Panduit, KWP6P stainless steel phone plate with Giga-TX style CAT 6 keystone jack module
- Surface mount jack enclosure- use for bluelight phone jacks, wireless access points: Panduit #CBX2.
- Blank cover plate: Pass & Seymour #SS14 (single gang), #SS24 (double gang).  
NOTE: Blank telephone style cover plate shall not be used.
- Cable Protector: Circa #1900A1-100 with cable stubs in/out (100 pr.).
- Plug in Protectors : Avaya (Systimax) 4B1EW
- Fire Stop – sleeves shall be STI EZ-Path, Wiremold FlameStopper, or prior approved equivalent. Caulks and sealants shall be as manufactured by STI, 3M, Nelson, or approved equivalent.
- Cable shield connector: 3M Scotchlock #4460, 4460-S
- Bonding & Ground cable/wire: Ground Wire - No.6 AWG minimum, Bonding Cable - No.6 AWG rated Flexible braid with eyelets. Insulated ground wire shall have insulation that is green in color.
- Splice case filling compound, re-enterable type: 3M 4442.
- Heat Shrink Tubing: Highly Flame Resistant, semi rigid, polyvinylidene fluoride (Kynar).
- Cable Ties: Plenum type where required by code – Panduit hook and loop type.
- Fiber Optic enclosures: All associated hardware shall be provided, including ground clamp, labels, vertical troughs, horizontal troughs, connector panels, blank panels, etc.
  - Fiber Optic Connector: ST type with ceramic tip 3M 6100 (MM), 3M 8100 (SM)
  - Fiber Optic Riser Cable shall be OFNR or OFNP, tight buffered. Multimode shall be 62.5/125 micron, with minimum guaranteed gigabit Ethernet performance distance of 300m at 850nm and 550m at 1300nm. Singlemode shall be 8.2/125 micron, 900 micron, with maximum attenuation of 1.0dB/km at 1310nm and 0.75dB/km at 1550nm. Approved cables are Corning Cable Systems MIC series, Optical Cable Corp. DX series and Commscope Premises Riser Distribution series. All singlemode optical fiber cable shall use Corning SMF28e glass. Riser cables shall be terminated in rack mount enclosures, Panduit FRME Series, with FAP6WST (multimode) and FAP6WSTZ (singlemode) adapter panels.

- Fiber Optic Entrance Cable: Entrance cables shall be Corning Cable Systems Altos Armored loose tube gel-free, interlocking armored cables, indoor/outdoor riser rated, singlemode 8.2/125 Micron, 900 Micron buffered with a minimum LED bandwidth 1500/500 Mhz\*km (singlemode). Entrance fiber shall be terminated on a rack mount enclosure, Panduit #FT124MC with CMSTEI and CMSTZBU adapters.
- Surface raceway: Steel or aluminum only. Wiremold 2100 or approved equal is the minimum size acceptable; larger sizes may be required based on the size and number of cable and jacks to be accommodated.
- Two post equipment racks: provide 7 ft. x 19" freestanding steel equipment rack, B-Line #SB-506-084-U-TG or approved equal.
- Vertical cable managers: freestanding equipment racks shall be provided with 7' high, double-sided cable managers 6" or 10" as indicated on the drawings, Chatsworth MCS Series.
- Horizontal cable managers shall be provided as shown on the drawings. High capacity cable managers shall be Panduit #NCMHAEF4. Standard size cable managers shall be Panduit #NCMHF1. Small cable managers shall be Panduit #NCMHF1.
- Blank filler plates for equipment racks shall be Panduit #CPAF1BLY, provided one per freestanding equipment rack as indicated on the drawings.
- Four post equipment racks shall be 7 ft. high, 19" EIA width, 29" depth, Chatsworth #50120-X03.

#### Part 4 - Telecommunications Room

- General Requirements:
  - Equipment racks, cable runway and other conductive equipment shall be grounded with a minimum #6 AWG connection to the ground bus in each
  - Install floor tile or seal the concrete floor to avoid dust.
  - The minimum recommended ceiling height is 8 feet, 6 inches.
  - When ceiling distribution systems are used, design the closets with adequate conduit or openings through beams or other obstructions into the accessible ceiling space.
  - Design doorway opening with a minimum opening of 3 ft. wide and 6 ft. 8 inches high.
  - Hinge door to open outward.
  - Closet shall not have a false ceiling.
  - Locate the closets in areas above the threat of flooding.
  - Provide a No. 6 AWG minimum ground wire in each closet. Terminate ground wire to a 6 inch copper buss bar which has provisions for additional ground connections.
  - Design lighting to provide a minimum equivalent of 50 foot candles measured at 1 meter AFF.
  - Closets shall be keyed to the restricted campus telecommunications key plan and be accessible only to authorized personnel.
  - If possible locate riser closet in the center of the building or within 150 feet of each tenant space. Multiple riser closets may be required on each floor.
  - Provide fire stops for raceway and pathway systems as required by code. Putty type fire stop material is to be used as required for all conduits and sleeves.
  - In a multi-floor building the closets shall be aligned vertically. Locate closets so building structure beams and other trades equipment does not interfere with placing riser sleeves/conduits within six inches from wall.
  - Minimum size for floor (IDF) riser closets shall be 9 ft. x 11 ft.
  - Minimum size for main (BET) Building Entrance room shall be 10 ft. x 12 ft.
  - Line all walls with 3/4 inch, 4 ft. X 8 ft. A-C grade plywood. Plywood shall be treated on all sides with at least two coats of fire resistant paint (white).
  - Provide a minimum of one 20A/120V duplex receptacle on each wall of each telecommunications room. Provide a minimum of two 20A/208V L6-20R and one 30A/208V L6-30R receptacles in each telecommunications room. In telecommunications rooms containing more than 192 station cable terminations, provide two additional 20A/208V L6-20R and one 30A/208V L6-30R receptacles. **NOTE:** In buildings with emergency power systems, half of the 120V equipment outlets, half of the 20A/208V outlets, and all the 30A/208V outlets are to be connected to building emergency power.
  - Locate riser sleeves/slots on the immediate left side of the closet. This will enhance the use of wall space

from left to right.

- Riser sleeves/slots shall be aligned vertically from floor to floor.
- Riser sleeves/slots shall be: (4) 4 inch sleeves or 4 in. by 16 in. slots. Additional sleeves may be required in large buildings. All riser sleeves shall have bushings installed for cable protection. Sleeves shall extend 4 inches AFF.
- Provide fire stops for cable tray system and riser system as required by code. Putty type fire stop material is to be used as required for all conduits and sleeves. Pillow type fire stops are only acceptable for cable tray penetrations.
- Closets shall be dedicated to telecommunications equipment and shall not be used as a passageway to other utility rooms. Energy management systems, fire alarm, sound systems, and HVAC control systems equipment shall not be located in the telecommunications closet.
- Closets are not to be used for HVAC, plumbing, or electrical risers systems.
- Closets shall not be used for storage or for janitorial equipment.
- User equipment requiring an attendant, monitoring, or frequent attendance shall not be placed in equipment rooms.
- All telecommunications rooms shall be served by the building HVAC system. Temperature with telecommunications rooms that will house active equipment shall be maintained within the range of 64 to 75 degrees F, at 30-50% relative humidity. Telecommunications rooms shall have dedicated environmental controls, providing conditioning 24 hours a day, 7 days a week.

#### **Part 5 - Acceptance Testing**

- End-to-end testing of all cable pairs, optical fiber strands, and coax cables shall be performed after completion of installation and termination. UTP Category 6 station wiring shall be in compliance with the EIA/TIA 568B standard. Cat. 6 systems shall be tested to Level III accuracy. Labels shall be applied at the time acceptance testing is performed.
- Cable testing shall be performed using Fluke DSP-4000 Series or Fluke DTX series test equipment.
- Copper station cable tests shall be "Permanent Link" tests, performed with the appropriate test adapters/cords. "Basic Link" and "Channel" tests are not acceptable.
- End-to-end attenuation testing of each optical fiber strand shall be made using an optical power meter and optical light source. Multimode fibers shall be tested at 850 and 1300nm. Singlemode fibers shall be tested at 1310 and 1550nm. Attenuation tests shall be performed in both directions. Outside plant backbone cables that are greater than 100m in length shall also be tested with an OTDR.
- UITS-NTS must approve test documentation. Documentation shall be submitted in Fluke LinkWare Database electronic format.
- Test result documentation shall indicate the final cable/outlet number assigned to each item tested, as well as identify the project and the telecommunications room serving each item tested. The test result submittal shall be organized by telecommunications room, with the test results in sequential order based on jack id. Test results that are incomplete or that are not organized in sequential order will not be accepted.

#### **Part 6 - Cable Tray System Design Guide Minimum Requirements**

- Cable trays are for the containment of telecommunications cables and shall be installed in accordance with applicable electrical codes. Cable tray shall be bonded to ground.
- System shall be designed and installed to allow accessibility for adds, moves, and changes.
- A standard prefabricated ladder type cable tray consisting of solid side panels and side rails connected by individual transverse members, or an approved wire basket type tray shall be used. The approved wire basket type trays are Cablofil EZTray and GS Metals Flextray.
- Ladder type trays shall use standard prefabricated elbows, reducers, crossovers, tees, and elevation change tray sections as required.
- Trays may be supported by cantilever brackets, trapeze, or individual rod suspension. Supports shall be installed on five foot centers maximum. A support shall be placed within two feet on each side of any connection to a fitting. Center hung supports shall be used only with prior approval from CCIT-NTS Engineering.

- The inside of the cable tray shall be free of burrs, sharp edges, and projections that can damage cable insulation.
- A minimum of 12 inch access headroom shall be provided and maintained above the complete cable tray system. Cable trays must have adequate side access for initial cable installation and for future cable adds, moves, and changes.
- Cable tray “tees” and 90’s shall have wide radius junctions.
- Care should be taken to ensure that other building components do not restrict access to the cable tray.
- Cable tray shall be level and have supports if required to prevent horizontal movement.
- System shall be designed and installed to allow compliance with EIA/TIA-568B horizontal wiring distance standards.
- Fire wall penetrations must be sealed with an approved design tested fire-stopping system installed in accordance with manufacturer’s instructions. Use of pillow type fire stop material is acceptable only for cable tray penetrations.

#### **Part 7 – Demolition**

- All abandoned cables within a project’s boundaries shall be completely removed back to the termination block.
- Tele/data outlets shown on demolition drawings to be removed shall be removed completely including outlet and wiring to the originating IDF termination point. Termination labels shall be revised to reflect all changes.



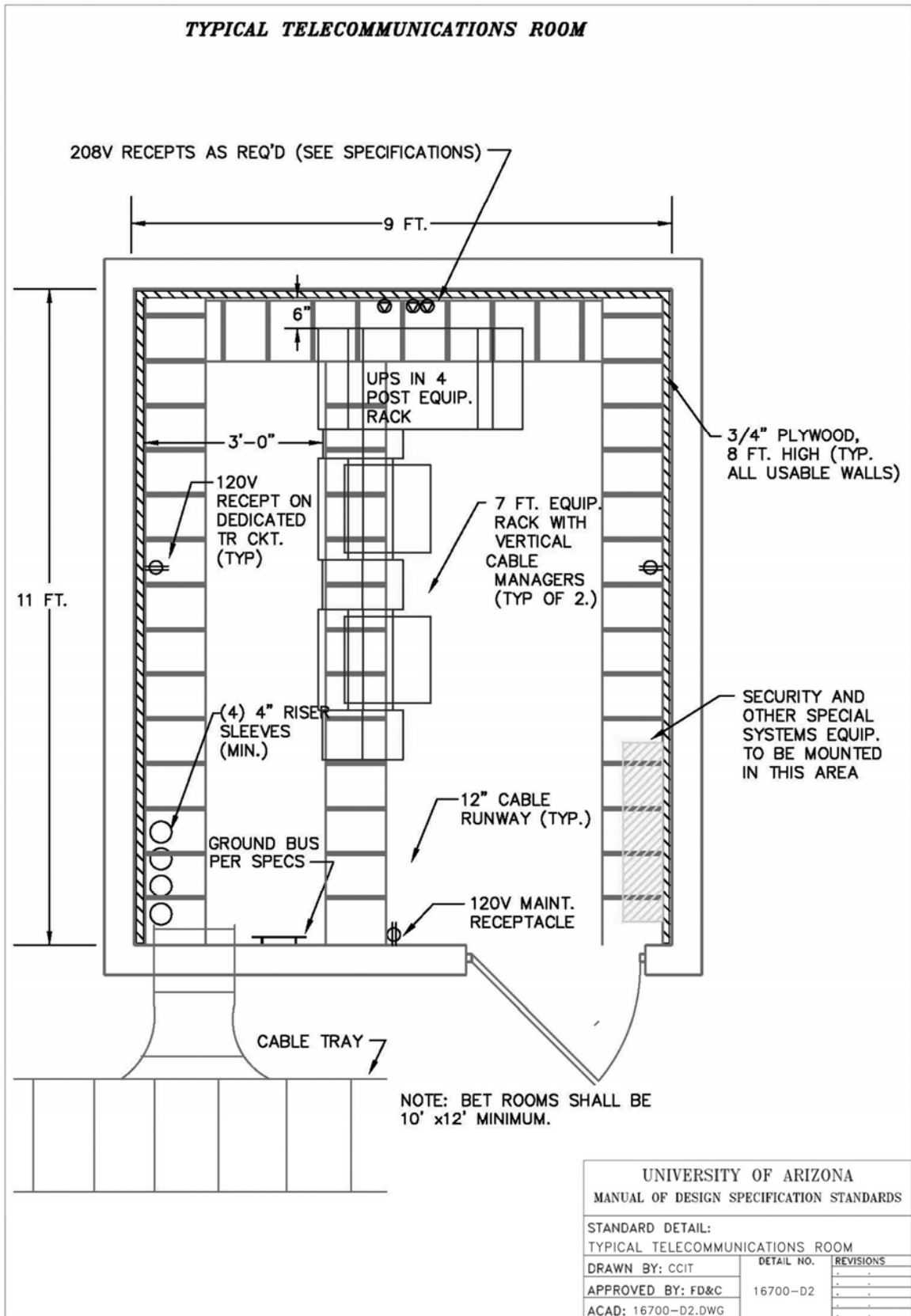

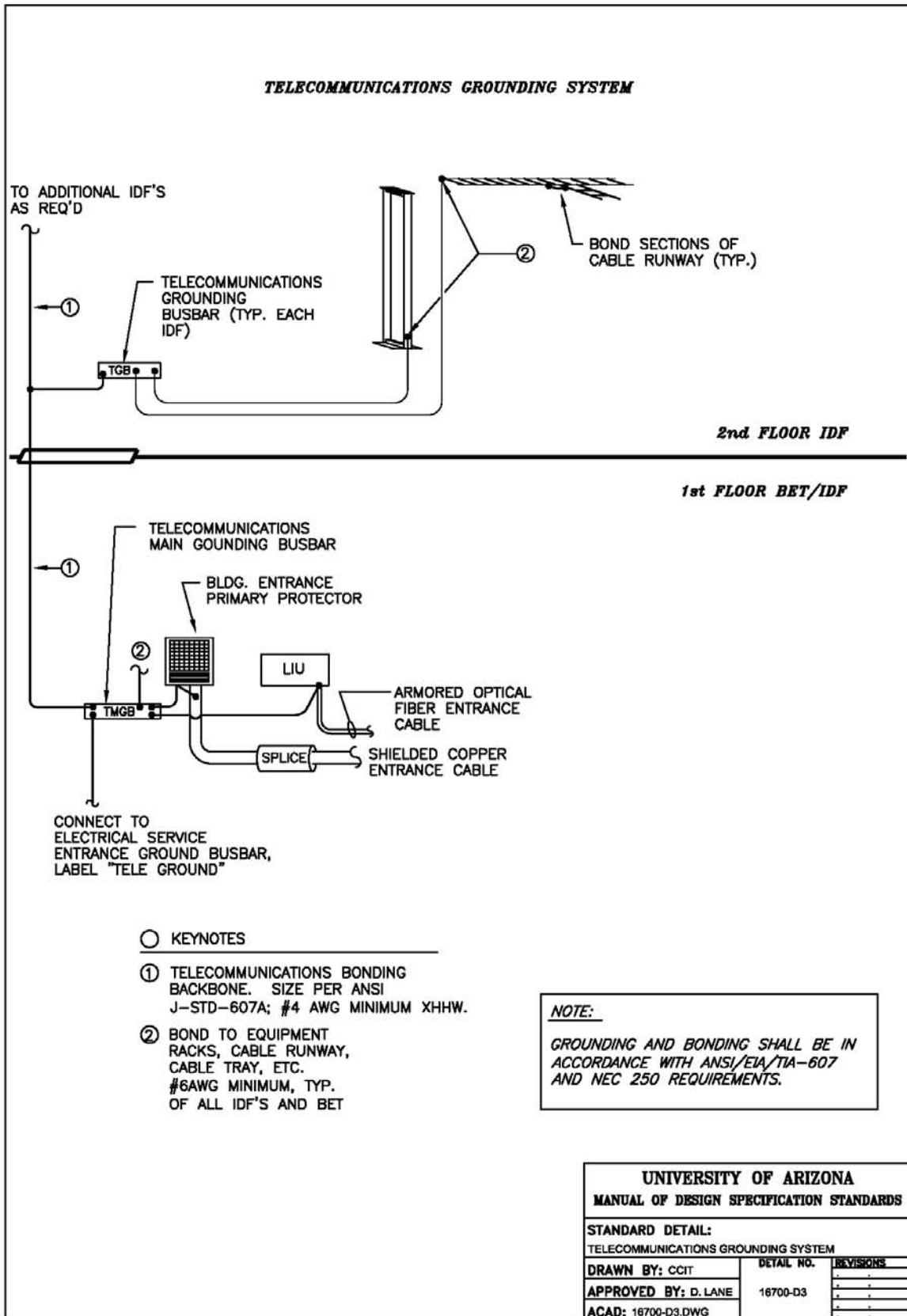



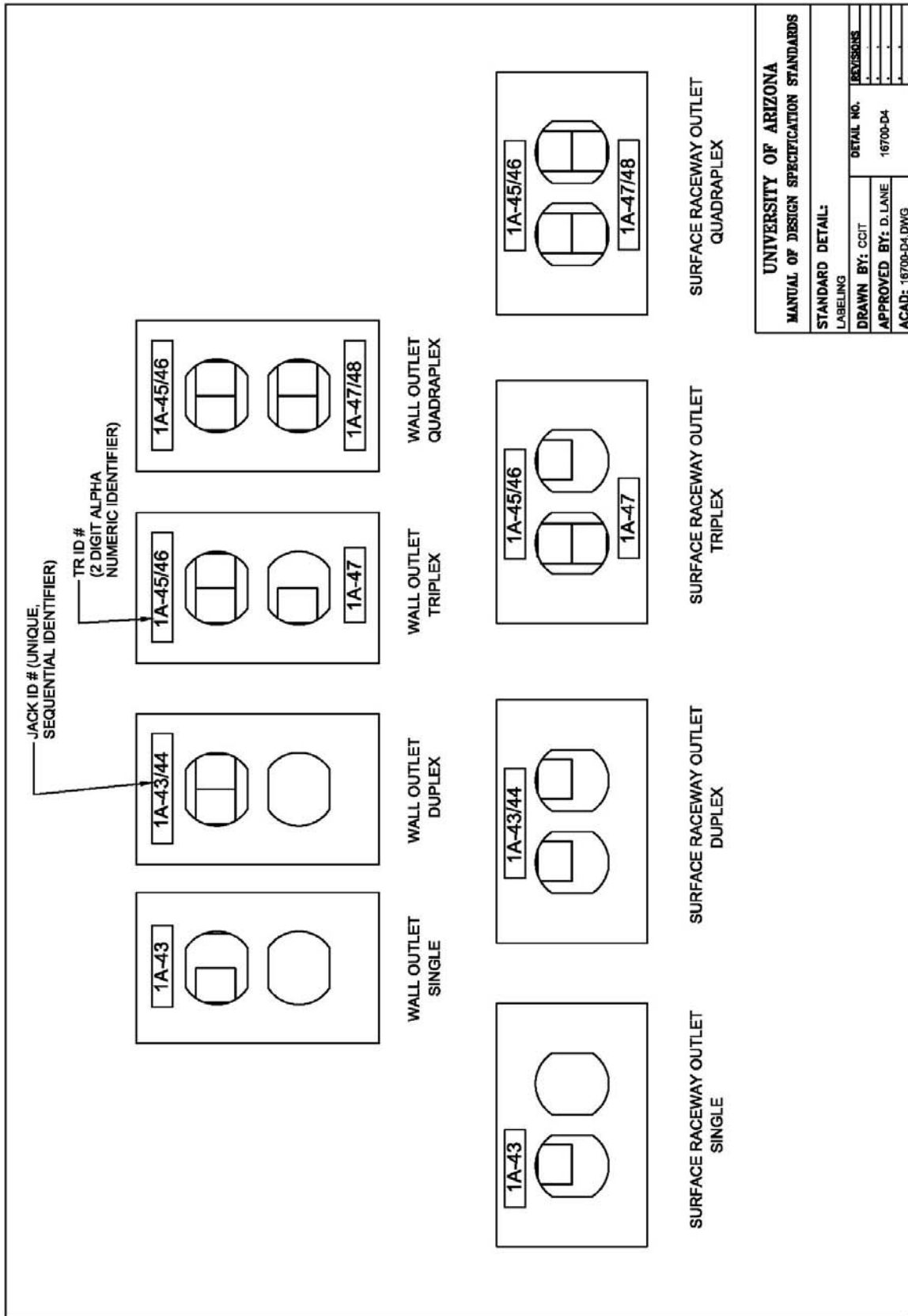

<b>UNIVERSITY OF ARIZONA</b>	
<b>MANUAL OF DESIGN SPECIFICATION STANDARDS</b>	
STANDARD DETAIL:	
LABELING	REVISIONS
DRAWN BY: CCIT	DETAIL NO. 16700-D4
APPROVED BY: D.LANE	16700-D4
ACAD: 16700-D4.DWG	

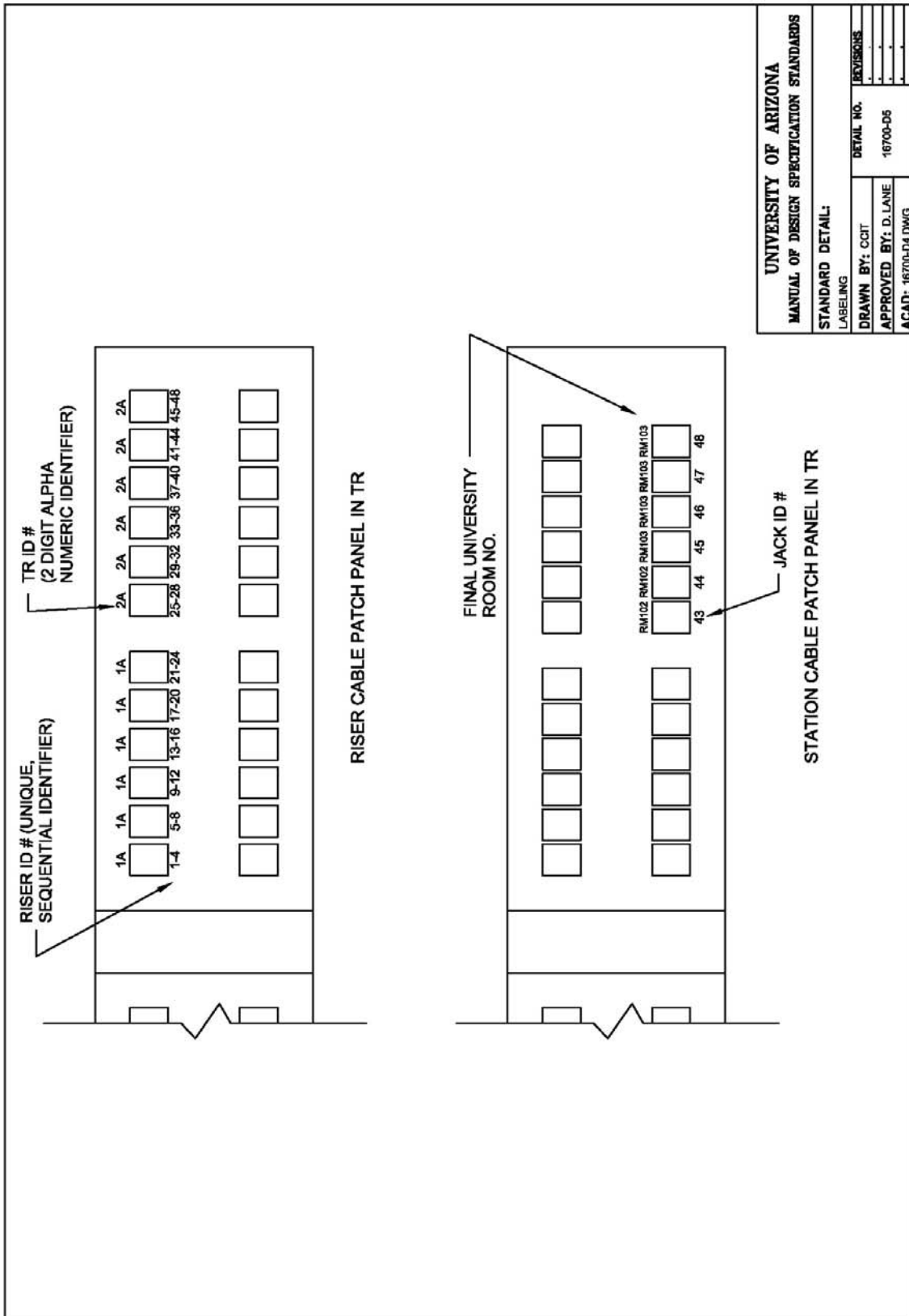

End of Section 16700

## **DIVISION 16 - ELECTRICAL**

### **Section 16705 – Blue Light Phones**

#### **Introduction**

Auxiliary Systems and Communications related support systems.

#### **Part 1 - General**

- This section must be incorporated into each project and coordinated with related sections. These areas include:
  - “Blue Light” emergency phones
  - Telecommunications grounding
- In projects where “Blue Light” emergency phones are required, the installation of the emergency phone unit and mounting pole or wall-mount housing shall be included in the scope of work. Conduit and power shall also be provided for each emergency phone. Electrical outlet shall be installed inside pole for proper disconnect requirements.

#### **Part 2 - Products**

- The following are the part numbers for the Blue Light Phones commonly used at the University of Arizona (include verbal descriptions and verify catalog numbers, require submittals):

Hands-Free Emergency Phone: Talk-a-Phone #ETP-400

Mounting Tower (pedestal): Talk-a-Phone #ETP-MT

Wall-mount Enclosure: Talk-a-Phone #ETP-WM

Authorized Product:

TALK-A-PHONE Co.  
5013 North Kedzie Avenue  
Chicago, Illinois 60625-4988  
Phone: (773) 539-1100  
Fax: (773) 539-1241  
Email: [info@talkaphone.com](mailto:info@talkaphone.com) <http://www.talkaphone.com>

#### **Part 3 – Emergency “Blue Light” Phone Systems**

- Blue phones shall be mounted on steel pedestals with concrete bases, or in wall-mount enclosures as directed by the project manager with #6 ground ring.
- Instruments shall be “Talk-A-Phone Co.”, Model ETP-400, with blue light mounted above. Refer to University Standard details.
- “Blue Light” phones shall be cabled and terminated at the closet IDF closet. Provide station protectors at the phone unit where required by NEC 800.30. Final cross-connections and phone programming will be provided by U of A, CCIT-Telecommunications.

Consultant to coordinate locations with University Risk Management department.

- Refer to Drawings 16705-D1 and 16705-D2.

### BLUE LIGHT PHONE PEDESTAL DETAIL

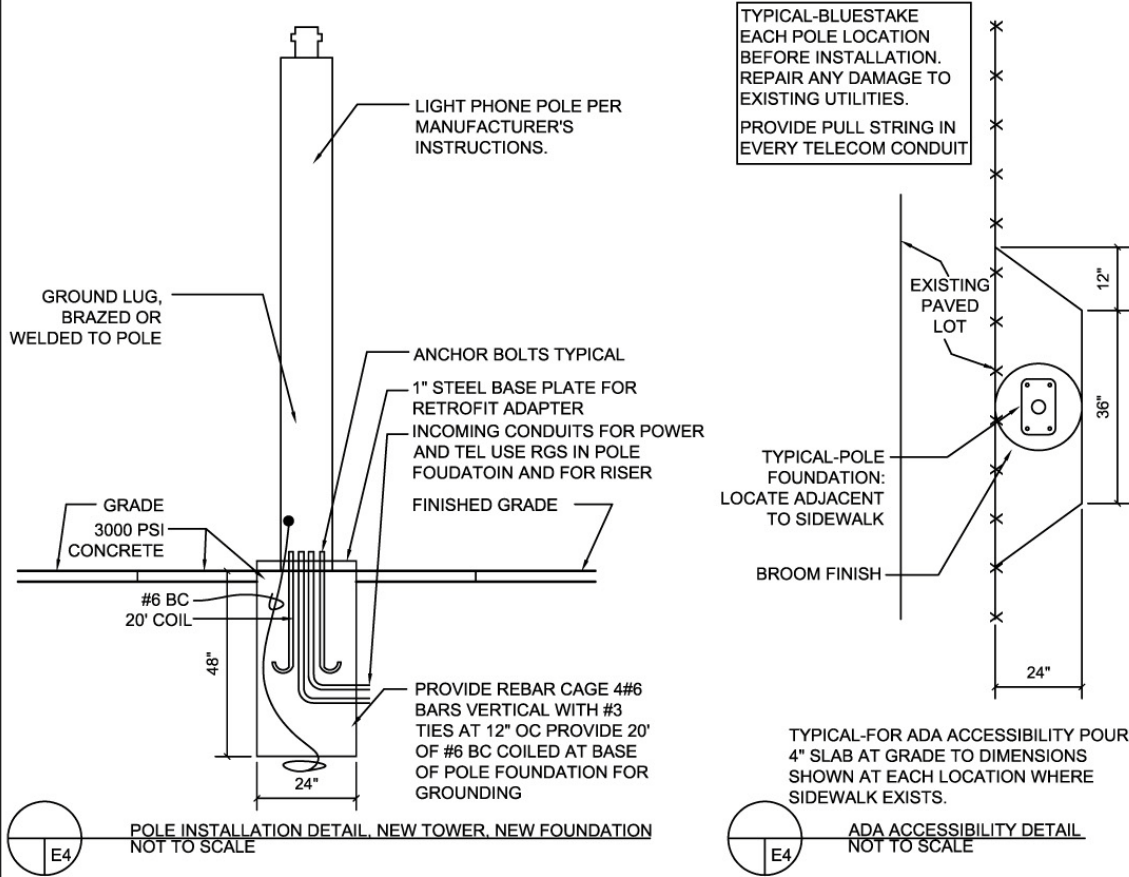

<b>UNIVERSITY OF ARIZONA</b>		
<b>MANUAL OF DESIGN SPECIFICATION STANDARDS</b>		
<b>STANDARD DETAIL:</b>		
<b>BLUE LIGHT PHONE PEDESTAL DETAIL</b>		
<b>DRAWN BY: KML</b>	<b>DETAIL NO.</b>	<b>REVISIONS</b>
<b>APPROVED BY: FD&amp;C</b>	16705-D1	.
<b>ACAD: 16705-D1</b>		.
		.
		.

## BLUE LIGHT PHONE WALL-MOUNT ENCLOSURE

CONTRACTOR SHALL VERIFY WITH EQUIPMENT REQUIREMENTS PRIOR  
TO BUILDING A SYSTEM.

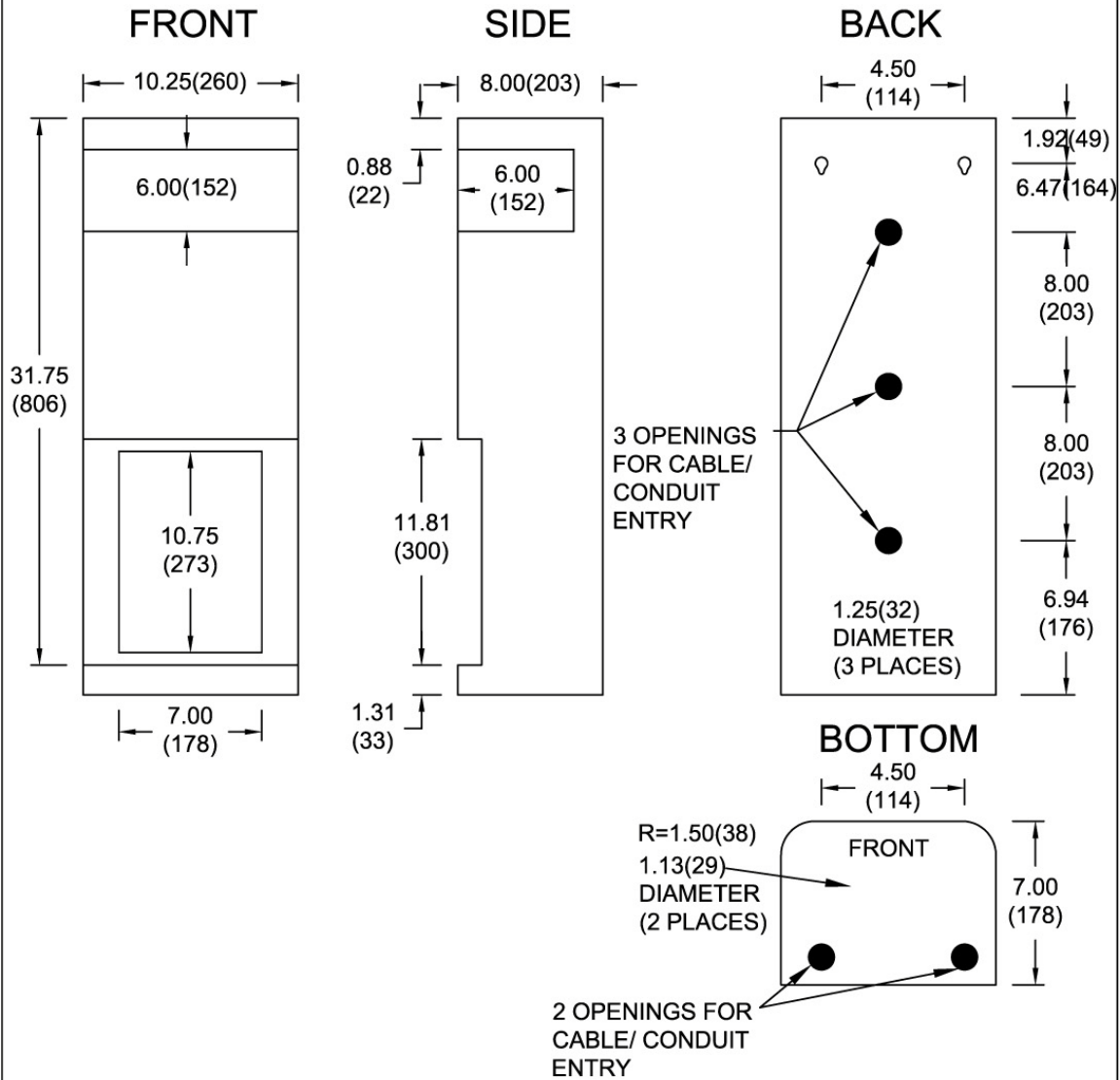

MEASUREMENTS ARE IN(MM),  
TOLERANCE = ± 0.01 IN

<b>UNIVERSITY OF ARIZONA</b>		
<b>MANUAL OF DESIGN SPECIFICATION STANDARDS</b>		
<b>STANDARD DETAIL:</b>		
<b>BLUE LIGHT PHONE WALL-MOUNT ENCLOSURE</b>		
DRAWN BY: KML	DETAIL NO.	REVISIONS
APPROVED BY: FD&C	16705-D2	.
ACAD: 16705-D2		.

End of Section 16705

## **DIVISION 16 - ELECTRICAL**

### **Section 16720 - Fire Alarm Systems**

#### **Introduction**

The fire alarm systems here at the University are integrated together into a single reporting system which reports to the U of A police department. To maintain system integrity it has been decided that all systems shall be manufactured by Simplex and shall be compatible with the 4120 addressable multiplexed system as manufactured by Simplex. To maintain and insure system integrity with new projects, the University has developed a guide form specification, which must be edited by the engineer in charge of each particular project. Each fire alarm system specification must be evaluated on an item by item basis and the specification edited to be project specific. For example some projects by the nature of the type of building and its occupancy will be required to have a voice evacuation signal. For most projects the standard horns and strobes *no longer* will suffice. Smaller projects will not require the complexity of the design that the larger ones will require, and thus some of the specification may be deleted.

For new projects it will be necessary to connect the system back into the central reporting system loop. This loop is composed of a series of cables routed through the existing tunnel network. During the preliminary design it will be necessary for the engineer to discuss with the University Fire Safety representative as to the exact location of the point of connection to this loop.

For existing buildings the system interconnection should be intact, and it will be necessary only to tie the new system into the existing loop at the point of connection.

Where only a few devices are required it will be necessary for the engineer to delete all non applicable portions of the guide form specification and make it project specific.

Typically the fire alarm systems are to be considered a higher quality system than what is normally used in a facility of this type. All new systems are to be fully addressable systems with horns and strobes throughout and in compliance with ADA and NFPA requirements. Smoke detectors are to be used in all corridors, with duct smoke detectors on all AHU's over 2000 cfm per the Uniform Mechanical Code. All conference rooms and classrooms are to have alarm indicators, with A/V's to be used in larger lecture halls. Strobes are to be used in all restrooms. Pull stations are to be used at all exits from a floor on multistory buildings and at any and all building exits. In addition provide pull stations where required by the NFPA 72. All mechanical rooms shall be protected using heat detectors. All electrical rooms, telecommunications rooms, storerooms, and janitor closets shall be protected using smoke detectors.

Elevators shall have shunt trip detectors installed whenever a sprinkler head is located in the shaft or equipment room. To activate the shunt trip system a heat detector must be installed within 18" of each sprinkler head, and must be coordinated with the sprinkler head such that the heat detector will operate at a lower temperature than the sprinkler head. The heat detectors will notify the system of a problem, which will activate the shunt trip detector through a ZAM module. Elevator recall shall be activated through smoke detectors located at each floor or at the top of the shaft. It may be necessary based on state elevator codes to have both items, side by side, in a shaft. Where the elevator recall function is not available all equipment and programming for a future modification to the elevator shall be provided.

Utilize Class A wiring to all devices on the system. Color codes shall be in accordance with University standards. All conduits shall run concealed unless no other option is available. Conduit, wiring, j-boxes, etc. shall be installed in compliance with other areas of this standard. Conduits shall have a minimum separation of 6'. This is the University's decision and standards requirement.

All fire alarm systems designed and installed throughout the University shall be capable of being expanded easily and readily. In order to make this easier we would like to require that both alarm and mapnet loops have at least 30% spare capacity.

For all new projects it has been decided that the University will require the new system to be up and fully operational for a minimum of 5 days prior to having the fire marshal do his final inspection. At the point in time that the contractor believes that the system is ready to begin the 5 day "burn in" the supplier will certify to the owner that the system is fully operational. Until receipt of this letter the acceptance test will not be considered to have begun. During the acceptance test no modifications to the system can be made. The contractor may be permitted to remove or demolish the existing system where applicable and where permitted by the owner prior to acceptance of the new system by the owner.

### **Part 1 - General**

- Provide in accordance with the standards set forth in the guide form specification and instructions from the FDC Electrical Engineer during the pre-design conference.
- *Design shall confirm to NFPA 72, the requirements of the State Fire Marshal and the Uniform Fire Code.*
- *The consultant shall complete comprehensive plans, and single line diagrams based on the system described in the App-16720 Section of this DSS.*
- *The consultant shall perform voltage drop calculations as part of the Construction Document Submittal for looped signal circuiting. Signal circuits shall not exceed 70% loading in order to accommodate future system changes.*
- *Provide heat detectors in elevator shafts, machine rooms. Set 20°F lower than sprinkler heads, to signal the FACP to shut down the elevators.*
- *The consultant shall show the following supervisory functions on plans and single line diagrams. All conductors shall be in metal conduit.*
- *Phone circuit from FACP, with jack, to telephone terminal board.*
- *Monitoring circuit from each elevator control monitoring circuit (in machine rooms) to the FACP.*
- *Monitoring circuit from Engine Generator to the FACP, to monitor generator running.*
- *Circuit from switchboard meter to FACP.*
- *The consultant shall provide emergency lighting in the vicinity of the FACP.*
- *Generally speaking, graphic annunciation is not utilized.*

### **Part 2 - Products**

- Provide in accordance with the standards set for the in the guide form specification Section 16720, as discussed in the introduction to this section, *and as directed.*
- Where pull stations are susceptible to nuisance vandal pulling, a protective local alarm type covering device shall be provided.

### **Part 3 - Execution**

- Provide in accordance with the standards set for the in the guide form specification Section 16720 and as discussed in the introduction to this section.
- Wiring color codes shall be as specified in division 16195. J-boxes shall be identified as per division 16195.
- Testing. Insert the following language at this Section:
  - "The fire alarm system shall be 100% complete, operational and free from trouble or alarm conditions prior

to testing by the Owner. After the Owner has tested and verified operation of the fire alarm system the system shall go through a 5 day burn in time, during which the system shall operate under normal conditions with no modifications by the contractor. At the end of this period the fire alarm system shall be tested and approved by the State Fire Marshall who shall issue a letter of acceptance. Only upon receipt of approval by the Fire Marshall shall this system be considered complete.”

**End of Section 16720**



## **DIVISION 16 - ELECTRICAL**

### **Section 16730 - Clock and Program Systems**

#### **Introduction**

Clock systems shall be provided for all new buildings. The University has a master clock system which receives a signal from the National time standard located in Colorado. All campus clocks are synchronized to this signal from the master clock. Therefore it is imperative that the specification and drawings include requirements for connecting the new buildings to the plant distribution system.

Signal systems shall be provided for all new classroom type buildings and construction. The signal system shall be programmable through the building master clock system.

Bell system wiring shall be run with the clock system.

Each new or renovated system shall incorporate a building submaster clock to isolate each building in case of a fault on the main campus master clock.

#### **Part 1 - General**

- Provide complete submittals on all new clock systems including complete maintenance and operation manuals for each new system installed.

#### **Part 2 - Products**

- Compatible with the present Master time system which is manufactured by Simplex Time Recorder Company.
- Any substitute must prove that it is compatible with this system.
- The existing system is a 24 vdc impulse system with a 24 vdc 3 wire correction. All clocks should be semiflush mounted. Each clock shall have an integral two lobe 5 minute catch up cam.
- Wiring color code should be in accordance with section 16195.

#### **Part 3 - Execution**

- For rearrangement type projects final tie-in of clocks to building system will be by the University Facilities Management Electric Shop.
- Final tie in of new building systems with the campus systems will be by the University Facilities Management Electric Shop.
- Testing for new facilities shall be done with factory trained representative of the manufacturer, the U of A Electric Shop, and the Engineer.

#### **End of Section 16730**

## **DIVISION 16 - ELECTRICAL**

### **Section 16950 - Testing**

#### **Introduction**

Testing for all areas shall be listed under this section and referenced back to the appropriate Section.

Testing shall be done in accordance with NETA standards.

#### **Part 1 - General**

- Written documentation shall be provided to the U of A electrical engineer for all testing accomplished under this section.
- Although NETA test standards are referenced herein for brevity it is required that the engineering firm, rewrite the test standards for application to the specific project.
- All the required testing shall be fully spelled out in the specifications.
- Cable shall be 5kv megger tested on their respective reels.
- Cable shall be high potential tested with terminations in place after assembly.

#### **Part 2 - Products**

- A partial list of equipment to be tested shall include:
  - wire and cables
  - high voltage switchgear
  - transformers
  - panelboards
  - switchboards
  - emergency generator
  - ups type systems.
  - 50 Hp and larger motors - absorption - polarization index
- Testing of medium voltage cables (5KV or 15KV), transformers, and switchgear shall be by a third party testing firm which has all of the equipment and capabilities for performing the specified tests.
- All other testing shall be accomplished by the electrical contractor doing the work.

#### **Part 3 - Execution**

- All medium voltage rated cable shall be tested in accordance with NETA testing standards.
- Medium voltage transformers, cable, and switchgear shall be tested in accordance with NETA testing standards, with a complete written report provided to the U of A prior to completion of the project. All testing of this equipment shall be accomplished in the presence of the Engineer or a representative of the University Facilities Management Electric Shop.
- For actual requirements of each area, verify testing requirements with the Engineer.
- All wire and cable utilized on the 120/208 and 480/277 volt systems shall be megger tested utilizing a 1000 volt rated tester.

- All panelboards and switchboards shall be meggar tested prior to energizing.
- All connections inside of switchboards, panelboards, motor control centers, and similar equipment shall be torqued and tested prior to energizing the equipment.

**End of Section 16950**

**Section 16122 PRIMARY POWER CABLES**

**PART 1 GENERAL:**

- WORK INCLUDED

The Contractor shall furnish and install all shielded power cable suitable for use on this project.

- RELATED WORK

Section 16020: Tests

- SUBMITTALS

The Contractor shall submit test and product data in accordance with Section OI 300.

**PART 2 PRODUCTS:**

Acceptable Manufacturer: Okonite or Kerite meeting these specifications is acceptable.

- TYPE AND RATING

The cable shall be certified for normal operation at a conductor temperature of 105 degrees C; in wet and dry locations; in conduit above and below ground; in exposed cable tray runs. Conductors shall also be certified for operation at 1 30°C during emergency conditions and 250°C under short circuit conditions. The cable insulating and jacketing materials shall have a forty year average service life.

All cable shall have the voltage ratings as hereinafter specified with ethylene propylene rubber insulation and suitably sized copper conductors. The cable shall be supplied in the quantities and number of conductors specified and for the functions as listed.

- SHIELDED POWER CABLE

Cable Type and Size	Voltage Rating
Copper Conductors Copper Foil Shield	15 kV - 133% Insulation

- QUALITY ASSURANCE

Each power cable shall be given the manufacturer's standard production tests to assure that all cables adequately meet the requirements of these specifications. All cable shall conform to the applicable requirements of ICEA Publication S-68-516, UL 1072, Federal Standard 10 CFR 50, and UL Type MV 105 EPR and the latest specifications for extruded insulation. The copper conductors shall conform to ASTM-B8 for annealed copper, Class B stranded, compressed concentric round.

Test data shall be furnished to the Owner. Test data may apply to the cables being furnished under this purchase order, or may be certified results of tests previously made on identical cables.

Materials used in the manufacture of the cable covered by these specifications shall be of the kind, composition and physical properties best adapted to their various purposes and conform to the standards of AEIC, ANSI, ASTM, IEEE, ICEA, NEC, NEMA and UL in effect on the date of the bid-opening as to material, workmanship, design and testing. Tolerances and practices in manufacture of finished cable shall conform to the best modern shop practices.

- **SPECIFIC SUBMITTAL REQUIREMENTS**

**Materials Test Reports:** Where specific materials tests are herein specified or where such tests are required by specific standard governing the manufacture of such materials, six (6) copies of certified test results shall be furnished by the manufacturer to the Contractor who shall submit them to the Owner.

The Contractor shall submit certified copies of the results of all standard production tests and tests performed in accordance with NEMA, and ICEA S-66-524 Standards as required by paragraph above, "Quality Assurance".

**Technical Data:** Contractor shall submit within 30 calendar days after receipt of Notice of Award values for all technical data regarding the cable being furnished.

- **DESIGN AND CONSTRUCTION**

**Conductors:** All copper conductors shall be stranded, and fabricated from uncoated, annealed copper wire conforming to ASTM B8. Stranding shall be concentric lay Class B, Standard, #2 cable.

**Insulation:** Conductors shall be insulated with ethylene propylene flexible thermosetting dielectric compound. The ethylene content of the compound shall not exceed 72% by weight of ethylene nor shall the compound contain any polyethylene. The insulation shall be triple-tandem extruded with the conductor and insulation screens. The extruded screen shall be free stripping. The outer screen/insulated core shall be covered with an uncoated copper tape. It shall be applied helically with 12.5% nominal overlap. The overall jacket shall be polyvinyl chloride.

**Semi-Conductor Screens:** These shall be Ethylpropylene based.

**Identification:** All cable shall have a permanent and readily identifiable exterior surface marking at appropriate intervals along its entire length. The method of marking shall be subject to the approval of the Owner. The marking shall contain the following information:

- Manufacturer
- Year of manufacture
- Size and type of conductor
- Rated voltage
- Insulation thickness
- Shield
- Type of jacket

**Reels:** All cable shall be furnished on reels. Each reel shall have the diameter of the drum large enough to prevent damage to the cable from reeling. The maximum flange diameter of the reel is not to exceed 78 inches. The outer end of the cable shall be securely fastened to the reel head so as to prevent the cable from becoming loose in transit. The inner end of the cable shall project into a slit in the side of the reel or into a housing on the inner side of the drum in such a way as to

**DIVISION 16 ELECTRICAL****PROJECT NO.**

make it available, if required, for test. The inner end shall be fastened to prevent it from becoming loose during installation. Each reel shall be plainly marked to indicate the direction in which it should be rolled to prevent loosening of the cable on the reel. The reels shall be lagged. Each length of cable shall be effectively sealed to prevent the entrance of moisture. The seal shall be applied in such a way as to prevent damage to the conductors or cable.

- **DATE OF MANUFACTURE**

All cable utilized in a pull shall have been manufactured during the same production run from the factory. All cable shall be new and shall have been manufactured within 3 months of the date of receipt at the job site. Storage of cable prior to installation shall comply with the recommendations of the manufacturer.

- **GUARANTEE**

The manufacturer of the cable shall furnish medium voltage cable which shall comply with the following warranty:

"The manufacturer shall warrant the cable to free from defects in material and workmanship for the 40 year design life of the cable; provided the cable is employed under the conditions contemplated and covered by the design specifications, and provided further that the cable is installed, spliced, terminated, maintained, and operated in accordance with the manufacturer's recommended procedures, at the time of bid."

In the event that the cable is defective in manufacture, as determined by the manufacturer and the University of Arizona jointly, the manufacturer's only responsibility will be to supply another cable for the defective portion, the new cable to be delivered free of charge to the University of Arizona.

Manufacturer shall not be responsible for any defects or repairs to, or replacement of, adjacent or connected equipment to which the cable may supply electric power or from which it may take electrical power or from which it may take electrical power. Manufacturer will not be responsible for any termination, maintenance, or operation which is not in accordance with the manufacturer's recommended standards and procedures."

**PART 3 EXECUTION:**

- **INSTALLATION**

Reels shall be rolled only in the direction indicated by the manufacturer and no reel containing cable shall be dropped from a truck or from any other comparable height, under any circumstances. In turning reels, particularly after the lagging has been removed, bars shall be used in such a manner that they will not bear against the cable. Reels shall not be rolled over rocks or other projecting objects which are liable to damage the cable and, when it is necessary to roll unlagged reels over soft ground, plant tracks shall be provided to keep the reel from sinking with possible damage to the cable. Cable shall be carefully handled during installation and shall be unreeled or uncoiled slowly to prevent damage to the insulation or sheath from sudden bending. The ends of any cable used shall be kept sealed from moisture at all times, either for cables that have been pulled and are awaiting connection, or for cables on reels in storage. In no case shall cables be allowed to lie on the floor or any other location where they may be subject to damage. If necessary, temporary supports shall be provided and arranged so as not to interfere with any provisions for permanent supports, or require any cable splicing. When reeling the cable

off of the reels and pulling it into the conduit every effort must be made to protect the cable from damage. The cable shall not be pulled off onto bare ground, asphalt, or concrete. Wherever it is required to pull cable off of the reel for a subpull it shall be necessary for the contractor to provide a surface which will not subject the cable to abrasion during the subpull.

Sharp kinks shall be avoided in any unreeling, uncoiling, and pulling operation, and the cable shall be carefully guided and trained into conduits or other raceways in as direct a manner as possible with a minimum amount of bending. The Contractor shall be responsible for keeping any cable bends to as large a radius as feasible and, where practicable, the minimum radius shall be kept at a value no less than 12 times the outer diameter of the insulation or covering. Where conditions dictate the installation, necessary bends of a small radius will be permitted, subject to the approval of THE UNIVERSITY OF ARIZONA. Any cable pulled in a manner resulting in damage to the shielding shall be removed and replaced at the direction of THE UNIVERSITY OF ARIZONA and at the Contractor's expense. Following the installation of the cable and until such time as the splice or stress cone is made the cable shall be resealed to prevent absorption of moisture into the insulation of the cable.

Before any cable is pulled in any conduit, such conduit shall have been tested for and cleared of, any obstruction in accordance with the requirements of Section 16115. The conduit termination shall be provided with a bushing or other suitable protector to guard against damage to the insulation or outside covering. Cable may be pulled by woven basket wire grips or by attachment of the pulling device directly to the conductor. Pulling tension shall not exceed the manufacturer's recommended limits. Soapstone, or other non-hardening pulling lubricant, approved by THE UNIVERSITY OF ARIZONA electrical engineer for the type of insulation involved, shall be used to help facilitate pulling requirements. All cable installed shall be arranged, and tied where necessary, in the opinion of THE UNIVERSITY OF ARIZONA, in a neat and orderly manner. Cable shall enter and leave in neat packs and shall be arranged in such a way as not to block openings or future use. The cables shall be supported clear of sharp edges or any structural framework. Cables shall be kept clear of any obstruction while placing. Cable installation procedures shall be reviewed by the U of A electrical engineer and shall be subject to the approval of the Owner.

Splices will not be permitted except where indicated on the drawings or where specifically approved by the engineer prior to start of work for high voltage cable. The Contractor shall furnish all materials and perform all work required for the complete termination or splicing of any wire, or cable including any stress cones that may be required. Terminations, splices and stress cones for high voltage cables and conductors shall be completed in accordance with manufacturer's recommendations or as directed by THE UNIVERSITY OF ARIZONA.

All high voltage cable splicing and dressing work shall be performed by men and crews thoroughly experienced (minimum five years) in such work, and each such cable splicer shall be approved by THE UNIVERSITY OF ARIZONA before splicing has begun. High voltage cable shall be given a high potential test per the requirements of section 16950 before final termination. Where desirable, the final termination taping shall be extended over the terminal connector onto the bus or bushing of the equipment to which the conductor is attached. Final taping shall generally be applied from bottom to top to provide the best possible shield and, in wet or damp locations, terminal taping shall be painted with insulating varnish. The Contractor may use premolded slip on type splices, taps and stress-cones. These premolded devices shall be made of ethylene propylene terpolymers. All cable splices shall be approved for use by the cable manufacturer on the specific cables.

**DIVISION 16 ELECTRICAL****PROJECT NO.**

Where T connections are approved by the University of Arizona Engineer, utilize bushars with load break elbow terminals and bushings. Use deadfront devices when they are available.

**PART 4 PHASING AND IDENTIFICATION:**

The contractor shall verify the existing phasing on all equipment being reconnected to a new service prior to removing the equipment and shall reconnect the equipment back to match original phasing following the completion of the installation of the new service.

**End of Appendix Section 16122**



**Section 16310 - PRIMARY SWITCH STATION**

**PART 1 GENERAL**

1.01 Description of Work

- A. The pad-mounted gear shall be in accordance with the one-line diagram, and shall conform to the following specification. This gear shall be type PMH-11 or PMH-9 as determined by consultation with the University of Arizona Electrical Engineer. It shall be as manufactured by S&C Corporation or prior approved equal.
- B. The pad-mounted gear shall consist of a single self-supporting enclosure, containing interrupter switches and power fuses with the necessary accessory components, all completely factory-assembled and operationally checked.
- C. NOTE: It is the intent of the University to use equipment rated for 13.8 KV ungrounded systems on 4160 volt at this time to allow for conversion to 13.8 KV ungrounded systems in the future.

1.02 Ratings

- A. The ratings for the integrated pad-mounted gear shall be as designated below:

KV, Nominal 14.4	
KV, Maximum Design	17.0
KV, BIL	95
Main Bus Continuous, Amperes	600
Three Pole Interrupter Switches	
Continuous, Amperes (Source/Feeder)	600/600
Live Switching, Amperes (Source/Feeder)	600/600
Two-Time Duty-Cycle Fault-Closing	
Capability, Amperes Rms Asymmetrical	22,400
Fuses with Integral Load Interrupter	
Maximum, Amperes	200
Live Switching, Amperes	200
Two-Timing Duty-Cycle Fault-Closing	
Capability, Amperes Rms Asymmetrical	13,000
Short-Circuit Ratings	
Amperes, Rms Symmetrical at	12,500
Mva Three-Phase Symmetrical at	
Rated Nominal Voltage	310

- B. The momentary and two time duty cycle fault closing ratings of switches and bus, interrupting ratings of fuses, and one-time duty-cycle fault-closing capabilities of the fuses with integral load interrupters shall equal or exceed the short-circuit ratings of the pad-mounted gear.

1.03 Certification of Ratings

- A. The manufacturer shall be completely and solely responsible for the performance of the basic switch and fuse components as well as the complete integrated pad-mounted gear assembly as rated.
- B. The manufacturer shall furnish with the bid certification of ratings of the basic switch and fuse components and the integrated pad-mounted gear assembly consisting of the switch and fuse components in combination with the enclosure.

## 1.04 Compliance with Standard and Codes

- A. The pad-mounted gear shall conform to or exceed the applicable requirements of the following standards and codes:
  - 1. Applicable safety and health standards promulgated pursuant to Federal Occupational Safety and Health Act of 1970 which are in effect 30 days prior to the date of quotation or bid.
  - 2. Article 710-21(e) Circuit Interrupting Devices (Load Interrupters) in the 1984 National Electrical Code, which specifies that the interrupter switches in combination with power fuses shall safely withstand the effects of closing, carrying, and interrupting all possible currents up to the assigned maximum short-circuit rating.
  - 3. All portions of ANSI, IEEE, and NEMA standards applicable to the basic switch and fuse components.

## 1.05 Enclosure Design

- A. To ensure a completely coordinated design, the pad-mounted gear assembly shall be constructed in accordance with the minimum construction specifications of the fuse and/or switch manufacturer to provide adequate electrical clearances and adequate space for fuse handling.
- B. In establishing the requirements for the enclosure design, consideration shall be given to all relevant factors such as controlled access and tamper resistance. Provide padlock and penta head fasteners, in addition to manufacturer's normal controls.

**PART II PRODUCTS AND EXECUTION**

## 2.01 Insulators

- A. The interrupter-switch and fuse-mounting insulators shall be of a cycloaliphatic epoxy resin system with characteristics and restrictions as follows:
  - 1. Operating experience of at least 10 years under similar conditions.
  - 2. Ablative action to ensure nontracking properties.
  - 3. Adequate leakage distance established by test per IEC Publication 507, First Edition, 1975.
  - 4. Adequate strength for short-circuit stress established by test.
  - 5. Conformance with applicable ANSI standards.
  - 6. Homogeneity of the cycloaliphatic epoxy resin throughout each insulator to provide maximum resistance to power arcs. Ablation due to high temperatures from power arcs shall continuously expose more material of the same composition and properties so that no change in mechanical or electrical characteristics takes place because of arc-induced ablation. Furthermore, any surface damage to insulators during installation or maintenance of the pad-mounted gear shall expose material of the same composition and properties so that insulators with minor surface damage need not be replaced.

## 2.02 High-Voltage Bus

- A. Bus and interconnections shall consist of copper bar.
- B. Bus and interconnections shall withstand the stresses associated with short circuits up through the maximum rating of the pad-mounted gear, including proper allowance for transient conditions.
- C. All current carrying parts shall be copper or bronze.

## 2.03 Ground-Connection Pads

- A. A ground-connection pad shall be provided in each compartment of the padmounted gear.
- B. The ground-connection pad shall be constructed of steel, 3/8" thick for use with 600 ampere main bus which shall be copper clad and welded to the enclosure, and shall have a short-circuit rating equal to that of the integrated assembly.
- C. Ground-connection pads shall be coated with a uniform coating of an oxide inhibitor and sealant prior to shipment.

## 2.04 Enclosure

- A. The pad-mounted gear enclosure shall be of unitized monocoque (not structural frame-and-bolted-sheet) construction to maximum strength, minimize weight, and inhibit internal corrosion.
- B. The basic material shall be 11-gauge hot-rolled, pickled, and oiled steel sheet.
- C. All structural joints and butt joints shall be welded, and the external seams shall be ground flush and smooth.
  - 1. The gas-shielded short-circuiting transfer welding process shall be employed to eliminate alkaline residues and to minimize distortion and spatter.
  - 2. Any welds made by other than this method shall be ground and sanded (wire brushed if internal) to remove all scale and alkaline residues formed during welding.
- D. To guard against unauthorized or inadvertent entry, enclosure construction shall not utilize any externally accessible hardware.
- E. The base shall consist of continuous 90-degree flanges, turned inward and welded at the corners, for bolting to the concrete pad. The flanges shall be formed from double-thickness folded edges for strength and rigidity, with the sheared edges folded back into the inside of the enclosure to minimize exposure to corrosive attack.
- F. The door openings shall have 90-degree flanges, facing outward, that shall provide strength and rigidity as well as deep overlapping between doors and door openings to guard against water entry.
- G. Roof edges shall be formed to create a mechanical maze with the top flanges of the enclosure which shall allow free-flow ventilation to help keep the enclosure interior dry while discouraging tampering or insertion of foreign objects.
- H. A heavy coat of insulating "no-drip" compound shall be applied to the inside surface of the roof to prevent condensation of moisture thereon.
- I. Insulating interphase and end barriers of fiberglass-reinforced polyester shall be provided for each interrupter switch and each set of power fuses where required to achieve BIL ratings. Additional insulating barriers of the same material shall separate the front compartments from the rear compartments and isolate the tie bus (where furnished).
- J. Models containing source switches rated 600 amperes continuous shall have full-length steel barriers separating adjoining compartments.
- K. Lifting tabs shall be removable. Sockets for the lifting tab bolts shall be blind-tapped. A resilient material shall be placed between the lifting tabs and the enclosure to prevent the tabs from scratching the enclosure finish. To help retard corrosion, this material shall be closed-cell neoprene to prevent moisture from being absorbed and held between the tabs and the enclosure.

- L. Interrupter switches shall be provided with dual-purpose front barriers. These barriers, in their normal hanging positions, shall guard against inadvertent contact with live parts. It shall also be possible to lift these barriers out and insert them into the open gap when the switch is open. A window panel shall be provided to allow viewing of the switch position without removing the barriers. These barriers shall meet the requirements of Section 381 .G of the National Electrical Safety Code (ANSI Standard C2).
- M. Each fuse shall be provided with a dual-purpose front barrier. These barriers, in their normal hanging positions, shall guard against inadvertent contact with live parts. It shall also be possible to lift these barriers out and insert them into the open gaps when the fuses are in the disconnect position. These barriers shall meet the requirements of Section 381.G of the National Electrical Safety Code (ANSI Standard C2).
- N. A (steel-compartmented) base spacer shall be provided to increase the elevation of live parts in the pad-mounted gear above the mounting pad by 24 inches.

#### 2.05 Doors

- A. Doors shall be constructed of 11 gauge hot-rolled, pickled, and oiled steel sheet.
- B. Door-edge flanges shall overlap with door-opening flanges and shall be formed to create a mechanical maze that shall guard against water entry and discourage tampering or insertion of foreign objects, but shall allow free-flow ventilation to help keep the enclosure interior dry.
- C. Doors shall have a minimum of three stainless steel hinges and hinge pins. The hinge pins shall be welded in place to guard against tampering.
- D. In consideration of controlled access and tamper resistance, each door (or set of double doors) shall be equipped with a positive-action three-point latching system.
- E. Each door (or set of double doors) shall be provided with a recessed stainless steel door handle. The door handle shall be padlockable and shall incorporate a hood to protect the padlock shackle from tampering. The handle shall be provided with a recessed penta head bolt for additional security.
- F. Doors providing access to solid-material expulsion-type power fuses shall have provisions to store spare refill units.
- G. Each door shall be provided with a galvanized-steel door holder located above the door opening. These holders shall be hidden from view when the door is closed, and it shall not be possible for the holders to swing inside the enclosure.
- H. Doors shall automatically self lock open.

#### 2.06 Ventilation System

- A. Ventilation system shall be provided along the bottom and top at each side of the enclosure.
- B. Each vent shall have an inside baffle to protect against insertion of foreign objects, or shall be so constructed as to prevent insertion of foreign objects.

#### 2.07 Finish

- A. During fabrication, the areas of structural parts which may later become inaccessible, such as folded edges and overlapping members, shall be given a phosphatizing bath and an iron-oxide zinc-chromate anti-corrosion primer to ensure that all surfaces are protected.

- B. Any welds made by other than the gas-shielded short-circuiting transfer welding process shall be ground and sanded (wire brushed if internal) to remove all scale and alkaline residues formed during welding.
- C. Full coverage at joints and blind areas shall be achieved by processing enclosures independently of components such as doors and roofs before assembly into the utilized structures.
- D. All exterior seams shall be filled and sanded smooth for neat appearance.
- E. To remove oils and dirt, and to form a chemically and anodically neutral conversion coating to improve the finish-to-metal bond, and to retard underfilm propagation of corrosion, all surfaces shall undergo a thorough pretreatment process before any protective coatings are applied.
- F. After pretreatment, protective coatings shall be applied that shall help resist corrosion and protect the steel enclosure. To establish the ability of the finishing system to resist corrosion and protect the enclosure, representative test specimens shall satisfactorily pass the following tests:
  - 1. 1000 hours of exposure to salt-spray testing per ASTM B 11 7-73 with loss of adhesion from bare metal not to extend more than 1/8" and underfilm corrosion not to extend more than 1/32" from the scribe.
  - 2. 1000 hours of humidity testing per ASTM D 2247 with the formation of no more than #6 medium blisters as evaluated per ASTM D 714-56.
  - 3. 500 hours of accelerated weather testing per ASTM G 53-77 with no more than 25% reduction of paint gloss.
  - 4. Crosshatch adhesion testing per ASTM D 3359 Method B with no loss of paint.
  - 5. 160 inch-pound impact adhesion testing per ASTM D 2794-69 with no paint chipping or cracking.
  - 6. Certified test abstracts substantiating such capabilities shall be furnished with the bid.
- G. The finishing system shall be applied without sags or runs for a pleasing appearance.
- H. After the finishing system has been properly applied and cured, welds along the enclosure bottom flange and around the door hinges shall be coated with a wax-based anti-corrosion moisture barrier to give these areas added corrosion resistance. Weld studs within the enclosure that are not covered by nuts shall be coated with an oxide-inhibiting compound to help guard against corrosion starting on the exposed threads.
- I. After the enclosure is completely assembled and the components (switches, fuses, bus, etc.) are installed, the finish shall be inspected for scuffs and scratches. Blemishes shall be carefully touched up by hand to restore the protective integrity of the finish.
- J. The finish shall be sage green. Contractor shall sand finish with #220 grit dual action Sander Prime with duPont Vari Prime #815/8165 and apply 3 wet coats of duPont catalyzed acrylic enamel. Color is Federal Standard 595b, 14449.

## 2.08 Corrosion

- A. To guard against corrosion, all hardware (including door fittings, fasteners, etc.), all operating-mechanism parts, and other parts subject to abrasive action from mechanical motion shall be of either non-ferrous materials, or galvanized, or zinc-plated ferrous materials. Cadmium-plated ferrous parts shall not be used.

## 2.09 Tamper Resistance

- A. In consideration of tamper resistance, the enclosure shall withstand a prying leverage of 75 foot-pounds applied to all joints, crevices, hinges, seams and locking means. All such openings shall prevent insertion of number 10 AWG hard-drawn copper wire after the prying leverage has been applied.

## 2.10 Interrupter Switches

- A. Interrupter switches shall have a two-time duty-cycle fault-closing rating equal to or exceeding the short-circuit rating ability to close the interrupter switch twice against a three-phase fault with asymmetrical current in at least one phase equal to the rated value, with the switch remaining operable and able to carry and interrupt rated current. Tests substantiating these ratings shall be furnished with the bid.
- B. Interrupter switches shall be operated by means of an externally accessible 3/4 inch hex switch-operating hub. The switch-operating hub shall be located within a recessed pocket mounted on the side of the pad-mounted gear enclosure and shall accommodate a 3/4 inch deep-socket wrench or a 3/4 inch shallow-socket wrench with extension. The switch-operating hub pocket shall include a pad lockable access cover that shall incorporate a hood to protect the padlock shackle from tampering. Stops shall be provided on the switch operating hub to prevent over travel and thereby guard against damage to the interrupter switch quick-make, quick-break mechanism.
- C. Interrupter switches shall utilize a quick-made, quick-break mechanism installed by the switch manufacturer. The quick-make, quick-break mechanism shall be integrally mounted on the switch frame, and shall swiftly and positively open and close the interrupter switch independent of the switch independent of the switch-operating hub speed. Switches shall be the air break type.
- D. Each interrupter switch shall be completely assembled and adjusted by the switch manufacturer on a single rigid mounting frame. The frame shall be of welded steel construction such that the frame intercepts the leakage path which parallels the open gap of the circuit when the interrupter switch is in the open position.
- E. Interrupter switch contacts shall be of silver-to-silver construction for optimum current transfer, and shall be backed up by stainless steel springs to provide constant high contact pressure.
- F. Interrupter switches shall be provided with a single blade per phase for circuit closing including fault closing, continuous current carrying, and circuit interrupting. Spring-loaded auxiliary blades shall not be permitted. Interrupter switch blade supports shall be permanently molded in place in a unified insulated shaft constructed of the same cycloaliphatic epoxy resin as the insulators.
- G. Circuit interruption shall be accomplished by use of an interrupter which is positively and inherently sequenced with the blade position. It shall not be possible for the blade and interrupter to get out of sequence. Circuit interruption shall take place completely within the interrupter, with no external arc or flame. Any exhaust shall be vented in a controlled manner through a deionizing vent.
- H. Interrupter switches shall have a readily visible open gap when in the open position to allow positive verification of correct switch position.
- I. Each interrupter switch shall be provided with a folding switch-operating handle. The switch-operating handle shall be secured to the inside of the switch-operating hub pocket by a brass chain. The folded handle shall be stored behind the closed switch-operating-hub access door.
- J. Key interlocks shall be provided between each fuse-compartment door and all switches to guard against opening fuse-compartment door(s) unless all switches are locked open.

- K. Grounding studs shall be provided at all switch terminals. Grounding studs shall also be provided on the ground pad in each interrupter switch compartment and on terminals and ground pads in any cable-termination compartment. The momentary rating of the grounding studs shall equal or exceed the short-circuit ratings of the pad-mounting gear.
- L. Mounting provisions shall be provided to accommodate one three-phase fault indicator with three single-phase sensors in each switch compartment on units with more than one switch position.

#### 2.11 Fuses

- A. Fuses shall be disconnect style, solid-material power fuses, and shall utilize refill-unit-and-holder construction. The refill unit or fuse unit shall be readily replaceable and low in cost.
  - 1. Fusible elements shall be non-aging and non-damageable so that it is unnecessary to replace unblown companion fuses on suspicion of damage following a fuse operation.
  - 2. Fusible elements for refill units, rated 10 amperes or larger, shall be helically coiled to avoid mechanical damage due to stresses from surges.
  - 3. Fusible elements shall be supported in air to allow cooling after current surges to help prevent damage.
  - 4. Each refill unit shall have a single fusible element to eliminate the possibility of unequal current sharing in parallel current paths.
  - 5. Power fuses shall have melting time-current characteristics that are permanently accurate to within a total of 10% in terms of current. Time current characteristics shall be available which permit coordination with protective relays, automatic circuit reclosers, and other fuses.
  - 6. Power fuses shall be capable of detecting and interrupting all faults whether large, medium, or small (down to minimum melting current), under all realistic conditions of circuitry, with line-to-line or line-to-ground voltage across the power fuse, and shall be capable of handling the full range of transient recovery voltage severity associated with these faults.
  - 7. All arcing accompanying power fuse operation shall be contained within the fuse, and all arc products and gases evolved during fuse operation shall be vented through an exhaust control device that shall effectively control fuse exhaust.
  - 8. Power fuses shall be equipped with a blown-fuse indicator that shall provide visible evidence of fuse operation while installed in the fuse mounting.
  - 9. Fuses shall be S&C type SML-4Z units which accept type SM-4 refill units.
- B. Fuse-mounting jaw contacts shall incorporate an integral load interrupter that shall permit live switching of fuses with a hook stick.
  - 1. The integral load interrupter housing shall be of the same cycloaliphatic epoxy resin as the insulators.
  - 2. The integral load interrupter shall be in the current path continuously. Auxiliary blades or linkages shall not be used.
  - 3. Live switching shall be accomplished by a firm, steady opening pull on the fuse pull ring with a hook stick. No separate load-interrupting tool shall be required.
  - 4. The integral load interrupter shall require a hard pull to unlatch the fuse to reduce the possibility of an incomplete opening operation.
  - 5. Internal moving contacts of the integral load interrupter shall be self-resetting after each opening operation to permit any subsequent closing operation to be performed immediately.
  - 6. Circuit interruption shall take place completely within the integral load interrupter with no external arc or flame.
  - 7. The integral load interrupter and the fuse shall be provided with separate fault-closing contacts and current-carrying contacts. The fuse hinge shall be self-guiding and, together with the fault-closing contacts, shall guide the fuse into the current-carrying contacts during closing operations. Circuit-closing inrush currents and fault currents shall be picked up by the fault-closing contacts, not by the current-carrying contacts or interrupting contacts.

8. Integral load interrupters for power fuses shall have a one-time duty-cycle fault-closing capability equal to the interrupting rating of the fuse, and a two-time duty-cycle fault-closing capability of 13,000 amperes RMS asymmetrical at 14.4 KV or 25 KV. The duty-cycle fault-closing capability defines the level of available fault current into which the fuse can be closed the specified number of times (once or twice), without a quick-make mechanism and when operated vigorously through its full travel without hesitation at any point, with the integral load interrupter remaining operable and able to carry and interrupt remaining operable and able to carry and interrupt currents up to the emergency peak-load capabilities of the fuse.
- C. Fuse terminal pads shall be provided with a two-position adapter. This adapter shall accommodate a variety of cable-terminating devices.
- D. Grounding studs shall be provided at all fuse terminals. One grounding stud shall also be provided on the ground pad in each fuse compartment. The momentary rating of the grounding study shall equal or exceed the short-circuit ratings of the pad-mounted gear.
- E. A full set of fuses, plus a full set of spare fuse refills, shall be provided for each fuse position as shown on the one line diagram.

#### 2.12 Warning Signs

- A. All external doors shall be provided with permanent "Caution - High Voltage -Keep out" signs.
- B. The inside of each door shall be provided with "Danger - High Voltage -Qualified Persons Only" signs (Bilingual English, Spanish and Japanese).
- C. The inside each door providing access to interrupter switches shall be provided with warning signs indicating that "Switch Blades May Be Energized In Any Position".
- D. The inside of each door providing access to power fuses shall be provided with permanent warning signs indicating that "Fuses May Be Energized in Any Position".
- E. All warning signs shall be provided in both English and Spanish.

#### 2.13 Rating Nameplates and Connection Diagrams

- A. The outside of each door (or set of double doors) shall be provided with nameplates indicating the manufacturer's name, catalog number, and model number.
- B. The inside of each door (or set of double doors) shall be provided with nameplates indicating the following: voltage ratings (kv, nominal; kv, maximum design; and kv, BIL); main bus continuous rating (amperes); short-circuit ratings (amperes, RMS symmetrical and Mva three-phase symmetrical at rated nominal voltage); the type of fuse and its ratings (amperes, one-time/two-time duty-cycle fault-closing capability); and interrupter switch ratings (amperes, continuous; amperes, live switching - load splitting and load dropping; amperes, fault-closing, duty-cycle, two-time RMS symmetrical, RMS asymmetrical, and one-second symmetrical).
- C. A three-line connection diagram showing interrupter switches, fuses with integral load interrupter, and bus along with the manufacturer's model number shall be provided on the inside of the front and rear doors (or set of double doors), and on the inside of each switch-operating-hub access cover.

#### 2.14 Auxiliaries

- A. Holders, and refill units for original installation, as well as one spare fuse unit or refill unit for each fuse mounting shall be furnished.
- B. A fuse handling tool as recommended by the fuse manufacturer shall be furnished.



- C. One bolted connector per phase accommodating NO.2 solid through 500 MCM stranded copper or aluminum conductor shall be furnished for all switch and fuse positions.

#### 2.15 Three-Phase Fault Indicator

- A. A three-phase fault indicator shall be provided and installed with three single phase sensors in each switch compartment on all units.
- B. Fault indicators shall be provided at switching points on distribution circuits and unfused taps. A fault indicator shall be provided for each phase. Trip setting shall be as required for the given circuit. Reset shall be automatic and initiated by normal current. Fault indicators shall be type CR (10) manufactured by RTE Corporation, Waukesha, Wisconsin, or approved equal.

### PART 3 INSTALLATION

#### 3.00 Installation

- A. The switch assembly shall be mounted securely on a concrete pad minimum of six inches in thickness, designed adequately for the weight of the switch. The pad shall extend a minimum of 3' from the front of each set of doors. The switch shall be securely anchored to the pad per the manufacturer's recommendations. A ground loop shall circle the switch and provisions for grounding the switch and landing any grounds or shields shall be provided for within the enclosure. During installation all internal shields shall be left inside of the switch and shall not be left out of the cabinet or subject to exposure to the elements. Any shield which has been damaged due to neglect or exposure to the elements shall be replaced to the satisfaction of the University of Arizona Electrical Engineer.

**End of Appendix Section 16310**

**Section 16320 - PAD MOUNT TRANSFORMER**

**PART 1 GENERAL:**

1.01 Work Included Herein

- A. Pad mount transformer installations.

**PART 2 PRODUCTS:**

2.01 MANUFACTURER

- A. Acceptable Manufacturers:
  - General Electric
  - Square D
  - Cooper
  - Cutler Hammer*

2.02 TESTING

- A. Testing shall be performed in accordance with ANSI C57.12, IEEE standards 48 and 93, NEMA TR1 and TR5, and ASTM D3487.

2.03 SUBMITTALS

- A. Provide complete submittals and shop drawings on the unit including the following:
  1. Shop Drawings and catalog cuts
  2. Sufficient information to determine compliance with specifications.
  3. Include all electrical ratings, nameplate data, impedance, dimensions, weight, mounting, footprint, material, decibel ratings, terminations, temperature rise, no load and full load losses, regulation, overcurrent protection, connection diagrams, fuse sizes, fuse curves with transformer damage points, and accessories.

2.04 POWER TRANSFORMERS

- A. The transformer shall be of the *non burning or high flash point* liquid filled type. The unit shall be designed for outdoor installation a temperature variations from 0 to 45 degrees Celsius at 5% to 95% relative humidity. Cooling oil shall be in accordance with ASTM D3487.

- B. Transformer shall have the following characteristics:

1.	Continuous rating, KVA	XXX KVA
2.	Number of phases	3
3.	Number of windings	3
4.	Frequency, hertz	60
5.	Impedance, at rated KVA	5.75%
6.	High voltage winding, volts	13,800/4160 dual rated
7.	Low voltage winding, volts	120/208
8.	Temperature Rise	65° C Resistive and 80° hot spot

- C. Connections:
 

1. High-voltage winding	delta
2. Low-voltage winding	wye
3. Taps 2@+/-2.5%	yes
4. Basic Insulation Level (BIL)	
5. high-voltage winding, kV	95
- D. The windings shall have insulation of high dielectric and mechanical strength and shall be arranged to permit free circulation of cooling medium. Proper internal barriers shall be provided and additional insulation shall be provided on end coils to protect against line disturbances. The coils shall be adequately braced to prevent distortion due to any abnormal operating conditions. The windings shall withstand impulses, induced and dielectric test voltage in accordance with ANSI Standard C57.12.00.
- E. The transformers shall be furnished with a primary no-load tap changer. The transformer shall be provided with four (4) approximately 2-1/2% full capacity taps in the high voltage winding, two below and two above normal, brought out to an externally-operated, de-energized tap changer. The tap changer handle shall be capable of being locked in any tap position.
- F. The transformers shall be provided with an indicating dial thermometer, having a range from 0 degrees C. to 1 20 degrees C., indicating the transformer winding temperature.
- G. The transformers shall be furnished with two suitable ground pads on opposite sides near the bottom. The ground pads shall include a flat finished surface with NEMA drilling.
- H. The base of each transformer shall be provided with jacking pads.
- I. The transformers shall be provided with an approved nameplate conforming to the requirements of ANSI Standard C57.12.00.
- J. All windings shall be copper. Fillers or tie downs shall be provided for the coil windings.
- K. Cores shall be rigidly braced grain oriented, non aging silicon steel to minimize losses

2.05 PRIMARY EQUIPMENT

- A. The primary connections shall be live front. NOTE: Units shall have all dead front features with the exception of bolted spade type primary bushings.
- B. The primary switch shall be a gang operated load break oil immersed disconnect switch.
- C. The primary fuses shall be non load rated dry well mounted current limiting primary fuses.
- D. The entire transformer shall be of a single unit.
- E. One set of spare primary fuses shall be provided for the transformer.
- F. Provide distribution class surge arresters in the primary terminal compartment to protect the transformer primary. The arresters shall be rated at 10kv.

2.06 SECONDARY EQUIPMENT

- A. The low voltage leads shall be brought out of the tank by epoxy, pressure tight bushings, using the standard arrangement per ANSI. The neutral terminal shall be isolated from the transformer tank. A removable bonding jumper shall be provided from the secondary neutral to ground. The bonding jumper shall be sized in accordance with the NEC.

## 2.07 ENCLOSURE AND DOORS

- A. The enclosure of the transformer shall be of tamper resistant construction with no exposed screws, bolts, or other fastening devices which are externally removable.
- B. The doors shall be designed and constructed to guard against unauthorized entry.
  - 1. The high voltage compartment door shall be latched with captive bolts accessible only after the low voltage door is released and opened.
  - 2. The low voltage door shall have three point latching with a pentahead type captive bolt in the door handle for additional security. Provisions for padlocking the handle shall be included whereby the padlock cannot be engaged until the captive bolt is seated.
  - 3. Access to the tank hand hole shall be only after the low and high voltage compartment doors are opened.
  - 4. A rigid steel partition shall separate the high and low voltage compartments.
  - 5. The doors shall have full return baffles on the edges and have concealed latching mechanisms and hinges to provide maximum resistance to prying or probing with sticks, rods, or wires.
- C. Exothermically weld pad ground conductor to transformer ground pad.
- D. *Transformer shall be painted white, Dupont #817. Sand with 220 grit paper, prime with Dupont Vari-Prime, apply 3 coats of Dupont catalyzed urethane color.*

## 2.08 TRANSFORMER TANK

- A. Transformer tank shall be of sealed construction of sufficient strength to withstand a pressure on 7 psi without permanent distortion.
- B. The following shall be provided on the wall on the tank inside of the locked low voltage compartment of the transformer:
  - 1. Drain valve and sampling device
  - 2. Pressure Relief valve
  - 3. Oil filling plug
  - 4. Oil level plug
  - 5. Non corrosive metal nameplate
  - 6. Ground pad
  - 7. Oil Level gage
  - 8. Dial type thermometer
  - 9. Pressure/vacuum gage
- C. The following shall be provided on the wall on the tank inside of the locked high voltage compartment of the transformer:
  - No load tap changer handle
  - Ground pad
  - Bayonet fusing
  - Lightning arresters
- D. On the door of the secondary compartment shall have provisions for mounting a 1 5 kv rated hot stick. Hot stick shall be provided with transformer.

**PART 3 EXECUTION**

## 3.1 INSTALLATION

- A. Install complete transformer pad as indicated on drawings. Pad shall have block outs for minimum of 2 additional primary and 4 additional secondary conduits.
- B. Transformer shall be securely bolted to the concrete foundation pad in accordance with the manufacturer's recommendations.
- C. *Exothermically weld pad ground conductor to transformer ground pad.*

## 3.2 TESTING

- A. The manufacturer shall perform the following tests on each transformer prior to shipment and furnish the test results to the U of A electrical Engineer.
  - 1. Resistance measurements, ratios, polarity, and phase relation tests
  - 2. No load core loss and exciting current at rated voltage
  - 3. Impedance and load loss
  - 4. Applied potential test
  - 5. Induced potential test
  - 6. Pressure leak test
  - 7. Audible sound levels
  - 8. Temperature rise
  - 9. Impedance
  - 10. Verification of compliance from prototype testing and conformance verification
- B. Notify the U of A engineer , in writing when the transformers are ready for field testing.
- C. The electrical contractor shall adjust, test, and place the equipment into operation to the complete satisfaction of the U of A Electrical Engineer.

**End of Section 16320**

**Section 16425- MOTOR CONTROLLERS AND CONTACTORS****Introduction****Part 1 – General**

- Related Work
  - Section 16195- Electrical Identification.
  - Section 16440- Enclosed Disconnect Switches and Circuit Breakers.
  - Section 16475- Overcurrent Protective Devices.
- Reference
  - The Work under this section is subject to requirements of the Contract Documents including the General Conditions, Supplementary Conditions, and sections under Division 1 General Requirements.
- Description of Work
  - All motors will be provided ready for connections.
  - This Contractor responsible for proper phase relationships, and correct motor rotation.
  - Provide power circuit wiring for each motor from source of supply to terminal box on motor including required intermediate connections at devices such as motor starter, disconnect switches, etc.
  - Provide power circuit disconnects devices unless shown or specified to be furnished by other divisions or the owner.
  - Provide connecting lugs for equipment specified in this Section as well as for equipment furnished by other divisions or the owner.
  - Provide motor starters as specified for motors unless shown or specified to be furnished by other divisions or the owner. VDF drives shall be provided under division 15.
  - Provide control devices shown on motor schedule or as otherwise indicated.
  - Provide control wiring (except temperature control wiring) for operation, control and supervision of motorized equipment including wiring between motor starters and control devices specified and as shown on drawings.
  - Motor control wiring shall be installed in accordance with control wiring diagrams.
  - Motors ½ HP and smaller shall be served with 120 volts, single phase.
  - Motors ¾ HP and larger shall be served with 480 volt, 3 phase.
  - Starters for NEMA rated 460- volt motors 60 HP and above shall be reduced voltage starting type.
  - Reduced voltage starters shall be auto transformer type, closed transition.
- Reference Standards
  - ASME/ANSI A17.1 Safety Code for Elevators and Escalators.
  - NEMA ICS 1 Industrial Control and Systems: General Requirements.
  - NEMA ICS 2 Industrial Control and System: Controllers, Contactors and Overload Relays, rated not more than 200 Volts AC or 750 Volts DC.
  - NEMA AB- 1 Molded Case Circuit Breakers and Molded Case Switches.
  - NEMA KS- 1 Enclosed and Miscellaneous Distribution Equipment Switches (600 Volt Max.)
  - NEMA 250 Enclosures for Electrical Equipment (1000 Volts Maximum)
  - UL 580 Electric Industrial Control Equipment.
  - UL 845 Electric Motor Control Centers.

- Submittals
  - The design shown in the contract documents is based on the first listed manufacturer. If any of the other listed manufacturers are provided the performance of the equipment shall be equal to or exceed the first listed manufacturer and result in clean coordination and an uncompromised distribution system.
  - Shop drawings for equipment provided under this Section.

## Part 2 - Products

- Manufacturers
  - Cutler Hammer, Allen Bradley, General Electric, Siemens.
- Motor Control Equipment
  - Motor Starters:
    - Starters to be equipped with temperature compensated bi-metal overload relays with manual reset.
    - Manual starter to have melting alloy thermal overload relay.
    - Thermal units shall be selected on basis of nameplate horsepower, service factor and full load amps for particular motor.
    - Thermal units shall be selected on basis of measured actual full load amps of particular motor. Sizing shall be done with motor and driven device in its final and normal operating condition. Provide temporary heaters for each starter until motor is in proper operating condition, and replace with heaters sized to actual full load amps.
    - Each starter operating at other than 120 volts single phase shall have control transformer providing 120- volt control power to supply connected load plus 100% spare capacity.
      - Transformer shall have fused primary and secondary circuits.
    - Coils and pilot lights to be 120 volt. Provide surge suppressor across coil.
    - Manual starters shall be equipped with pilot light.
    - Starters shall be equipped with the following:
      - “Hand-Off-Auto” (H-O-A) selector switch.
      - 4 NO and 4 NC set of auxiliary contacts.
      - Red pilot light to indicate motor operation.
      - Green pilot light to indicate motor stopped.
      - Amber pilot light to indicate H-O-A switch in auto position.
    - Pilot lights shall be “Push-To-Test” type.
    - NEMA 3R enclosures shall also be gasketed.
  - Multi speed Starters:
    - Multi speed starters shall be equipped same as single-speed starters with addition of:
      - Speed selector switch.
      - “Auto-Off-Low-High” selector switch.
      - Compelling relay.
      - Accelerating relay/timer.
      - Decelerating relay/timer.
  - Reduced Voltage Motor Starters:
    - Autotransformer starter:
      - Closed transition.

- Magnetic Contactors:
  - Magnetic contactors shall be same as magnetic starters, except without overload protection.
- Motor Disconnect Devices:
  - Refer to Section 16440 –Disconnect Switches for disconnect switches not located in motor control centers.
  - Provide disconnect device with type FRN rejection full size fuses rated minimum of 600 volts Connected in line side of each starter.
  - Provide non-fused disconnect device at all motors.
  - Provide non-fused disconnect device at motors located on roof or located on floor different from overcurrent protective device.
  - Disconnect device shall be capable of being locked in open position.
  - Disconnect devices shall be:
    - Heavy-duty safety switch, quick-make, quick-break, horsepower rated.
    - Fused disconnect switches shall be equipped with Class RK-5 time delay fuses.
- Individual Starters and Disconnect Devices
  - Starter and disconnect device shall be installed in common enclosure, combination type, with accessories mounted in enclosure front except as scheduled.
  - Provide padlocking facility for one to three padlocks to lock disconnect in either ON or OFF position with door open or closed.
  - Provide mechanical interlock to prevent opening of door unless disconnect is in OFF position. Provide defeater to by-pass this interlock.
  - Remote disconnect switches for motors supplied from variable frequency drives (VFD) shall be equipped with pivot arm electrical interlock kit consisting of 4 NO and 4 NC contacts. Contacts to break control circuits before main switchblades open and close control circuits after main switchblades close.
  - Enclosures shall be: NEMA 1, NEMA 4X SS or NEMA 3R/12 by the spaces they are installed. NEMA 4X SS enclosures shall be required in, mechanical rooms, the main electrical equipment room, generator room, main emergency electrical room and for enclosures located exposed to the weather.
- Motor Control Centers
  - Motor Control Centers:
    - Install starters and disconnects in motor control centers, except where shown to be remote mounted at motor location.
    - Provide main breaker in the MCC, fully electronic type LSI/LSIG.
  - Motor Control Centers Shall Be:
    - 480Y/277 Volts, 3 phase 4 wire.
    - NEMA 1A gasketed enclosure except NEMA 3R gasketed enclosure in the main electrical equipment room, generator room and main emergency electrical room.
    - NEMA Class II.
    - NEMA Type B wiring.
    - Structure shall:
      - Consist of one or more vertical sections joined together to form a freestanding assembly.
      - Be minimum of 90" high, 20" wide and 15" deep for front mounted units or 20" deep for back-to-back units.
      - Have base channels with holes for bolting to floor.
      - Be designed to add matching sections on either end at future date.
  - Bus:
    - Bracing at 65,000 amps symmetrical.



- Shall be copper-tin plated.
- Horizontal Bus amp as shown on plans.
- Vertical bus size shall be same size a horizontal bus size.
- 50% Ground Bus size per NEMA standard.
- 400 AMP MCC's shall have each section rated 400 AMP.
- 300 AMP sections are not permitted.
  
- Wire ways:
  - Horizontal wire ways at top and bottom of structure.
  - Vertical wire way full height of each section.
  
- Lifting Eyes
  - Provide permanent mounted lifting eyes on all equipments shipped to the site for installation by the Contractor. Lifting eyes shall be heavy duty forged steel, located to facilitate equipment installation and removal and shall not be removed after construction is complete.

### Part 3 – Execution

- Installation
  - Provide 120 volts to each temperature control panel.
  - Install disconnects and motor control equipment as indicated. Final location of devices shall be determined in field.
  - Provide NEMA 4 disconnect switches at exterior mounted equipment.
  - Each motor terminal box shall be connected to rigid conduit system with maximum 18" of flexible liquid-tight metal conduit.
  - Provide green wire ground through flexible conduit to interconnect motor frame and rigid conduit system.
  - Check for proper rotation of each motor.
  - Install fuses per manufacturer's instructions.
  
- Elevator Connections
  - Provide power wiring from source through circuit breaker disconnect to elevator controller to motor.
  - Coordinate entire installation with elevator equipment supplier prior to rough in.
    - Installation shall comply with ASME/ANSI A17.1: Safety Code for Elevators and Escalators.

**End of Appendix Section 16425**

**Section 16435 - SWITCHBOARDS****Introduction****Part 1 - General**

- Related Work
  - Section 16070 – Seismic Anchorage and Restraint
  - Section 16075 – Electrical Identification
  - Section 16080 – Power Distribution Acceptance Testing
- Reference
  - The work under this section is subject to requirements of the Contract Documents including the General Conditions, Supplementary Conditions, and sections under Division 1 General Requirements.
- Description
  - Contractor shall furnish and install free-standing, dead-front type low-voltage distribution switchboards, utilizing group mounted circuit protective devices.
- Reference Standards
  - ANSI C37.13 – IEEE Standard for Low-Voltage AC Power Circuit Breakers Used in Enclosures
  - ANSI C37.17 – Trip Devices for AC and General Purpose DC Low-Voltage Power Circuit Breakers
  - NEMA PB2 – Dead Front Distribution Switchboards
  - NEMA KS 1 – Enclosed and Miscellaneous Distribution Equipment Switches (600 Volts Maximum)
  - UL 489 – Molded-Case Circuit Breakers, Molded-Case Switches, and Circuit-Breaker Enclosures
  - UL-891 – Dead Front Switchboards
- Submittals
  - Shop Drawings
    - Submit shop drawings for equipment provided under this section
    - Shop drawings shall indicate:
      - Manufacture and model numbers of equipment and devices
      - General arrangement:
        - Plan view indicating overall dimensions, shipping splits and weights
        - Front elevation indicating location of devices and instruments
        - Section through switchgear showing space available for conduits
      - Seismic certification and equipment anchorage details
      - Electrical one-line drawings
      - Short circuit ratings of bus and interrupting rating of lowest rated device
      - Circuit schedules showing feeder circuit identification, device description, including trip unit or fuse clip rating
      - Schematic wiring diagram
      - Cable lug termination device
    - Time current characteristics curves
      - Main breakers
      - Feeder breakers
      - Ground fault relaying

- Test data
  - Submit power distribution acceptance test reports to Engineer for review and acceptance, prior to energization of equipment.
- Instruction Manuals
  - In addition to Section 16000 – General Electrical Requirements, manual shall include the following:
    - Wiring diagrams for all systems.

#### Maintenance and Spare Parts

- Provide list of recommended spare parts
- Delivery, Storage, And Handling
  - Upon completion, assembly and testing by manufacturer of equipment specified, should it be found necessary for shipping and installation purposes to disassemble equipment, match-mark parts to facilitate erection in field.
  - Mark crates, boxes and cartons clearly to identify equipment. Show crate, box or carton identification number on shipping invoices.
  - Store switchboard units in clean, dry environment protected from elements. Maintain factory bracing, packaging and wrapping.
  - Handle units in accordance with manufacture's written handling instructions. Lift units only by manufacturers approved means.

#### Part 2 - Products

- Materials
  - Acceptable Manufactures: Cutler-Hammer, General Electric, Siemens
- Ratings
  - Assembly shall be rated to withstand fault current as shown on drawing
  - Nominal system voltage rating of switchboard shall be as shown on the drawings.
- Construction
  - Switchboard shall consist of vertical sections bolted together. Sides and rear shall be covered with removable bolt-on covers. Provide adequate ventilation within enclosure.
  - Switchboard sections shall be rear aligned. Protective devices shall be group mounted. Devices shall be front removable and load connections front accessible.
  - Assembly shall be provided with adequate lifting means.
  - Switchboard shall be suitable for use as service entrance equipment.
- Bus
  - General
    - Bus bars shall be silver-plated copper.
    - Main horizontal bus bars shall be mounted with all three phases arranged in same vertical plane.
    - Bus sizing shall be based on 65°C over 40°C ambient temperature outside the enclosure.
    - Provide a full capacity neutral bus.
    - Provide copper ground bus, sized per NEMA Standards, extending entire length of switchgear.

- Bus Bar Connection
  - Bus bar connections shall be bolted.
  - Bus joints shall be provided with conical spring-type washers.
  - Clamp joints shall not be used.
- Wiring Terminations
  - Provide small wiring, necessary fuse blocks and terminal blocks within switchboard.
  - Control components mounted within assembly, such as fuse blocks, relays, pushbuttons, switches, etc., shall be suitably marked for identification corresponding to appropriate designations on manufacturer's wiring diagrams.
  - Mechanical-type terminals shall be provided for all line and load terminations suitable for copper cable rated for 75°C.
  - Lugs shall be provided in incoming line section for connection of main grounding conductor.
  - Control wire shall be type SIS.
    - Control wire shall be bundled and secured with nylon ties.
    - Insulated locking spade terminals shall be provided for all control connections, except where saddle type terminals are provided integral to a device.
    - Current transformer secondary leads shall be connected to short-circuit terminal blocks.
    - Groups of control wires leaving the switchboard shall be provided with terminals blocks with suitable numbering strips. Provide wire markers at each end of control wiring.
- Protective Devices
  - Main Breaker
    - Main breaker shall be fixed insulated case circuit breaker, fully electronic, LSIG/LSI.
    - Breaker shall be listed for 100% continuous ampere rating.
    - Main breaker shall be provided with solid-state trip units.
    - Frame ampere ratings shall be as shown on drawings.
    - Main breakers shall be manually operated (MO).
  - Feeder Breakers
    - Feeder breakers shall be fully electronic molded case circuit breakers or Power Circuit Breakers, LSI. Thermal magnetic breakers are not acceptable.
    - Circuit breakers shall have minimum of symmetrical interrupting capacity as indicated on drawings.
    - Circuit breakers 200-ampere through 2500-ampere shall have microprocessor-based RMS sensing trip units.
  - Solid State Trip Units
    - Provide breakers, with solid-state microprocessor based trip units.
      - Unit shall consist of current sensors, solid-state trip device, flux transfer shunt trip and solid-state adjustable time/current curve shaping elements.
    - Solid state elements shall provide:
      - Long time current pickup settings and long time delay bands.
      - Short time current pickup settings and short time delay bands.
      - Instantaneous trip settings with switchable 12t ramp.
      - Ground fault pickup settings (where indicated on drawings).
    - Adjustments shall be made using non-removable, discrete steps.
    - Sealable transparent cover shall be provided over adjustments.

- Ground Fault (where indicated on drawings):
  - Trip shall be provided as an integral part of breaker.
  - Pick-up shall be adjustable with maximum setting of 1200 amps.
  - Time delay shall be adjustable.
- Trip unit shall contain means to conduct circuit breaker tests.
- Breaker shall be equipped with externally accessible test points to be used for field testing.
  
- Customer Metering
  - Provide customer metering compartment with hinged door.
    - Current transformers for each meter. Current transformers shall be wired to shorting-type terminal blocks.
    - Potential transformers including primary and secondary fuses with disconnecting means.
  - Meter shall be microprocessor-based as manufactured by Veris.
  - The unit shall display the following:
    - Phase amperes (A, B, C).
    - Phase voltage (A-B, B-C, C-A, A-N, B-N, C-N).
  
- Enclosures
  - NEMA 1 Enclosure
  - Finish
    - Exterior and interior of switchboard shall be ANSI-61 light gray.
  
- Accessories
  - Lockout Devices:
    - Provide circuit breakers with integral, lockout/tagout devices.
  - Shunt trip devices:
    - Provide shunt trip bell alarms and auxiliary switches.
  
- Nameplates
  - Nameplates shall be secured to switchboard enclosure with screws.
  - Switchgear assembly:
    - Switchgear shall be provided with nameplate indicating manufacturer's name and drawing number.
      - In addition to name and drawing number, provided:
        - Voltage ratings (kV nominal; kV maximum design; kV BIL)
        - Main bus continuous rating (amperes)
        - Short-circuit ratings (amperes, rms symmetrical and Mva three-phase symmetrical)
        - Momentary and fault-closing ratings (amperes, rms asymmetrical)
      - Control components mounted within assembly shall be marked for identification corresponding to appropriate designation on manufacture's drawings.

### Part 3 - Execution

- Inspection
  - Visually inspect equipment and components at time of delivery. Submit report to Owner/Engineer with list of items to be corrected.

- Factory Testing
- Standard Factory Tests Shall Be Performed On Equipment Provided Under This Section.
  - Switchboard shall be completely assembled, wired, adjusted, and tested at factory.
  - Manufacturer shall provide 3-certified copies of factory test reports.
- Installation
  - Contractors shall install equipment per manufacturer's instructions and contract drawings.
  - Assembly shall be provided with adequate lifting means and shall be capable of being moved into installation position and bolted directly to floor without use of floor sills provided floor is level to 1/8 inch per 3-foot distance in any direction. Necessary hardware to secure assembly in place shall be provided by Contractor.
  - Provide 4-inch high housekeeping pad for switchboards as indicated on drawings. Pad footprint shall be size to adequately support switchboard. Bolt switchboard securely to pad.
  - Protect equipment during installation to prevent twisting or deformation, exposure to damaging environments, and work of other trades. Maintain protection until completion of construction.
  - Prior to energization, factory representative shall visually inspect switchgear installation to insure that switches and motor operators are operable and bus connections are complete.
- Field Quality Control
  - Contractor shall perform field adjustments of protective devices as required to place equipment in final operating condition. Settings shall be in accordance with approved short-circuit study, protective device evaluation study and protective device coordination study.
  - Necessary field settings of devices and adjustments and minor modifications to equipment to accomplish conformance with approved short circuit and protective device coordination study shall be carried out by Contractor at no additional cost to Owner.
  - Immediately prior to final inspection, thoroughly clean equipment. Refinish damaged enclosures to original quality.
- Acceptance Testing
  - Perform Acceptance tests on switchboard in accordance with Section 16080 – Power Distribution Acceptance Tests. Adjust or replace equipment as needed to comply with manufacturer's specifications. Re-test device and submit new test reports.
  - Equipment shall have passed acceptance tests prior to energization.
  - Certified test report of standard production tests shall be available to Engineer upon request.
  - Switch operators shall be tested at least once after energization.
- Training
  - Contractor shall provide training session for up to [XXX] Owner's Representatives for one normal workday at a jobsite location determined by Owner.
    - Training session shall be conducted by Manufacturer's Qualified Representative. Training program shall consist of instruction on operation of assembly, circuit breakers, fused switches, and major components within assembly.

**End of Appendix Section 16435**

**Section 16620 - NATURAL GAS ENGINE GENERATOR SET**

## PART I-GENERAL

## 1.1 GENERAL

## PROJECT NO.

- A. The requirements specified in GENERAL - general requirements of this project shall apply to and govern the work under CSI Division I except where indicated in the following articles.

## 1.2 WORK INCLUDED

- A. Provide all labor, materials and equipment to furnish, install and place in operation a natural gas power generation system in accordance with the contract documents and manufacturer's drawings and installation instructions. These specifications also describe requirements for the design, fabrication and testing of the power system. The total installation shall conform to manufacturer's recommendations.
- B. The installation of the power generation system shall include the following:

- Engine-driven generator set
- Control system
- Cooling system
- Connection to natural gas system
- Generator set accessories
- Mounting system
- System control and switchgear
- Base slab and vibration isolation
- Weatherproof housing, sound attenuated

## 1.3 RELATED WORK

Refer to the following specifications for related mechanical and electrical considerations:

- Section 16000 - Electrical Work
- Section 16260 - Automatic Transfer Switch

## 1.4 SYSTEM DESCRIPTION

- A. The electric power generating system shall have a site capability of xxx kw, xxx kva, under continuous standby operation.
- B. The system shall consist of a natural gas generator set which includes all controls, protection, output circuit breaker, wiring, and accessories for automatic start-stop operation.
- C. The overload capability shall be in excess of this rating, at extreme limits of parameters specified, for not less than 1 hour.

Where air temperature extremes are not the case, test results will be extrapolated. The results shall be as interpreted by the University of Arizona Electrical Engineer.

- D. The generator set shall include the capability of automatically controlling generator set operation. After starting, the unit will attain rated speed and voltage, and accept rated load. Generator set speed shall be controlled by the engine governor, while generating output voltage regulation shall be a function of the generator automatic voltage regulator. Manual adjustment of generator speed and voltage shall be provided.
- E. The generator set start-stop sequence shall be initiated manually or automatically by closing or opening of a contact. The control system shall automatically engage the cranking motor, sense engine starting speed, disengage the motor and arm the engine protection circuit.
- F. The set shall immediately shut down in the event of overspeed, low oil pressure, high water temperature and overcrank. Cause of shutdown shall be indicated by a light annunciator. System logic shall prevent restart until fault is cleared.

There shall be a provision for manual shutdown in the event of an emergency.

1.5 SITE CONDITIONS

The operating environment of the power generating system shall be:

Altitude	2400 ft.
Engine room temperature, max	125 F
Outside temperature, min	20 F
Outside Temperature max	115 F
Fuel type	Natural Gas
Fuel pressure (gas)	Verify pressure for specific site by contacting FDC

1.6 SYSTEM PERFORMANCE, GENERAL

- A. The power generating system shall conform to the following performance criteria:
  - 1. Rating - Engine brake horsepower shall be sufficient to deliver full rated generator set KW/KVA at the installation site when operated at rated rpm and equipped with all engine-mounted parasitic and external loads such as radiator fans and power generators.
  - 2. The Gas engine shall be able to deliver rated power when operating on dry natural gas having a low heating value (LHV) of 905 Btu/cu ft (33.74 kJ/L).
  - 3. Gas Engine fuel rates shall be based on fuel having a low heating value (LHV) of 905 Btu/cu ft. (33.74 kJ/L).
  - 4. Start Time and Load Acceptance - Engines shall start, achieve rated voltage and frequency, and be capable of accepting load within 10 seconds when properly equipped and maintained.
  - 5. Block Load Acceptance - Transient response shall conform to ISO 8528 requirements.



- B. The power generating system shall satisfy the following performance criteria at site conditions:
 

Total Power Capability	xxx Kw
Frequency	60 Hz
Voltage	480/2771/3 phase 4 wire
Voltage Dip starting Largest Motor sequence	20%
Power Factor	0.8
Overload for 1 Hour	10%
  
- C. The individual generator set shall exhibit the following performance capability: Caterpillar xxx model. Other manufacturer's are Waukesha, Cummings, Onan, Generc, prior approved. Contact Robert Cousy, P.E., (621-9252) for approval prior to bid due date.

1.7 QUALITY ASSURANCE

- A. The complete power generation system, including engine, generator, and switchgear shall be the product of one manufacturer who has been regularly engaged in the production of complete generating systems for at least 10 years. All components shall have been designed to achieve optimum physical and performance compatibility and prototype tested to prove integrated design capability. The complete system shall have been factory fabricated, assembled, and production tested as performed by Caterpillar, or prior approved systems.

1.8 RESPONSIBILITY

- A. The responsibility for performance to this specification shall not be divided among individual component manufacturers, but must be assumed solely by the primary manufacturer. This includes generating system design, manufacture, test, and having a local supplier responsible for service, parts, and warranty for the total system.

1.9 SUBASSEMBLY AND PACKAGING

- A. Generator set mounted subassemblies such as cooling system, base, air intake system, exhaust outlet fittings, and generator set mounted controls and switchgear shall also be designed, built, and assembled as a complete unit by the engine - generator manufacturer.

1.10 PRODUCTION TESTS

- A. The system manufacturer shall perform post production tests on the generator set supplied. A certified report of these tests shall be available when requested at the time of the generator set order.

1.11 DRAWINGS/SCHEMATICS

- A. All installation drawings and wiring diagrams for the generator set, controls, and switchgear must conform to a common formats of 8 1/2" x 11", 11" x 17" and 24" x 36".

1.12 SUBMITTALS

A. Submittals shall include but not be limited to:

1. Component List - A breakdown of all components and options including switch gear.
2. Technical Data - Manufacturer produced generator set specification or data sheet identifying make and model of engine and generator, and including relevant component design and performance data.

a. Engine:

Type, aspiration, compression ratio, and combustion cycle.  
 Bore, stroke, displacement, and number of cylinders.  
 Engine lubricating oil capacity.  
 Engine coolant capacity without radiator.  
 Engine coolant capacity with radiator.  
 Coolant pump external resistance (maximum). Where remote radiator is specified

3. Generator: Model  
 Model  
 Frame  
 Insulation class  
 Number of Leads  
 Weight, total  
 Weight, rotor  
 Air Flow

At rated voltage:

Efficiency at 0.8 power factor for: 50% load, 75% load, 100% load  
 Fault current, 3 phase symmetrical  
 Decrement curve

4. Radiator: (High Ambient, Brass)  
 Model  
 Type  
 Coolant capacity, radiator  
 Coolant capacity, radiator and engine  
 Weight: Dry, Wet

5. System:  
 Dimensions: Length, Width, Height  
 Weight: Dry, Wet

- Performance in 115°F air, 2400 MSL.

Continuous power rating at 0.8 power factor (KW) kVA rating  
 Fuel consumption at standard conditions for:  
 50%, 75% and 100% load Heat rejection to:  
 coolant, after-cooler, exhaust, atmosphere from engine, and atmosphere

from generator  
Exhaust gas stack temperature  
Exhaust gas components; % NOX, % SO  
Tons particulate/yr/mo at 50%, 100% load  
Verification of 10% overload capability

- B. Transient response of frequency and voltage for the generator set:
- C. Auxiliary Equipment - Specification or data sheets, including switchgear, spring type vibration isolators.
- D. Drawings - General dimensions drawings showing overall generator set measurements, mounting location, and interconnect points for load leads, fuel, exhaust, cooling and drain lines.
- E. Wiring Diagrams - Wiring diagrams, schematics and control panel outline drawings published by the manufacturer in Joint Industrial Council (JIC) format for controls and switchgear showing interconnected points and logic diagrams for use by contractor and owner.
- F. Warranty Statements - Warranty verification published by the manufacturer.
- G. Service - Location and description of supplier's parts and service facility including parts inventory and number of qualified generator set service personnel.

#### 1.13 SERVICE AND WARRANTY

- A. The manufacturer shall have a local authorized dealer who can provide factory trained servicemen, the required stock of replacement parts, technical assistance, and warranty administration.
- B. The manufacturer's authorized dealer shall have a parts and service facility within 130 miles of the jobsite.
- C. The generator set supplier shall have factory trained service representatives and tooling necessary to install, test, maintain, and repair all provided equipment.

#### 1.15 WARRANTY ADMINISTRATION

- A. The manufacturer's authorized dealer shall be capable of administering the manufacturer's and dealer's warranty for all components supplied by the selling dealer (who may or may not be the same as the servicing dealer).

#### 1.16 WARRANTY TERMS

- A. The manufacturer's and dealer's standard warranty shall in no event be for a period of less than two (2) years from date of initial start-up of the system and shall include repair parts, labor, reasonable travel expense necessary for repairs at the jobsite, and expendables (lubricating oil, filters, antifreeze, and other service items made unusable by the defect) used during the course of repair. Running hours shall not be a limiting factor for the system warranty by either the manufacturer or servicing dealer. Submittals received without written warranties as specified will be rejected in their entirety.

- B. The manufacturer's and dealer's extended warranty shall in no event be for a period of less than five (5) years from date of initial start-up of the system or 2500 operating hours, whichever comes first. It shall include repair parts, labor, reasonable travel expense necessary for repairs at the jobsite, and expendables (lubricating oil, filters, antifreeze, and other service items made unusable by the defect) used during the course of repair. Applicable deductible costs shall be specified in the manufacturer's warranty. Submittals received without written warranties as specified will be rejected in their entirety.

#### 1.21 WARRANTY NAMEPLATE

- A. A warranty nameplate of not less than 152 mm x 203 mm (6 in x 8 in) must be affixed to the generator set with the following data:

Warranty Period:

Start-up Date:

Termination Date:

Supplier Name:

Supplier Address:

24-Hour Emergency Number:

Preventive maintenance to be performed by:

#### 1.22 MAINTENANCE CONTRACT

- A. The generator set supplier shall offer a maintenance and repair contract which guarantees all support costs of the specified system. It shall include routine and 24 hour emergency access to a factory account manager to expedite emergency repairs. This shall be priced during the bid process as an additive bid item.
- B. The contract shall protect the user from parts and labor price increases, and shall provide a refund of residual funds at any time of user dissatisfaction. Optional payment schedules shall include fixed rate throughout the life of the contract.

#### 1.23 PARTS AVAILABILITY

- A. The generator set supplier shall have sufficient parts inventory to maintain over the counter availability of at least 90% of any normal wear and tear parts. (Bets, hoses, filters, turbines, pumps, safeties, regulators, injectors, gaskets)
- B. The generator set supplier shall guarantee overnight 100% parts from the time an order is entered with the dealer.

#### 1.24 OIL SAMPLING SERVICE

- A. The generator set supplier shall provide a scheduled oil sampling service to monitor engine condition on an ongoing basis. The sampling method shall be of the atomic absorption spectrophotometry method.

Immediate notification of critical results shall be provided to the owner's representative.

**PART 2- PRODUCTS****2.1 PRODUCTS**

- A. The following articles and paragraphs are intended to define a power generation system of proven type and design, of current production, and with all components commercially available.
- B. Approved systems, subject to conforming to the Specifications are Caterpillar, Generac and Cummins/Onan.
- C. These products shall be from vendors with factory approval as stocking dealer – distributors with evidence of having supplied and serviced units of equal size and performance for at least 5 years.
- D. Generators shall be designed to provide not less than 110% output, based on specified capacity, for a period of 2 hours at temperature extremes.

**2.2 ENGINE**

- A. The engine shall be a stationary, liquid cooled, 1800 rpm, four-cycle design, vertical in-line or V-type, with Dry exhaust manifolds. It shall have cylinders with minimum displacement of xx liters and be manufactured in the United States.

**2.3 ENGINE EQUIPMENT**

- A. The engine shall be equipped with air filters, fuel filters and pressure gauge, lubricating oil cooler, filters, and pressure gauge, water pump and temperature gauge, service hour meter, flywheel, and flywheel housing.

**2.4 LUBRICATION SYSTEM**

- A. The lubrication oil pump shall be a positive displacement type that is integral with the engine and gear driven from the engine gear train. The system shall incorporate full flow filtration with bypass valve to continue lubrication in the event of filter clogging.
- B. The bypass valve must be integral with the engine filter base or receptacle. Systems where bypass valves are located in the replaceable oil filter are not acceptable. Pistons shall be oil cooled by continuous jet spray to the underside or inside of the crown and piston pin.
- C. System shall utilize synthetic lubricants with compatible filtration, and compatible engine seals, approved by the engine manufacturer.

**2.5 GASEOUS FUEL SYSTEM**

- A. The gaseous fuel system shall consist of gas pressure regulators and carburetors. The carburetor shall be a diaphragm type which includes a load screw for air-fuel ratio adjustment, and throttle body to control the air-fuel mixture to the engine.

## 2.6 IGNITION SYSTEM

- A. The ignition system shall be the low tension type and consist of magneto, transformers, and spark plugs. The magneto shall be of solid state design and spark plugs will incorporate gold palladium electrodes for reliability and life.

## 2.7 GOVERNOR

- A. The engine governor shall control engine speed and transient load response within commercial and ISO 8528 tolerances. It will be selected, installed, and tested by the generator set manufacturer.

## 2.8 GOVERNOR, ELECTRONIC-SPEED CONTROL

- A. The engine governor shall be a Woodward 2301 Electronic Speed Control with EG Electro-Hydraulic Actuator or Barber Coleman Equal. Speed droop shall be externally adjustable from 0 (isochronous) to 10% from no load to full rated load. Steady state frequency regulation shall be  $\pm 0.25$  percent.

## 2.9 COOLING SYSTEM

- A. The engine jacket water cooling system shall be a closed circuit design with provision for filling, expansion, and de-aeration. The cooling pump shall be driven by the engine. Auxiliary coolant pumps required for heat exchangers or separate circuit after cooling shall also be engine driven. Coolant temperature shall be internally regulated to disconnect external cooling systems until operating temperature is achieved.

## 2.10 RADIATOR, ENGINE-MOUNTED

- A. Heat rejected to the engine jacket water shall be discharged to the atmosphere through a close coupled radiator. The radiator shall be sized to cool the engine continuously while operating at full rated load and at site conditions of 115°F ambient.

## 2.11 FAN AND BELT GUARDING

- A. The fan, fan drive, and fan belts shall be covered with punched steel mesh guarding for personnel protection. The guarding shall conform UL 2200.

## 2.12 BLOWERFAN

- A. The radiator cooling fan shall be a blower type driven from the engine. Air shall be drawn from the engine side and exhausted through the radiator core with no more than 12.7 mm (0.5 in) of water external restriction in addition to core restrictions.

## 2.13 INLET AIR SYSTEM

- A. The engine air cleaner shall be engine mounted with dry element requiring replacement no more frequently than 250 operating hours or once each year.

## 2.14 TURBOCHARGING

- A. Only single stage turbo charging shall be allowed.

## 2.15 AFTERCOOLING

- A. After-cooler core air surfaces shall be coated with a corrosion inhibitor to minimize oxidation.

## 2.16 EXHAUST SYSTEM

- A. The engine exhaust system shall be installed to discharge combustion gases quickly and silently with minimum restriction. System including silencer shall be designed for minimum restriction, and in no case shall back pressure exceed 6.7 kPa.
- B. Heavy walled piping such as Schedule 40 is preferred, with radii of 90 bends at least 1-1/2 times the pipe diameter. Piping shall be installed with 229 mm (9 in) minimum clearance from combustible material or incorporate appropriate insulation and shielding.
- C. Piping shall be supported and braced to prevent weight or thermal growth being transferred to the engine and flexible expansion fittings provided to accommodate thermal growth. Support dampers and springs shall be included where necessary to isolate vibration. Install in accord with manufacturer's recommendations.
- D. Long runs of pipe shall be pitched away from the engine and water traps installed at the lowest point. Exhaust stacks shall be extended to avoid nuisance fumes and odors. And outlets cut at 45° to minimize noise. Aim outlet to northwest as directed.

## 2.17 SILENCER-CRITICAL

- A. Provide critical silencer in accordance with Paragraph 2.32 E.
- B. The silencer shall have an end inlet and end outlet.

## 2.18 PACKAGED SYSTEMS

- A. Submit for individual approval in lieu of Paragraph 2.16.

## 2.18 ELECTRIC STARTING SYSTEM

- A. The engine starting system shall include 24 volt DC starting motor(s), starter relay, and automatic reset circuit breaker to protect against butt engagement. Batteries shall be maintenance free, lead acid type mounted near the starting motor. A corrosion resistant or coated steel battery rack shall be provided for mounting. Required cables will be furnished and sized to satisfy circuit requirements. The system shall be capable of starting engine within 10 seconds. 12 v systems will be considered for 75 kw or less units by prior approval.

## 2.19 JACKET WATER HEATER

- A. Jacket water heater(s) shall be provided to maintain coolant temperature of 32 C (90 F) while the engine is idle. Heaters shall accept 208 volt AC single phase power and include adjustable thermostats.

## 2.20 BATTERIES

- A. Batteries for starting and control shall be selected and supplied by the generator set manufacturer. They shall be a heavy duty SLI lead acid type with through-partition connectors, and housed in a hard rubber or polypropylene case with provision for venting.
- B. Battery warranty shall be the responsibility of the generator set manufacturer.

## 2.21 ALTERNATOR

- A. An engine mounted belt driven battery charging alternator shall be installed with an automatic voltage regulator. It shall be suitable for heavy duty applications with a rating of 24 volts.

## 2.22 INSTRUMENTATION-ENGINE

- A. The engine mounted instrument panel shall consist of a shock-mounted formed and welded enclosure primed for coastal environment. Provide Metric/English marked gauges. Gauges shall include: engine oil pressure, oil filter differential, fuel pressure, jacket water temperature, electric service meter and running time meter.

## 2.23 GENERATOR

- A. The generator shall be equivalent to caterpillar model xxx and shall be rated for Standby service at xxx kw, xxx KVA, 0.8 PF, xxx V, three phase, wire, 60 Hz, 1800 rpm.
- B. The generator shall be capable of withstanding a three phase load of 300% rated current for 10 seconds, and sustaining 150% of continuous load current for 2 minutes with field set for normal rated load excitation.
- C. It shall exhibit less than 5% waveform deviation at no load.
- D. Generator efficiencies shall be calculated according to IEC 34-2 Section 4, with all current squared times R losses corrected to 115 F.

## 2.24 STRUCTURE

- A. The generator shall be close coupled, drip proof and guarded, constructed to NEMA I and IP 22 standards, single bearing, salient pole, revolving field, synchronous type with amortisseur windings in the pole faces of the rotating field.

## 2.25 MECHANICAL DESIGN - SINGLE BEARING

- A. The generator housing shall be one piece and mount directly to the engine flywheel housing without bolted adaptors.

## 2.26 WINDINGS

- A. Thermal Class 200 magnet wire as described by NEMA Magnet Wire Standard MW 1000, Section MW 35-C, shall be used for rotor and stator windings. The windings shall consist of copper magnet wire. All winding insulation materials shall be Class H in



accordance with BS and IEEE standards.

#### 2.27 OPERATING ENVIRONMENT

- A. The generator shall be designed to operate in a sheltered drip-proof environment.

#### 2.28 EXCITER-PERMANENT MAGNET

- A. The permanent magnet excitation system shall derive excitation current from a pilot exciter mounted on the rotor shaft. It shall enable the generator to sustain 300% of rated current for ten seconds during a fault condition.

#### 2.29 VOLTAGE REGULATOR - SEALED

- A. The automatic voltage regulator shall be manufactured by the manufacturer of the engine generator set. The volts/hertz regulator shall sense line-to-line three phases of generator output voltage and exhibit the following characteristics:
1. Generator output voltage maintained within +/- 1% of rated value for any load variation between no load and full load.
  2. Generator output voltage drift no more than +/- 1/2% of rated value at constant temperature.
  3. Generator output voltage drift no more than **+1-** 1% of rated value within a 40° change over ambient temperature range of -40° C to 70° C.
  4. Generator frequency change not over ¼ cycle no load to full load and back.
  5. Response time less than 20 milliseconds.
  6. Telephone Influence Factor (TIF) of less than 50.
  7. Electronic Interference/Radio Frequency Interference (EMI/RFI) suppressed to commercial standards.
  8. The regulator shall include the following features:
    - a. Voltage level rheostat to provide generator output voltage adjustment of -25% to +10% of nominal.
    - b. Gain adjustment to provide output voltage compensation for changes in load or frequency.

#### 2.30 MOUNTING BASE-STANDBY PACKAGE

- A. The base shall be constructed of formed "C" section steel members with minimum 6 mm thickness. Corners shall be squared to provide rodent/bird proof joint when enclosure is added. Provision shall be made for four corner lifting. It shall incorporate flexible fuel lines, external oil and coolant drains and external crankcase fumes disposal hose. Support cross members shall add rigidity and allow installation of vibration isolators between base and generator set. Generous space for ground stub-ups between the

members shall be provided. The base shall include bottom mounting holes.

### 2.31 ISOLATOR-SPRING TYPE

- A. Steel spring isolators shall be installed between the generator set base and the mounting surface. The isolators shall bolt to the base, and have a waffled or ribbed pad on their bottom surface. The pads shall be resistant to heat and age, and impervious to oil, water, antifreeze, diesel fuel, and cleaning compounds

### 2.32 ENCLOSURE - STANDBY PACKAGE, FULL

- A. The enclosure shall offer protection as specified by OSHA from all moving and hot parts of the engine, generator and radiator. It shall be constructed to allow full access to the engine for maintenance without exposing personnel to any moving machinery. Radiator and radiator fan assembly shall be totally enclosed with lockable door over the radiator cap. The radiator shall be sized to accommodate any resulting air flow restrictions. Provision shall be made for a duct flange or perforated metal grill to protect the radiator core. Doors shall be the lift off hingeless type with lockable stainless steel security latches.
- B. Louvers shall allow sufficient air flow to allow full load operation of the generator set. The louvers shall be twisted to deflect water and direct noise downward. The enclosure shall satisfy IEC 1P22 requirements for drip proof construction acceptable for outside installation when doors are in place.
- C. The enclosure shall be fitted to the generator set base and isolated from engine vibration. Corners shall be formed and welded to assure strength and rigidity. Sheet metal with minimum thickness of 2.0 mm for enclosure and 1.2 mm for doors shall have no burrs or sharp edges. Inside and outside surfaces shall be finished with a baked high performance enamel. Exposed fasteners shall be minimized with all hardware stainless steel.
- D. Outdoor generator enclosures shall be sage green, Federal standard 595b, 14449.

### 2.32 CONTROLS, PROTECTION AND MONITORING

- A. The controls, protection and monitoring systems of the generator set and its operation shall be the responsibility of the generator set manufacturer. All subsystem components, interfaces, and logic shall be compatible with engine mounted devices.

### 2.33 AUTOMATIC START-STOP CONTROL

- A. The control panel shall be shock mounted on the generator and have the capability to face either side or the rear of the generator. The 24 volt DC system shall incorporate energize to run logic and include:
  - 1. Control:
    - a. Generator voltage level rheostat and ammeter/voltmeter phase selector switch shall be mounted on the panel door.

- b. The engine start-stop switch shall be door mounted and include positions for off/reset, manual, automatic and stop.
2. Shutdowns/Annunciation:  

The generator set shall shut down and individual red lights shall signal operational faults of high water temperature, low oil pressure, overspeed and overcrank.
3. Monitor:  

Monitoring devices shall include AC voltmeter, AC ammeter, ammeter/voltmeter phase select switch, frequency meter, electric hourmeter, oil pressure gauge, and water temperature gauge.
4. Safety Devices:  

ISO red emergency stop pushbutton shall be provided, and all controls, annunciation, and monitors labeled with ISO symbols.
5. Cycle Cranking  

A cycle crank timer shall provide five 10 second cranking periods separated by 10 second rest periods.
6. Engine Cool Down  

A cool down timer shall provide an adjustable 0-30 minute engine running period before shutdown after removal of load set at 15 min.
7. Alarm Module  

NFPA-99 requirements for the alarm panel shall be satisfied by a 24 volt DC alarm module mounted in the panel and including red indicating lights and silencable alarm horn to annunciate alarm conditions for high and low coolant temperature, low oil pressure, low DC voltage, and system not in automatic.
8. Battery Charger  

The battery charger is to be a solid-state device with adjustable float voltage control. It is to be a constant voltage device with current limit, and it is to include an equalize switch which will allow the battery to be overcharged for maintenance purposes.
9. Overvoltage, Undervoltage and Underfrequency Protection  

The controls will include devices to protect against overvoltage, undervoltage, underfrequency and overfrequency output from the generator. This protection must sense voltage and frequency directly and controls which attempt to measure these values by measuring excitation current will not be acceptable.

## 10. Emergency Stop Switch

The engine controls will be arranged to stop the engine if a remote maintained contact emergency stop switch is depressed. Once the switch has been operated, it should not be possible to start the engine until the stop switch is released. The "Switch Off Normal" indicating lamp on the front of the panel and the remote engine fail alarm must both be activated if the stop switch has been operated.

## 2.34 CIRCUIT BREAKER-GENERATOR SET MOUNTED

- A. The circuit breaker shall be mounted and connected in a guarded drip-proof enclosure. Cable lugs shall be provided for customer connections.
- B. One molded case electronic circuit breaker, three pole, single-throw, stationary-mounted with manual operating handle, overload and short circuit trips, complete with cable lugs. Overcurrent trip shall be 100% rated and sized to provide enclosed and ambient temperature compensation. The breaker shall be qualified for 600 volt operation and tested in accordance with UL Standard 489, LSI / LSIG. Breaker shall be adjustable to allow for 110% output test.
- C. One shunt trip, 24 volt DC, on circuit breaker wired to terminal board.
- D. Three current transformers, 5 ampere secondaries.
- E. One ground connection point.

## 2.35 REMOTE ANNUNCIATOR PANEL

- A. NFPA-99 requirements for remote annunciation shall be satisfied by a remote mounted electro-mechanical panel which includes red and yellow indicating lights and silencable alarm horn for low oil pressure shutdown, low coolant temperature alarm, high coolant temperature, shutdown, overcrank, overspeed shutdown, battery charger malfunction (via charger switch), generator on load (via Customer switch). Install where directed by the University.

## 2.36 AUTOMATIC TRANSFER SWITCH

- A. The automatic transfer switch shall be as specified in the specification.

## 2.37 WEATHERPROOF SOUND ATTENUATING ENCLOSURE

- A. Enclosure shall be sound attenuating enclosure: the engine-generator set shall be factory enclosed in not less than a 12 gauge steel enclosure constructed with corner posts, uprights and headers. The roof shall aid in the runoff of water and include a drip edge. The enclosure shall be coated with electrostatically applied paint, baked and finished to manufacturers specifications. The enclosure shall be completely lined with not less than 1" thick, UL 94 HF-1 listed, sound deadening material. This material must be of a self extinguishing design. The critical silencer shall be included to further reduce the unit sound level. The overall design must be such that sound level is 75dbA at 7 meters (23 feet) or less.
- B. Exhaust silencer(s) shall be provided of the size as recommended by the manufacturer

and shall be of critical grade to attenuate the sound to the level noted above. It shall be supplied with a flexible, seamless, stainless steel exhaust connection. A rain cap will be supplied to terminate the exhaust pipe. These components must be properly sized to assure operation without excessive back pressure when installed.

### **PART 3- EXECUTION**

#### **3.1 EXECUTION**

- A. The following articles and paragraphs are intended to define acceptable procedures and practices of inspecting, installing, and testing the generator set and associated equipment.

#### **3.2 PREDELIVERY INSPECTION**

- A. A pre-delivery inspection must be performed by the system manufacturers' local dealer at the dealer's facility to insure no damage occurred in transit and all genset components, controls, and switchgear are included as specified herein.

#### **3.3 PREDELIVERY TESTING**

- A. Prior to delivery and acceptance, the generator set shall be tested to show it is free of any defects and will start automatically and carry full load. This testing shall be performed at the facility of the system manufacturer's authorized local dealer.
- B. The testing shall be done on dry type, resistive load banks.
- C. The load banks shall not be dependent on the generator control instruments to read amperage and voltage on each phase. Rather, the test instrumentation will serve as a check of the generator set meters.
- D. Load bank testing shall be done in the presence of the owner's engineer or his appointed representative. After manufacturers approved break-in procedure, sample oil, change oil and performance testing, forward oil test results to U of A Engineer. Testing shall be for a minimum of 1 hour at 80% load, 1 hr. at 100% load, 2 hrs. at 110% load, 1.0 pf. Demonstrate voltage dips and frequency dips with block loading. If breaker trips, record time run at 110°
- E. All consumables necessary for testing shall be furnished by the bidder. Any defects which become evident during the test shall be corrected by the bidder at his own expense prior to shipment to the jobsite.

#### **3.4 SHIPMENT TO JOBSITE**

- A. Delivery shall be FOB to the jobsite by the system manufacturer's authorized dealer.

#### **3.5 INSTALLATION**

- A. The installation shall be performed in accordance with shop drawings, specifications, and the manufacturer's instructions.

### 3.6 FIELD QUALITY CONTROL

- A. The complete installation shall be checked for procedural and operational compliance by a representative of the system manufacturer's authorized local dealer. The engine lubricating oil and antifreeze, as recommended by the system manufacturer, shall be provided by the generator set dealer. If switchgear and generator sets are furnished by different manufacturers, technical representatives of both manufacturers' authorized dealers shall verify the installation meets requirements. Any deficiencies shall be noted and corrected by the Contractor.
- B. The system manufacturer's dealer representative shall be present to assist the Contractor during start-up, systems check, adjusting, and site testing required after the installation is complete. Re run the pre delivery test and then test the oil. (Do not change the oil.)

### 3.7 POST-INSTALLATION TESTING

- A. Following installation, the following tests shall be performed by the system manufacturer's local dealer representative(s) in the presence of the owner's engineer or designated appointee.

### 3.8 PRESTART CHECKS

- Oil level
- Water level
- Day tank fuel level
- Battery connection and charge condition
- Air start supply pressure (if so equipped)
- Engine to control interconnects
- Engine generator intake/exhaust obstructions
- Removal of all packing materials

### 3.9 OPERATION

- A. Load - two hours operation at 80% of full load rating. One hour operation at 100% of full load rating and one hour at 110°C. After the first half-hour stabilization period at full load, the following shall be recorded at fifteen minute intervals (starting at time equals "zero"):
  - 1. Voltage, amperage, frequency
  - 2. Fuel pressure, oil pressure and water temperature
  - 3. Exhaust gas temperature at engine exhaust outlet
  - 4. Ambient temperature
- B. If equipped with appropriate instrumentation:
  - 1. Kilowatts
  - 2. Power Factor

3. KVARs
  4. Generator Temperature
- C. Proper operation of controls, engine shutdown, and safety devices shall be demonstrated.

### 3.10 ORIENTATION

- A. The system manufacturer's authorized dealer shall provide a complete orientation for the owner's engineering and maintenance personnel. Orientation shall include both classroom and hands-on instruction. Topics covered shall include control operation, schematics, wiring and diagrams, meters, indicators, warning lights, shutdown system and routine maintenance.

### 3.11 SERVICE MANUALS AND PARTS BOOKS

- A. The system manufacturer's authorized local dealer shall furnish one copy each of the manuals and books listed below for each unit under this contract:
1. OPERATING INSTRUCTIONS - with description and illustration of all switchgear controls and indicators and engine and generator controls.
  2. PARTS BOOKS - that illustrate and list all assemblies, subassemblies and components, except standard fastening hardware (nuts, bolts, washers, etc.).
  3. PREVENTATIVE MAINTENANCE INSTRUCTIONS - on the complete system that cover daily, weekly, monthly, biannual, and annual maintenance requirements and include a complete lubrication chart.
  4. ROUTINE TEST PROCEDURES - for all electronic and electrical circuits and for the main AC generator.
  5. TROUBLESHOOTING CHART - covering the complete generator set showing description of trouble, probable cause and suggested remedy.
  6. RECOMMENDED SPARE PARTS LIST - showing all consumables anticipated to be required during routine maintenance and test.
  7. WIRING DIAGRAMS AND SCHEMATICS - showing function of all electrical components.
- B. All manuals and books described above shall be contained in rigid plastic pouches.

### 3.12 CONTRACT MAINTENANCE

- A. The system manufacturer's authorized dealer shall furnish the owner's engineer with a copy of any contract maintenance agreement negotiated relative to the equipment specified in this section. The contract information shall detail agreed maintenance intervals, work to be performed at each interval, reimbursement schedule for maintenance work, and owner's responsibilities versus dealer's responsibilities.

**End of Appendix Section 16620**



**Section 16621 - AUTOMATIC TRANSFER SWITCH****Part 1 – General**

- 1.01 One 600 Amp, 3 Phase, 480 Volt Automatic Transfer Switch (ATS) shall be provided with gasketed enclosure. The ATS shall consist of an inherently double throw power transfer switch unit and a control module interconnected to provide complete automatic operation. The operating transfer time\* in either direction shall not exceed one-sixth (1/6) of a second.
- 1.02 Refer to Specification 16622 for isolation bypass transfer switches.

**Part 2 – Products**

- 2.01 The transfer switch unit shall be electrically operated and mechanically held. The electrical operator shall be a single-solenoid mechanism, momentarily energized to minimize power consumption and heat generation. The switch shall be positively locked and unaffected by voltage variations or momentary outages so that contact pressure is maintained at a constant value and temperature rise at the contacts is minimized for maximum reliability and operating life. The switch shall be mechanically interlocked to ensure only one of two possible positions – normal or emergency.
- 2.02 All main contacts shall be silver composition.
- 2.03 Inspection of all contacts (movable and stationary) shall be possible from the front of the switch without disassembly of operating linkages and without disconnection of power conductors. A manual operation handle shall permit the operator to stop the contacts at any point throughout the entire travel to properly inspect and service the contacts when required.
- 2.04 A control module shall direct the operation of the transfer switch. The module's sensing and logic shall be controlled by a built-in microprocessor for maximum reliability, minimum maintenance and inherent digital communications capability. The control module shall be connected to the transfer switch by an interconnecting wiring harness. The harness shall include a keyed disconnect plug to enable the control module to be disconnected from the transfer switch for routine maintenance.
- 2.05 The control panel shall meet or exceed the voltage surge withstand capability in accordance with IEEE standard 472-1974 (ANSI C37, 90a-1974) and the impulse withstand voltage test in accordance with the proposed NEMA Standard ICS 1-109.

---

\* Operating transfer time is the time measured from instant of monitored source deviation to closing of main contacts on an available alternate power source exclusive of any purposefully introduced time delay.

2.06 Operation:

- A. The voltage of each phase of the normal source shall be monitored, with pickup adjustable from 85 to 100% and dropout adjustable from 75 to 98% of pickup setting, both in increments of 1%, and shall be fully field-adjustable without the use of any tools, meters or power supplies. Repetitive accuracy of settings shall be +/- 2% or better over an operating temperature range of -20C to -70C. Factory set to pickup at 90% voltage and 95% frequency.

- B. The control module shall include four time delays that are fully adjustable over the entire range as follows:
  - 1. Time delay to override momentary normal source outages to delay all transfer switch and engine starting signals. Adjustable from 0 to 6 seconds. Factory set at 1 second.
  - 2. Transfer to emergency time delay. Adjustable from 0 to 5 minutes. Factory set at 0 minutes unless indicated otherwise on the plans.
  - 3. Retransfer to normal time delay. Time delay is automatically bypassed if emergency source fails and normal source is acceptable. Adjustable from 0 to 30 minutes. Factory set at 10 minutes.
  - 4. Unload running item delay for emergency engine generator cool down. Adjustable from 0 to 60 minutes. Factory set at 15 minutes.
  - 5. Exercising and cool down clocks.
  - 6. All standard features commonly shown in manufacturer's literature.
  
- 2.07 A set of DPDT gold-flashed contacts rated 10 Amps, 48 VDC shall be provided for a low-voltage engine start signal when the normal source fails. The start signal shall prevent dry cranking of the generator by requiring the generator to reach proper output and to run for the duration of the cool down setting regardless of whether the normal source restores before the load is transferred. Also provide a "commit/no commit to transfer" selector switch to select whether the load should be transferred to the emergency generator if the normal source restores before the generator is ready to accept the load.
  
- 2.08 A momentary-type test switch shall be provided to simulate a normal source failure. Also, terminals for a remote contact which opens to signal the ATS to transfer to emergency and terminals for remote contacts which open to inhibit transfer to emergency and/or retransfer to normal shall be provided.
  
- 2.09 Output terminals to signal the actual availability of the normal and emergency sources, as determined by the voltage sensing pickup and dropout settings for each source, shall be provided.
  
- 2.10 One set of auxiliary contacts shall be provided rated 10 Amps, 480 VAC consisting of one contact closed when the ATS is connected to normal and one contact closed when the ATS is connected to emergency. Also, one set of signal lights to indicated when the ATS is connected to normal source and when the ATS is connected to emergency source shall be provided.
  
- 2.11 See attached sheet 6 figure #1 for maximum allowable dimensions of ATS without enclosure.
  
- 2.12
  - 1. For each switch provide trouble shooting hints.
  - 2. For each switch provide O & M manual.
  - 3. For each switch provide complete ladder schematic.
  - 4. For each switch provide wiring diagram.
  - 5. For each switch provide parts list.

2.12 Switching Monitor: Manufacturer shall provide one of the following:

A. Inphase Monitor:

An inphase monitor shall be built-in to the ATS and shall control transfer so that motor load inrush currents do not exceed normal starting currents to avoid nuisance tripping of circuit breakers and possible mechanical damage to motor couplings. The inphase monitor shall operate without external control of electrical loads and without any external control of the power sources. The monitor shall compare the phase relationship and frequency difference between the normal and emergency sources and permit transfer can be accomplished within 60 electrical degrees as determined by monitoring the frequency difference. Inphase transfer shall be accomplished if the sources are within 2 Hz of nominal frequency and 70% or more of nominal voltage.

B. Programmed Monitor:

Monitor shall detect motor decay and provide delayed open transition switching where in phase monitors are provided as part of the software. Provide UofA with codes to activate and deactivate.

2.13 Code Compliance:

The ATS shall conform to the requirements of:

- A. 3 cycle rating in excess of UL 1008 – Standard for Automatic Transfer Switches. (Fully rated.)
- B. UL 1008 – Standard for Automatic Transfer Switches. Optional 3 cycle testing.
- C. NFPA 70 – National Electrical Code including use in emergency and standby systems in accordance with Articles 571, 700, 701 and 702.
- D. NFPA 99 – Essential Electrical Systems for Health Care Facilities.
- E. NFPA 110 – Standard for Emergency and Standby Power Systems.
- F. IEEE Standard 446 – IEEE Recommended Practice for Emergency and Standby Power Systems (Orange Book).
- G. IEEE Standard 241 – IEEE Recommended Practice for Electric Power Systems in commercial buildings (Gray Book).
- H. NEMA Standard ICS – 2-447 – AC Automatic Transfer Switches.
- I. IEC – Standard for Automatic Transfer Switches.
- J. The ATS shall be UL listed in accordance with UL 1008 as follows:

- 1. Rated in amperes for total system transfer including control of motors, electric-discharge lamps, electric-heating and tungsten-filament lamp loads as referred to in Paragraph 38.13 of UL 1008.

2. Overload and endurance at 480 Volts AC per tables 25.1, 25.2, 27.1 and 27.2 of UL 1008 when enclosed according to Paragraph 1.6.
  3. Temperature rise tests after the overload and endurance tests to confirm the ability of the transfer switches to carry their rated current within the allowable temperature limits.
  4. No welding of contacts. Transfer switch must be electrically operable to alternate source after the withstand current tests.
  5. Dielectric tests at 1960 Volts, RMS, minimum after the withstand current tests.
  6. Additional optional testing for 3 cycle compliance.
- K. The ATS shall be "fully" rated to withstand the RMS symmetrical short circuit current available at the ATS terminals for 3 full cycles, verified by oscillograph testing by an independent test agency, in EXCESS of UL 1008, without series protection of fuses or circuit breakers.

### Part 3 Execution

- 3.01 All production units shall be subjected to the following factory tests:
- A. The complete ATS shall be tested to ensure proper operation of the individual components and correct overall sequence of operation and to ensure that the operating transfer time, voltage, frequency and time delay settings are in compliance with the specification requirements.
  - B. The switch shall be subjected to a dielectric strength test per NEMA Standard ICS 1-109.21.
  - C. ATS must be monitored by Fire Alarm System and report to the UA fire Safety Shop.
- 3.02 The manufacturer shall provide a notarized letter certifying compliance with all of the requirements of this specification including compliance with the above codes and standards and withstand current ratings. The certification shall identify by serial number(s) the equipment involved. No exceptions to the specifications other than those stipulated at the time of submittal shall be included in the certification.
- 3.03 Manufacturer
- A. The ATS manufacturer shall maintain a local service center capable of emergency service or routine preventative maintenance contracts. The manufacturer shall maintain records of each switch by serial number for minimum of 20 years.
  - B. The ATS manufacturer shall provide same day emergency parts available to customer.
  - C. Whenever the words "AS MAY BE DIRECTED", "SUITABLE", "OR EQUIVALENT", "AS APPROVED", or other words of similar intent and meaning are used implying that judgment, discretion, or decision is to be exercised, it is understood that it is the judgment, discretion, or decision of the Owner to which the reference is made. All materials and articles necessary for the work are subject to the approval of the Owner.

**DIVISION 16 ELECTRICAL**

**PROJECT NO.**

- D. The following manufacturers are approved, subject to approval, based on conformance to this specification:
- i. Russelectric
  - ii. Others: By prior approval submittal. 3 cycle testing in excess of UL 1008 is required prior to the prior approval submittal.

**End of Appendix Section 16621**

**Section 16622 - \*AUTOMATIC TRANSFER SWITCH, ISOLATION BYPASS TYPE**

**Part 1 – General**

- 1.01 Required capacity, (Refer to Contract Drawings), 3 Phase, 480 Volt Isolation Bypass Automatic Transfer Switch (ATS) shall be provided with enclosure. The ATS shall consist of an inherently double throw power transfer switch unit and a control module interconnected to provide complete automatic operation. The operating transfer time\* in either direction shall not exceed one-sixth (1/6) of a second.

**Part 2 – Products**

- 2.01 The transfer switch unit shall be electrically operated and mechanically held. The electrical operator shall be a single-solenoid mechanism, momentarily energized to minimize power consumption and heat generation. The switch shall be positively locked and unaffected by voltage variations or momentary outages so that contact pressure is maintained at a constant value and temperature rise at the contacts is minimized for maximum reliability and operating life. The switch shall be mechanically interlocked to ensure only one of two possible positions – normal or emergency.
- 2.02 All main contacts shall be silver composition.
- 2.03 Inspection of all contacts (movable and stationary) shall be possible from the front of the switch without disassembly of operating linkages and without disconnection of power conductors. A manual operation handle shall permit the operator to stop the contacts at any point throughout the entire travel to properly inspect and service the contacts when required.
- 2.04 A control module shall direct the operation of the transfer switch. The module's sensing and logic shall be controlled by a built-in microprocessor for maximum reliability, minimum maintenance and inherent digital communications capability. The control module shall be connected to the transfer switch by an interconnecting wiring harness. The harness shall include a keyed disconnect plug to enable the control module to be disconnected from the transfer switch for routine maintenance.
- 2.05 The control panel shall meet or exceed the voltage surge withstand capability in accordance with IEEE standard 472-1974 (ANSI C37, 90a-1974) and the impulse withstand voltage test in accordance with the proposed NEMA Standard ICS 1-109.
- 2.06 Operation:
  - A. The voltage of each phase of the normal source shall be monitored, with pickup adjustable from 85 to 100% and dropout adjustable from 75 to 98% of pickup setting, both in increments of 1%, and shall be fully field-adjustable without the use of any tools, meters or power supplies. Repetitive accuracy of settings shall be +/- 2% or better over an operating temperature range of -20C to -70C. Factory set to pickup at 90% voltage and 95% frequency.

---

\* Operating transfer time is the time measured from instant of monitored source deviation to closing of main contacts on an available alternate power source exclusive of any purposefully introduced time delay.

- B. The control module shall include four time delays that are fully adjustable over the entire range as follows:
  - 1. Time delay to override momentary normal source outages to delay all transfer switch and engine starting signals. Adjustable from 0 to 6 seconds. Factory set at 1 second.
  - 2. Transfer to emergency time delay. Adjustable from 0 to 5 minutes. Factory set at 0 minutes unless indicated otherwise on the plans.
  - 3. Retransfer to normal time delay. Time delay is automatically bypassed if emergency source fails and normal source is acceptable. Adjustable from 0 to 30 minutes. Factory set at 10 minutes.
  - 4. Unload running item delay for emergency engine generator cool down. Adjustable from 0 to 60 minutes. Factory set at 15 minutes.

2.07 A set of DPDT gold-flashed contacts rated 10 Amps, 48 VDC shall be provided for a low-voltage engine start signal when the normal source fails. The start signal shall prevent dry cranking of the generator by requiring the generator to reach proper output and to run for the duration of the cool down setting regardless of whether the normal source restores before the load is transferred. Also provide a “commit/no commit to transfer” selector switch to select whether the load should be transferred to the emergency generator if the normal source restores before the generator is ready to accept the load.

2.08 A momentary-type test switch shall be provided to simulate a normal source failure. Also, terminals for a remote contact which opens to signal the ATS to transfer to emergency and terminals for remote contacts which open to inhibit transfer to emergency and/or retransfer to normal shall be provided.

2.09 Output terminals to signal the actual availability of the normal and emergency sources, as determined by the voltage sensing pickup and dropout settings for each source, shall be provided.

2.10 One set of auxiliary contacts shall be provided rated 10 Amps, 480 VAC consisting of one contact closed when the ATS is connected to normal and one contact closed when the ATS is connected to emergency. Also, one set of signal lights to indicated when the ATS is connected to normal source and when the ATS is connected to emergency source shall be provided.

2.11 See attached sheet 6 figure #1 for maximum allowable dimensions of ATS without enclosure.

- 2.12
  - 1. For each switch provide trouble shooting hints.
  - 2. For each switch provide O & M manual.
  - 3. For each switch provide complete ladder schematic.
  - 4. For each switch provide wiring diagram.
  - 5. For each switch provide parts list.

2.12 Switching Monitor: Manufacturer shall provide one of the following:

A. Inphase Monitor:

An inphase monitor shall be built-in to the ATS and shall control transfer so that motor load inrush currents do not exceed normal starting currents to avoid nuisance tripping of circuit breakers and possible mechanical damage to motor couplings. The inphase monitor shall operate without external control of electrical loads and without any external control of the power sources. The monitor shall compare the phase relationship and frequency difference between the normal and emergency sources and permit transfer can be accomplished within 60 electrical degrees as

determined by monitoring the frequency difference. Inphase transfer shall be accomplished if the sources are within 2 Hz of nominal frequency and 70% or more of nominal voltage.

System shall have the ability to be manually switched to a mode that drops the load long enough to allow motor decay and reenergize on the alternate source. This is where the two sources are utilities, or sourced from the same utility.

**B. Programmed Monitor:**

Monitor shall detect motor decay and provide delayed open transition switching.

**2.13 Code Compliance:**

The ATS shall conform to the requirements of:

- A. 3 cycle rating in excess of UL 1008 – Standard for Automatic Transfer Switches. (Fully rated.)
- B. NFPA 70 – National Electrical Code including use in emergency and standby systems in accordance with Articles 571, 700, 701 and 702.
- C. NFPA 99 – Essential Electrical Systems for Health Care Facilities.
- D. NFPA 110 – Standard for Emergency and Standby Power Systems.
- E. IEEE Standard 446 – IEEE Recommended Practice for Emergency and Standby Power Systems (Orange Book).
- F. IEEE Standard 241 – IEEE Recommended Practice for Electric Power Systems in commercial buildings (Gray Book).
- G. NEMA Standard ICS – 2-447 – AC Automatic Transfer Switches.
- H. IEC – Standard for Automatic Transfer Switches.
- I. The ATS shall be UL listed in accordance with UL 1008 as follows:
  - 1. Rated in amperes for total system transfer including control of motors, electric-discharge lamps, electric-heating and tungsten-filament lamp loads as referred to in Paragraph 38.13 of UL 1008.
  - 2. Overload and endurance at 480 Volts AC per tables 25.1, 25.2, 27.1 and 27.2 of UL 1008 when enclosed according to Paragraph 1.6.
  - 3. Temperature rise tests after the overload and endurance tests to confirm the ability of the transfer switches to carry their rated current within the allowable temperature limits.
  - 4. No welding of contacts. Transfer switch must be electrically operable to alternate source after the withstand current tests.
  - 5. Dielectric tests at 1960 Volts, RMS, minimum after the withstand current tests.
  - 6. *Additional optional testing for 3 cycle compliance.*



- J. The ATS shall be rated to withstand the fault current noted on the contract drawings single line diagram, at the ATS terminals, for 3 full cycles, verified by ocillograph testing by an independent test agency, in EXCESS of UL 1008 without series protection of fuses or circuit breakers.

**Part 3 Execution**

3.01 All production units shall be subjected to the following factory tests:

- A. The complete ATS shall be tested to ensure proper operation of the individual components and correct overall sequence of operation and to ensure that the operating transfer time, voltage, frequency and time delay settings are in compliance with the specification requirements.
- B. The switch shall be subjected to a dielectric strength test per NEMA Standard ICS 1-109.21.

3.02 The manufacturer shall provide a notarized letter certifying compliance with all of the requirements of this specification including compliance with the above codes and standards and withstand current ratings. The certification shall identify by serial number(s) the equipment involved. No exceptions to the specifications other than those stipulated at the time of submittal shall be included in the certification.

3.03 Manufacturer

- 5. The ATS manufacturer shall maintain a local service center capable of emergency service or routine preventative maintenance contracts. The manufacturer shall maintain records of each switch by serial number for minimum of 20 years.
- 6. The ATS manufacturer shall provide same day emergency parts available to customer.
- 7. Whenever the words “AS MAY BE DIRECTED”, “SUITABLE”, “OR EQUIVALENT”, “AS APPROVED”, or other words of similar intent and meaning are used implying that judgment, discretion, or decision is to be exercised, it is understood that it is the judgment, discretion, or
- 8. Decision of the Owner to which the reference is made. All materials and articles necessary for the work are subject to the approval of the Owner.
- 9. The following manufacturers are approves, subject to approval, based on conformance to this specification:
  - A. Russelectric Bypass Isolation Switch.
  - B. Zenith Bypass Isolation Switch
  - C. Others: By prior approval submittal. 3 cycle testing in excess of UL 1008 is required prior to the submittal.

**End of Appendix Section 16622**

## APPENDIX

## SECTION 16720 – FIRE ALARM SYSTEMS

## PART 1 - GENERAL

## 1.1 WORK INCLUDED

- A. The work covered by this section of the specifications includes the furnishing of all labor, equipment, materials, and performance of all operations in connection with the installation of the Fire Alarm System as shown on the drawings and as herein specified.
- B. The work covered by this section of the specifications is to be coordinated with the related work as specified elsewhere under the project specifications.
- C. The intent of this project is to provide a complete, independent fire alarm for this building.
- D. These specifications require a system that exceeds the requirements of the State Fire Code (SFC).

## 1.2 RELATED WORK

- A. The drawings, general requirements, conditions of the contract, including General and Supplementary Conditions and Division 1 Specification Sections, apply to this section.
- B. The work described in this section has related work with:
  - Section \_\_\_\_\_ Electrical General Provisions
  - Section \_\_\_\_\_ Identification
  - Section \_\_\_\_\_ Electrical Demolition
  - Section \_\_\_\_\_ Conduit Systems
  - Section \_\_\_\_\_ Wire and Cable
  - Section \_\_\_\_\_ Grounding

## 1.3 SYSTEM DESCRIPTION

- A. Furnish a complete Class A Fire Alarm System as described herein and as shown on the plans; wire, connect, and leave in first class operating condition. Include a Fire Alarm Control Panel, manual pull stations, automatic fire detectors, horns, strobes, combination horn/strobes, annunciator, and remote control devices. Use closed loop initiating device circuits with individual zone supervision, individual indicating appliance circuit supervision, and incoming and standby power supervision.

Provide Style D initiating circuits, Style Z signaling circuits, Style 6 communications circuits, all wiring, connections to devices, outlet boxes, junction boxes, and all other necessary material for a complete operating system.
- B. Allow for loading or editing special instructions and operating sequences in the Fire Alarm Control Panel as required. Provide a system capable of on site programming to accommodate and facilitate expansion, building parameter changes or changes as required by the owner, authorities having jurisdiction and code requirements. Provide storage for all fire alarm system software operations in a non-volatile, programmable memory within the Fire Alarm Control Panel. Loss of primary and secondary power will not erase the instructions stored in memory.
- C. Provide final as built in .dxf file format, sized and scaled for used on 4190 Generalized Computer Center (GCC)

- D. Incorporate in the resident software programming of the system the full ability for selective input/output control functions based on ANDing, ORing, NOTing, timing and special coded operations.
- E. Provide a system that communicates with all initiating and control devices individually on a multiple addressable peripheral network (MAPNET). Annunciate all initiating and control devices individually at the Fire Alarm Control Panel. Include the following annunciation conditions for each point:
- Alarm
  - Trouble
  - Open
  - Short
  - Ground
  - Device Fail or Incorrect Device
- F. Provide a system capable of individually disabling or enabling all addressable devices. Field configure all devices to allow for the addition of devices on a circuit after the initial installation.
- G. Provide a system capable of multi-dropping up to 127 addressable devices from a single pair of wires.
- H. Provide a system capable of having software programming modified and initiating or control devices added or deleted in the field. Systems that require factory reprogramming to add or delete devices are unacceptable.
- I. Provide all necessary software on disk or cd along with any required software keys to allow the University to program changes, additions, removals or re-labels. This includes the programming software for the FACP's and the GCC's.
- J. Provide a system with a completely digital, poll/response protocol communications format. System to use parity data bit error checking routines for address codes and check sum routines for the data transmission protocol to achieve a high degree of communication reliability. Systems that do not utilize full digital transmission protocol (i.e. that may use time pulse width methods to transmit data etc.) are not acceptable.
- K. Provide a system where each addressable device is uniquely identified by an address code entered on the base of each device at time of installation. The use of jumpers to set address will not be acceptable due to the potential of vibration and poor contact.
- L. Provide a system capable of supporting up to 10,000 feet wire length for each initiation circuit loop.
- M. ALARM SEQUENCE
1. The system alarm operation subsequent to the alarm activation of any manual station, automatic detection device, or sprinkler flow switch is to be as follows:
    - a. Sound a continuous fire alarm signal on all audible alarm indicating appliances until silenced by the alarm silence switch at the Fire Alarm Control Panel or the remote annunciator.
    - b. Flash strobes continuously on all visual alarm indicating appliances until System is reset.
    - c. Release all doors normally held open by door control devices.

- d. Send a supervised signal to notify the central monitoring station (UAPD). To accommodate and facilitate job site changes the type of "city connection circuit" is to be on site configurable to provide either a "reverse polarity", "local energy", "shunt" or dry contact connection.
  - e. Activate/deactivate mechanical controls on the air handling systems per specifications of the owner and in accordance with NFPA 101 - Life Safety Code. Sequentially restart air handling units upon system reset to reduce electrical demand.
  - f. Display an alarm condition on the Fire Alarm Control Panel display per 2.3.A of these specifications. Flash the alarm LED on the Fire Alarm Control Panel and the remote annunciator until the alarm has been acknowledged at the Fire Alarm Control Panel or the remote annunciator. Latch the alarm LED on upon alarm acknowledgement. After the alarm has been acknowledged, flash the alarm LED on the Fire Alarm Control Panel and the remote annunciator again upon receipt of a subsequent alarm from another device/zone. Display the new alarm information on the Fire Alarm Control Panel display.
  - g. Provide a pulsing alarm tone that will occur within the Fire Alarm Control Panel and the remote annunciator until acknowledged. Provide a pulsing alarm tone that is capable of being disabled or removed if so specified by the owner.
2. All elevator connections shall be per schematic diagram 16720-D1 at end of this section, below is a sequence of operations for the elevator connections;
    - a. The alarm activation of any elevator lobby smoke detector will cause the elevator cabs to be recalled according to the following sequence:
      1. Recall the elevator cabs to the main egress floor (as indicated by the owner and authority having jurisdiction) upon the activation of an elevator lobby smoke detector on any floor other than the main level of egress.
      2. Recall the elevator cabs to the predetermined (as indicated by the owner and authority having jurisdiction) alternate level of egress upon the activation of the elevator lobby smoke detector on the main egress level.
    - b. The alarm activation of any elevator machine room or hoist way heat detector will cause the shunt trip control to be activated for a thirty, (30,) second period and activate a red indicating light near the controlled breaker.
    - c. The presence of shunt trip control power shall be indicated by a green light installed at the same location as the red light required in 16720, 1.3, M, 2, b.
    - d. The loss of shunt trip control power will cause a supervisory condition to be displayed on the Fire Alarm Control Panel.
    - e. The alarm activation of any elevator machine room or hoist way smoke detector will cause the fireman's hat in the cab to flash.
    - f. The presence of generator power for load shall be reported to the elevator controller.
  3. Provide a manual evacuation switch to operate the systems alarm indicating appliances leaving other control circuits in their normal state.
  4. Override the automatic alarm functions either selectively or throughout the system upon activation of auxiliary bypass keys or bypass groups.

5. Immediately display alarm and trouble conditions on the Fire Alarm Control Panel front alphanumeric display. If more alarms or troubles are in the system the operator may scroll to display new alarms.
6. Provide a system with a list key that will allow the operator to display all alarms, troubles, and supervisory service conditions with the time of occurrence. This shall allow for the determination of not only the most recent alarm but also may indicate the path that the fire is taking.
7. All doors normally held open by door control devices shall release upon AC power failure.
8. Generator Controls and Monitoring. (This applies to each generator installed).
  - a. Provide a control ZAM or Relay IAM connected to the generator controls to cause the generator to start and transfer the emergency load to generator power.
  - b. Provide a control ZAM or Relay IAM connected to the generator controls to cause the generator to emergency stop.
  - c. Provide an IAM connected to the generator controls to monitor if the generator is running.
  - d. Provide an IAM connected to the generator controls to monitor if the generator system has a fault.
9. Main Building Emergency Power Off, (EPO)
  - a. Provide a control ZAM or Relay IAM tie into the main EPO circuit to allow for EPO activation.
  - b. Install a Model #2088-9007 powered by the EPO circuit and wired to be normally energized. Connect an IAM to common normally closed side of the Model #2088-9007 to monitor the presence of EPO control power.

#### N. SUPERVISION

1. Provide a system with Class 'A' (Style 'D') independently supervised initiating circuits so that a fault in any one zone/device does not affect any other zone/device and so that an alarm activation of any initiation circuit does not prevent the subsequent alarm operation of any other initiation circuit.
2. Provide sprinkler supervisory initiation device circuits for connection of all sprinkler valve tamper switches to perform the Supervisory Service Operation. Wiring methods which affect any fire alarm initiation circuits to perform this function will be deemed unacceptable; i.e.: sprinkler and standpipe tamper switches (N/C contacts) shall NOT be connected to circuits with fire alarm initiation devices (N/O contacts). Label this independent initiation circuit as Supervisory Service and provide differentiation between tamper switch activation and wiring faults.
3. Provide independently supervised and independently fused indicating appliance circuits for horns and strobes. Disarrangement conditions of any of these circuits will not affect the operation of other circuits.
4. Supervise all auxiliary manual controls so that all switches must be returned to the normal automatic position to clear system trouble.

5. Include a discrete Fire Alarm Control Panel readout for each independently supervised circuit to indicate disarrangement conditions per circuit.
6. Supervise the incoming power to the system so that any power failure must be audibly and visually indicated at the Fire Alarm Control Panel. A green "power on" LED shall be displayed continuously while incoming power is present.
7. Supervise the system batteries so that a low battery condition or disconnection of the battery shall be audibly and visually indicated at the Fire Alarm Control Panel.
8. Supervise any system expansion modules for module placement. Should a module become disconnected from the controls, the system trouble indicator must illuminate and audible trouble signal must sound.
9. Supervise wiring to a hardwired (non-serial) remote annunciator for open and ground conditions. Provide a separate annunciator trouble readout that will illuminate an LED and sound an audible trouble signal at the Fire Alarm Control Panel upon the detection of an open or ground condition.
10. Provide independent supervision for opens of the air handling on/off/auto switch control output wiring. Provide a discrete trouble panel readout per output circuit for indication. Provide indication of a common ground trouble on the Fire Alarm Control Panel in the presence of a ground condition of the air handling control output wiring.
11. Supervise all slave module LEDs for burnout or disarrangement. Should a problem occur, the Fire Alarm Control Panel shall display the module and the LED location numbers to facilitate location of that LED.

O. POWER REQUIREMENTS

1. Provide the Fire Alarm Control Panel with 120VAC 20AMP power via a dedicated fused disconnect circuit.
2. Provide the system with sufficient battery capacity to operate the entire system upon loss of normal 120 VAC power in a normal supervisory mode for a period of twenty-four (24) hours with 5 minutes of alarm operation at the end of this period. Automatically transfer the system to the standby batteries upon primary power failure. All battery charging and recharging operations shall be automatic.
3. Provide 24VDC from the Fire Alarm Control Panel to all circuits requiring system operating power. Individually fuse all these circuits at the Fire Alarm Control Panel.

1.4 QUALITY ASSURANCE

- A. Provide each and all items of the Fire Alarm System that are the products of a SINGLE fire alarm system manufacturer under the appropriate category by Underwriters' Laboratories, Inc. (U.L.), and bearing the "UL" label. Provide control equipment that is all listed under UL category UOJZ as a single control unit. Partial listing is NOT acceptable.
- B. Provide each and all items of the Fire Alarm System that are the products of a single manufacturer (independent dealers and/or distributors will NOT be considered) who has engaged in the production of this type of equipment (software driven) for at least 10 years, and has a fully equipped service organization within fifty (50) miles of this installation.

- C. Furnish fire alarm equipment installation supervision from a factory trained and certified manufacturer's representative (independent dealers and/or distributors will NOT be considered) who has been engaged in the installation of this type of equipment (software driven) for at least ten (10) years.
- D. Provide system controls that are UL listed for Power Limited Applications per NEC 760, in addition to the UL-UOJZ requirement mentioned above. Mark all circuits in accordance with 2005 NEC article 760 and these specifications.
- E. Provide transient protection devices on all control equipment to comply with UL864 requirements.
- F. Provide additional transient protection must be provided for each circuit, where fire alarm circuits leave the building. Provide devices that are UL listed under Standard 497B (Isolated Loop Circuit Protectors).

## 1.5 REFERENCES

- A. Install the complete system in conformance with the applicable sections of NFPA 72, NFPA 71, NFPA 70, Local Code Requirements, and National Electrical Code with particular attention to Article 760 and other standards listed in Section 16010.
- B. Install and configure the entire fire alarm system and integrated system operations in conformance with the State of Arizona Fire Code.

## 1.6 SUBMITTALS

- A. Submit complete fire alarm layout drawings and equipment cut sheets prior to beginning any construction work on the Fire Alarm System. Depict on the layout drawings all equipment and field devices, routing of wiring, connection information, MAPNET identification number for each device, etc.
- B. Submit fire alarm shop drawings to the State Fire Marshal for approval prior to beginning any construction work on the Fire Alarm System.

## 1.7 DELIVERY, STORAGE, AND HANDLING

- A. Store all fire alarm equipment (Fire Alarm Control Panel, all peripheral devices, equipment enclosures, etc.) in an environmentally controlled location until required on project site. Store all fire alarm equipment at the project site in an environmentally controlled location until installed.

## 1.8 WARRANTY

- A. Provide a warranty for the completed fire alarm system wiring and equipment to be free from inherent mechanical, electrical, and software programming defects for a period of two (2) years from the date of the completed and certified test by the Authority Having Jurisdiction.
- B. Provide from the equipment manufacturer to the owner a maintenance contract proposal to provide a minimum of two (2) years of complete annual tests and inspections in compliance with NFPA-72 guidelines.

## PART 2 - PRODUCTS

### 2.1 ACCEPTABLE MANUFACTURERS

- A. Provide panels and peripheral devices that are all the standard product of a single manufacturer, displaying the manufacturer's name on each component. Provide a fire alarm system that is manufactured by SimplexGrinnell, Inc. The catalog numbers specified under this section are those of SimplexGrinnell, Inc. and constitute the type, product quality, material, and desired operating features.

2.2 MATERIALS

A. WIRING

1. The following wiring requirements apply in addition to other wiring requirements found elsewhere in these specifications.
2. Use only wiring type approved by the fire alarm equipment manufacturer.
3. Color Coding for fire alarm wiring is listed below. Use solid color compound or solid color coating on all conductors. Identify with colored tape wire sizes for which colored insulation is not available.

<u>Circuit Type</u>	<u>Color Code</u>	<u>To What</u>	<u>Wire Size</u>
Halon Signal Wiring A/Vs & V/Os	Red / Black	Signal Module	#14
Halon Low Tank Pressure Switch	Orange / Brown	IAM	#14
Halon Tank Discharge Switch	Orange / Brown	IAM	#14
Halon Pull Station	Yellow / Blue	IAM	#14
Halon Abort Switch	Yellow / Blue	IAM	#14
Halon Bell	Red / Black	Signal ZAM	#14
Pre-Action Low Air Pressure	Orange / Brown	IAM	#14
Pre-Action Discharge Switch	Orange / Brown	IAM	#14
Solenoid Wiring	Red / Black	Signal ZAM	#14
Solenoid Disconnect Switch	Red / Black	Coil Module	#14
Water Flow Bell	Red / Black	Signal ZAM	#14
Water Flow Switch	Orange / Brown	IAM	#14
Valve Tamper Switch	Orange / Brown	IAM	#14
Smoke Detector	Mapnet	FACP	#18 T/S/P
Beam Detector	Yel / Blu / Wht / Vio	IAM	#14
Heat Detector	Mapnet	FACP	#18 T/S/P
Flame Detector	Yel / Blu / Wht / Vio	IAM	#14
Hood Suppression Systems	Yellow / Blue	IAM	#14
Cable Smoke Detectors (VESDA)	Yel / Blu / Wht / Vio	IAM	#14
Pull Station	Mapnet	FACP	#18 T/S/P
Duct Detector	Mapnet / Wht / Vio	FACP	#18 T/S/P - #14
ZAM (All types)	Mapnet / Wht / Vio	FACP	#18 T/S/P - #14
IAM	Mapnet	FACP	#18 T/S/P
Relays	White / Violet	Control Point	#14
120VAC Door Holders	White / Phase Color	Control Point	#12
120VAC Dampers	White / Phase Color	Control Point	#12
AHU Contactor / MCC Shutdown	Phase Color / Sw Leg	Relay	#12
AHU VFD Shutdown	Red / Red	Relay	#14 or #12
Audio Visual	Red / Black	Sync Module	#14
Visual Only	Red / Black	Sync Module	#14
Signal Module	Red / Black	Signal Circuit	#14
Ground / Bond	Green	Grounds/Bonds	#14

**Mapnet** is defined as Power Limited or Non-Power Limited Twisted Shielded #18 Pair Cable.

**Phase Color** is defined as the primary phase color used to power the controlled device.

**Sw Leg** is defined as the switch leg color used to power the controlled device.



## 2.3 EQUIPMENT

## A. FIRE ALARM CONTROL PANEL

Where shown on the plans, provide and install the Fire Alarm Control Panel called for in these specifications. Provide a Fire Alarm Control Panel compatible as a pier with a Simplex 4120 pier to pier reporting network, this includes total exchange of all analog, digital, pseudo, and control data.

1. Simplex 4120 Network Control Panel:
  - a. This system shall be used for all fire alarm speaker installations.
  - b. This system shall be used for all fire alarm fire phone installations.
  - c. This system shall be used for all addressable detection installations.
  - d. Panel shall include one, (1,) 4120 Network Communications card with two, (2,) RS-485 Hardwire Media Cards.
  - e. Panel shall include one, (1,) Network TCP/IP bridge card with two, (2,) RS-485 Hardwire Media Cards.
  - f. Panel shall include one, (1,) RS-232 card with two, (2,) open ports.
  - g. Panel shall include two, (2,) Ethernet jacks connected per section 16700.
  - h. Panel shall include one, (1,) FieldServer X-40 interface, mounted next to the panel per schematic diagram 16720-D2 at end of this section, programmed with:
    - i. Simplex 4100 protocol driver.
    - ii. BACnet TCP/IP protocol driver.
    - iii. Five thousand, (5,000) point capacity.
    - iv. All fire alarm panel monitor points including spares.
    - v. All fire alarm panel control points including spares.
    - vi. All fire alarm panel pseudo points that are in use.
    - vii. Fire alarm Network System/Detector Reset point.
    - viii. Fire alarm Network Silence point.
    - ix. Fire alarm Network Priority 2 Reset point.
2. Additional Control Panel Equipment and Capacities:
  - a. Fire alarm panels shall be provided with twenty-five, (25,) percent spare capacity installed on the following components:
    - i. Audio circuits.
    - ii. Visual circuits.
    - iii. Speaker circuits.
    - iv. Fire Phone circuits.
    - v. Addressable Detection points.
    - vi. Hard-wire Detection points.
    - vii. Auxiliary Control circuits.
    - viii. Graphic I/O points.
    - ix. Annunciator Control switches and LEDs.
  - b. Power supplies:
    - i. Shall be sized as necessary to provide all the power required in section 16720-2.3, A, 2.

- ii. And shall provide two, (2,) amps of power for each and every installed Notification Appliance Circuit, Auxiliary Control Circuit, Auxiliary Relay Zone Addressable Module, and Signal Zone Addressable Module.
    - c. Batteries:
      - i. Shall be sized as to provide twenty-four, (24,) hours of standby operation for the load handled by the power supplies.
      - ii. Shall be sized as to provide five, (5,) minutes of alarm for the load handled by the power supplies after twenty-four, (24,) hours of standby operation.
      - iii. The only acceptable batteries are listed here by manufacturer, ampacity and voltage.
        1. Eagle Pitcher:
          - a. 6.2A 12VDC.
          - b. 10A 12VDC.
          - c. 18A 12VDC.
          - d. 33A 12VDC Square case or Long case.
          - e. 50A 6VDC.
        2. Sonnenschei:
          - a. 110A 12VDC.
  3. Auxiliary Bypass Keys

Provide five (5) auxiliary bypass keys on the Fire Alarm Control Panel. Activation of these keys to be password protected. When activated, the normal alarm sequence operations of the programmed devices/control functions will not occur. Upon activation of these keys, a trouble condition will be present on the Fire Alarm Control Panel. Indicate on the Fire Alarm Control Panel one (1) trouble condition for each signal circuit/type of device/control function that is effected by the bypass.

Program the keys to accommodate bypassing the following devices/control functions (in order, from top to bottom):

    - Air Handler Unit Shut Down and Door Holder Release
    - Sprinkler System Water Flow Switches
    - Audible and Visual Signaling Devices
    - Duct Smoke Detectors
    - Elevator Recall
  4. Device Bypass Groups

Provide the Fire Alarm Control Panel with the capability of supporting separate lists of device groups whereby particular groups of devices may be bypassed and the rest of the system will remain active and operate as programmed per normal system operation. Program the groups to operate upon activation of a single point, negating the need to deactivate/reactive each individual device in the group. Provide the following groups of devices:

    - Smoke detectors by floor, in groups as designated by the Owner.
- B. NON-ADDRESSABLE PERIPHERAL DEVICES

1. Audio Visual - 75 candela units - Model #4903-9426

Provide polarized fire alarm horn/strobes that operate with 24VDC. Provide separate wire leads for in/out wiring for each leg of the associated signal (horn or strobe) circuit. Provide integral, synchronized, xenon strobe compatible with ADA requirements for the type of occupancy in which the horn/strobe devices are installed. Provide 8000 peak candela power for each strobe and make adjustable from 1 to 3 flashes per second. Synchronize all visuals to flash simultaneously.

2. Visual Only - 30 candela units - Model #4904-9174

Provide, UL Listed, entirely solid state, visual only indicating appliances comprised of a synchronized xenon flashtube, compatible with ADA requirements for the occupancy in which the devices are installed. Synchronize all visuals to flash simultaneously.

3. Speaker Visual – 75 candela units – Model #4903-9357

Provide polarized fire alarm speaker/strobe that operate with 24VDC. Provide separate wire leads for in/out wiring for each leg of the associated signal (speaker or strobe) circuit. Provide integral, synchronized, xenon strobe compatible with ADA requirements for the type of occupancy in which the speaker/strobe devices are installed. Provide 8000 peak candela power for each strobe and make adjustable from 1 to 3 flashes per second. Synchronize all visuals to flash simultaneously.

4. Sprinkler System Water flow switches - Equipment from Division 15 or existing

Monitor automatic sprinkler system water flow switches with Individual Adaptor Modules (IAMs). Provide water flow switches consisting of a cast aluminum pipe saddle housing an electromechanical device to which is attached a corrosion-free, flexible, low-density polyethylene paddle. The paddle conforms to the inside diameter of the sprinkler pipe and senses all water movements. To prevent false alarms, incorporate an adjustable time delay mechanism in the flow switch between the paddle-operated stem and the alarm initiating contacts. Provide a tapped 1/2" conduit connection. Provide a flow switch with a UL listing for the intended purpose.

5. Sprinkler System Valve Tamper Switches - Equipment from Division 15 or existing

Monitor automatic sprinkler system valve tamper switches with Individual Adaptor Modules (IAMs). Provide valve tamper switches consisting of an acid treated, cast aluminum housing with nickel plated parts to resist corrosion. Supervise the removal of the switch housing cover. Provide the switch with either one or two sets of S.P/D.T. micro switches as required. Provide a switch with a UL listing for its intended purpose.

6. Door Holders - 120VAC - Model #2088-9607 (Flush), #2088-9609 (Surface) or Model #2088-9608 (Semi-flush)

Control door holders with Zone Adaptor Modules (ZAMs). Provide magnetic door holders with an approximate holding force of 35 lbs. Provide the door portion with a stainless steel pivotal mounted armature with shock absorbing nylon bearing. Provide a door holder unit capable of being either surface, flush, semi-flush or floor mounted as required. Provide door holders with a UL listing for their intended purpose.

7. Photoelectric Projected Beam Detectors - Transmitter/Receiver Set - Model #D296

Provide photoelectric, projected beam detectors capable of being monitored by Individual Adaptor Modules (IAMs) or Zone Adaptor Modules (ZAMs). Provide photoelectric projected beam detectors with the UL #268 listing. Provide separate

transmitters/receivers capable of long range coverage of up to 328 ft (100M), and have seven (7) sensitivity settings. Incorporate automatic compensation for lens contamination. Include a normal status indicator (Green Pulsing LED), an alarm indicator (Red LED) and a trouble indicator (Amber LED) on the detector. Provide dedicated, resettable, operating power for the detectors from the Fire Alarm Control Panel. Provide 24VDC operating voltage (Nominal).

8. Fire Alarm Auxiliary Relay - Part #2088-9007

Provide one or two single pole, double throw relay switches for loads up to 120VAC. Provide a separate 24 VDC output relay with 10A, 120VAC rated contacts with a 7A in-line fuse for control of each type of equipment indicated to have relays. Provide power to this relay from the 24VDC power for the fire alarm device that controls the relay. Control this relay from duct detector auxiliary contacts or ZAM contacts.

Provide relays for interfacing the fire alarm system with the following equipment:

- air handling system motor control centers
- door holder circuits
- shunt trip circuits

Locate relays in a separate electrical outlet box (4 11/16" square x 2 1/8" deep) adjacent to the equipment/circuit served by the relay. Route circuits from controlled equipment and fire alarm device (duct detector or ZAM) into relay box. Orient relay so any 120VAC (or greater) circuit does not cross the 24VDC fire alarm circuit inside the relay box. Route ONLY 24VDC into the fire alarm device boxes.

D. ADDRESSABLE DEVICE TYPES

1. General - The system Fire Alarm Control Panel, over its two wire multi-drop channel, must be capable of communicating with the types of addressable devices specified below.

2. Addressable Sensor Bases - Model #4098-9792

Provide sensor bases containing an integral LED that will flash each time it is scanned by the Fire Alarm Control Panel (once every 4 seconds). Turn the sensor base LED "ON" when the Fire Alarm Control Panel determines that a sensor is in the alarm or a trouble condition. Sensor bases which do not provide a visible indication of an abnormal condition at the sensor location are not acceptable.

3. TrueAlarm Smoke Sensors - Model #4098-9714

Provide photoelectric type, addressable smoke sensors that communicate actual smoke chamber values to the system Fire Alarm Control Panel. Provide solid state, photoelectric type sensors containing no radioactive material. Use a pulsed infrared LED light source and be sealed against rear air flow entry for sensor operation.

Interrupt the supervisory current of the fire alarm detection loop upon removal of the detector head and cause a trouble signal at the Fire Alarm Control Panel. Provide a plug-in sensor unit which mounts to a twist-lock base.

Provide sensors with a UL #268 listing and documented as compatible with the control equipment to which they are connected. Provide sensors listed for both ceiling and wall mount applications. Provide sensors containing a magnetically actuated test switch to provide for easy alarm testing at the sensor location.

Scan each sensor by the Fire Alarm Control Panel for its type identification to prevent inadvertent substitution of another sensor type. Permit continued operation of the Fire Alarm Control Panel but initiate a "WRONG DEVICE" trouble condition until the proper type is installed or the programmed sensor type is changed.

Provide sensors with electronics immune to false alarms caused by EMI and RFI.

Provide sensors that fit into a base that is common with both the heat detector and photoelectric type detector and non-addressable bases capable of being monitored by an Zone Adaptor Module (ZAM) or Individual Addressable Module (IAM). Provide sensors compatible with other addressable detectors, addressable manual stations, and addressable Zone Adaptor Modules on the same circuit.

There will be no limit to the number of detectors, stations, or Zone Adaptor Modules, which may be activated or "in alarm" simultaneously.

4. Addressable Thermal Detector Head - Model #4090-9733

Provide UL listed, combination rate-of-rise and fixed temperature (135 F) type, automatically restorable thermal sensing heads.

Interrupt the supervisory current of the fire alarm detection loop upon removal of the heat sensor head and cause a trouble signal at the Fire Alarm Control Panel.

Provide a plug-in heat sensor unit which mounts to a twist-lock base. Provide sensors listed for both ceiling and wall mount applications.

Provide heat sensor units with a UL #268 listing and documented as compatible with the control equipment to which they are connected.

Scan each sensor by the Fire Alarm Control Panel for its type identification to prevent inadvertent substitution of another sensor type. Permit continued operation of the Fire Alarm Control Panel but initiate a "WRONG DEVICE" trouble condition until the proper type is installed or the programmed sensor type is changed.

Provide sensors with electronics immune to false alarms caused by EMI and RFI.

5. Addressable Pull Stations - Model #4099-9003

Provide double action, push-pull type, addressable pull stations containing electronics that communicate the station's status (alarm, normal) to the Fire Alarm Control Panel over two wires which also provide power to the pull station. Set the address for the device on the station itself. Provide pull stations manufactured from high impact red Lexan with raised lettering painted white with a UL listing for the devices intended purpose.

Provide pull stations with a "front" that is hinged to a back plate assembly that will mechanically latch upon operation and remain so until manually reset by opening with a key common to all pull stations. Provide pull stations with the Simplex Series "B" key locksets. Stations which use allen wrenches or special tools to reset are NOT acceptable.

Provide an addressable pull station capable of field programming its "address" location on an addressable signaling line circuit.

There will be no limit to the number of stations which may be activated or "in alarm" simultaneously.

6. Addressable Photoelectric Duct Detector - Model #4098-9756 (uses TrueAlarm Smoke Sensor Model #4098-9714), Remote Test Switch Model #2098-9806 and Sample Tube Kit Model #2098-9799.

Provide solid state, non-polarized, 24VDC, photoelectric type duct detector compatible with the Fire Alarm Control Panel that obtains its operating power from the supervisory current in the fire alarm detection loop.

Provide duct detectors that operate on the light scattering, photodiode principle. Provide an insect screen to minimize nuisance alarms. Provide duct detectors designed to ignore invisible particles or smoke densities that are below the factory set point. Provide duct detectors with sensor heads that are directly interchangeable with an ionization detector type. The 24VDC detector may be reset by actuating the Fire Alarm Control Panel reset switch.

Provide duct detectors with a mounting base with a twist-lock detecting head that is lockable. The locking feature must be field removable when not required. Provide contacts between the base and head of the bifurcated type utilizing spring type, self-wiping contacts. Interrupt the supervisory current of the fire alarm detection loop upon removal of the detector head and cause a trouble signal at the Fire Alarm Control Panel. Provide compatibility of the detector design with other normally open fire alarm detection loop devices (heat detectors, pull stations, etc.).

Provide duct detector housings capable of being alarmed by using a test switch.

Provide duct detector housings that provide access through the front cover for cleaning the detector sampling tubes.

Employ voltage and RF suppression techniques to minimize false alarms.

Install, where indicated on the plans, remote LED alarm indicators and key operated test stations. Locate test stations along foot traffic routes within the space in which the duct detector is located and mount where accessible without the use of a ladder.

7. Individual Adaptor Module (IAM) - Model #4090-9001

Use Individual Adaptor Modules for monitoring water flow switches, valve tamper switches and (if called for) non-addressable detectors.

Use IAMs for conventional 2-wire detection devices and/or contact devices monitored with Style D monitoring. These IAMs will monitor and communicate the device/zone's status (normal, alarm, trouble) to the Fire Alarm Control Panel.

Uniquely identify IAMs at the Fire Alarm Control Panel. Transmit device identification to the Fire Alarm Control Panel for processing according to the program instructions. Should an IAM become non-operational, tampered with, or removed, a discrete trouble signal, unique to the device, shall be transmitted to, and annunciated at, the Fire Alarm Control Panel.

Provide the capability of programming IAMs for their "address" location on the addressable device signaling line circuit. IAMs are to be compatible with addressable manual stations and addressable detectors on the same addressable circuit.

Supervise the IAM for all trouble conditions. Indicate the type of trouble condition (open, short, device missing/failed) at the Fire Alarm Control Panel. Should an IAM fail, it will not hinder the operation of other system devices.

8. Relay Zone Adaptor Module (ZAM) – Model #2190-9163

Use ZAMs for control of door hold opens, elevator functions during alarm conditions, control of air handling unit systems. Provide an addressable interface module for interfacing normally open, direct contact devices to an addressable signaling line circuit. Provide ZAMs capable of mounting in an outlet box (4 11/16" square x 2 1/8" deep). Include cover plates for ZAMs to allow surface or flush mounting. Provide 24VDC power to a ZAM from a separate two wire pair running from an appropriate power supply.

Provide ZAMs with two, easily replaceable, 2 amp fuses, one on each common leg of the relay. Provide each module with Style Z version wiring supervision, looping the wiring back and connecting to the module to allow continual operation of the controlled devices even if the wiring sustains a single break. These ZAMs will communicate the supervised wiring status (normal, trouble) to the Fire Alarm Control Panel and will receive a command to transfer the relay from the Fire Alarm Control Panel.

Uniquely identify ZAMs at the Fire Alarm Control Panel. Transmit device identification to the Fire Alarm Control Panel for processing according to the program instructions. Should the ZAM become non-operational, tampered with, or removed, transmit a discrete trouble signal, unique to the device, to the Fire Alarm Control Panel.

Provide the capability to program the ZAMs for their "address" location on the addressable device signaling line circuit. Provide ZAMs compatible with addressable manual stations and addressable detectors on the same addressable circuit.

Supervise the ZAM for all trouble conditions. Indicate at the Fire Alarm Control Panel the type of trouble condition (open, short, device missing/failed). Should a ZAM fail, it will not hinder the operation of other system devices.

9. Audio Visual - 75 candela units – Model #4903-9451  
(Requires Model #4009-9401 and Model #4009-9812)

Provide polarized fire alarm audio visual that operate with 24VDC. Provide separate wire leads for in/out wiring for each leg of the associated signal (audio visual) circuit. Provide integral, synchronized, xenon strobe compatible with ADA requirements for the type of occupancy in which the audio visual devices are installed. Provide 8000 peak candela power for each audio visual and make adjustable from 1 to 3 flashes per second. Synchronize all visuals to flash simultaneously. Transmit device identification to the Fire Alarm Control Panel for processing according to the program instructions. Should the Audio Visual become non-operational, tampered with, or removed, transmit a discrete trouble signal, unique to the device, to the Fire Alarm Control Panel.

10. Visual Only - 75 candela units – Model #4904-9351  
(Requires Model #4009-9401 and Model #4009-9812)

Provide, UL Listed, entirely solid state, visual only indicating appliances comprised of a synchronized xenon flashtube, compatible with ADA requirements for the occupancy in which the devices are installed. Synchronize all visuals to flash simultaneously. Transmit device identification to the Fire Alarm Control Panel for processing according to the program instructions. Should the Visual Only become non-operational, tampered with, or removed, transmit a discrete trouble signal, unique to the device, to the Fire Alarm Control Panel.

11. Speaker Visual – 75 candela units – Model #4903-9357  
(Requires Model #4009-9401 and Model #4009-9812)

Provide polarized fire alarm speaker visuals that operate with 24VDC. Provide separate wire leads for in/out wiring for each leg of the associated signal (speaker or visual) circuit. Provide integral, synchronized, xenon strobe compatible with ADA requirements for the type of occupancy in which the speaker visual devices are installed. Provide 8000 peak candela power for each speaker visual and make adjustable from 1 to 3 flashes per second. Synchronize all visuals to flash simultaneously. Transmit device identification to the Fire Alarm Control Panel for processing according to the program instructions. Should the Speaker Visual become non-operational, tampered with, or removed, transmit a discrete trouble signal, unique to the device, to the Fire Alarm Control Panel.

#### E. EQUIPMENT ENCLOSURES

Provide cabinet(s) of sufficient size to accommodate the following equipment:

- Fire Alarm Control Panels
- Fire Alarm Control Panel associated electronic components
- Remote Annunciators

Provide doors, with locks and MEDECO cylinders, for all cabinets. Provide cabinet covers (inside cabinet doors) for all cabinets.

For the Fire Alarm Control Panel cabinet, provide openings in the cabinet cover necessary to manipulate/access all the Fire Alarm Control Panel controls and a transparent door panel to allow freedom from tampering and full view of the various lights and controls. For all other cabinets, provide covered openings in the cabinet cover (for potential future modifications) and solid doors.

### PART 3 - EXECUTION

#### 3.1 INSTALLATION

- A. Provide and install the system in accordance with the plans and specifications, all applicable codes and the manufacturer's recommendations.
- B. Install all wiring in strict compliance with all the provisions of NEC - Article 760 A and C, Power-Limited Fire Protective Signaling Circuits or if required may be reclassified as non-power limited and wired in accordance with NEC-Article 760 A and B. Upon completion, the contractor shall so certify in writing to the Owner. Adhere to all other applicable NEC wiring methods.
- C. Install wiring that is approved by the fire alarm equipment manufacturer.
- D. Install Class A (Style 6 Signaling Line Circuit as defined by NFPA-72) communications.
- E. Install all Class A circuits such that the outgoing and return conductors, exiting from and returning to the control unit respectively, are routed separately. Do not run the outgoing and return circuit conductors in the same cable assembly (multiconductor cable), enclosure or raceway. Separate the field outgoing and return wiring by at least 6 feet or by 1-hour fire rated construction. Outgoing and return wiring does not have to be separated where:
  - 1. The circuit is installed underground
  - 2. The circuit encased in 2 hour fire resistive construction
  - 3. The circuit makes a single drop to an individual device within 10 feet of the loop

Exceptions to the 6 foot/1-hour fire rated construction separation of outgoing and returning conductors will be considered by the Owner in unique device location circumstances. Request exceptions to this requirement in writing to the Owner.



- F. Individually configure circuits on site to provide either alarm/trouble operation, alarm only, trouble only, current limited alarm, no alarm, normally closed device monitoring, a non-latching circuit or a alarm verification circuit, to accommodate and facilitate job site changes.
- G. Individually configure horn circuits on site to provide, upon activation, a fast march time, slow march time, temporal code, PNIS code or a master code until silenced upon any output circuit, to accommodate and facilitate job site changes. The PNIS coded pulse on and off time may be selectable on site to provide 16 different duty cycles between 1/4 second and 5 seconds.
- H. Provide separate circuits for the audible and visual portions of all alarm indicating appliances.
- I. Arrange wiring of the circuits for strobe devices such that adjacent strobe devices are on separate circuits. Limit the number of strobe devices on any one circuit to 12 devices.
- J. Provide a manufacturer's authorized representative on-site for supervision of the installation.
- K. Install all devices and fire alarm equipment in accordance with the current NEC, the manufacturer's recommendations, NFPA 72, the plans, these specifications and the requirements outlined below. Notify the Owner if the plans indicate (or field conditions necessitate) locating/positioning any devices contrary to the manufacturer's recommendations, NFPA 72, or the requirements outlined below.
  - 1. Locate smoke detectors as follows:
    - No closer than 3 feet from any air supply diffuser.
    - No farther than 15 feet from a wall or end of a corridor.
    - No farther than 30 feet between detectors.
  - 2. Locate manual pull stations such that the operable portion of the pull station (the center of the handle) located at 48" above the finished floor level.
  - 3. Locate visual only devices such that the device is 80 inches above the finished floor level OR 6" below the finished ceiling level, whichever is lower. Measure height above/below the floor/ceiling to the center of the device.
  - 4. Locate audio/visual devices such that the device is 80 inches above the finished floor level or 6" below the finished ceiling level, whichever is lower. Measure height above floor/below ceiling to the center of the visual component of the device.
  - 5. Locate test switches for duct smoke detectors such that the device is adjacent to a traveled access aisle/path near the air handler served by the test switch and positioned not more than 48" above the finished floor level. Measure height above the floor to the center of the switch.
  - 6. Locate Fire Alarm equipment enclosures such that the center of the display portion of the panel is 60" above the finished floor.
- L. Elevator Interface with Fire Alarm System – to facilitate elevator recall, install smoke detectors at each elevator lobby, in the elevator equipment room, and at the top of the elevator shaft as indicated on the plans. This interface shall be provided regardless of the existing elevator operation. Program the Fire Alarm Control Panel to use these devices to perform the elevator recall function as outlined in Section 1.3.K.2 of these specifications.

Connect the fire alarm system to the elevator controls for elevator recall with ZAMs. Pull three wires (a common, a normally open, and a normally closed) from each elevator recall ZAM into the elevator controls cabinet. If elevator equipment does not facilitate the actual recall function all preparations and installations shall be made to accommodate these functions.

Where there are sprinkler heads in the elevator shaft, elevator pit, or elevator equipment room, install heat detectors, as indicated on the plans, within 2 feet (measured horizontally) of each sprinkler head. For these specific locations, provide heat detectors with a lower temperature rating and higher sensitivity (response time index), as compared to the sprinkler heads.

Provide an auxiliary alarm relay to interlock with the elevator power shut-off/shunt trip unit.

Provide an IAM and a Fire Alarm Auxiliary Relay to monitor the presence of shunt trip power.

Provide a shunt trip circuit breaker on the elevator equipment power circuit in the elevator equipment room. Extend the interlock conductors from the Fire Alarm Control Panel to the new shunt trip circuit breaker.

Provide control ZAM or Relay IAM to activate car fire alarm light if an alarm has been detected in the machine room or hoistway.

M. Air Handler Motor Control Interface with Fire Alarm System

1. Provide a single pole, double throw relay switch for loads up to 120VAC for each air handling unit's motor control center that is equipped with duct smoke detection. Provide a separate 24 VDC output relay with 10A, 120VAC rated contacts with a 7A in-line fuse for control of each type of equipment shown. Provide power to this relay from the 24VDC power to the relay ZAM. Control this relay from the type 2 control ZAM contacts. Locate relays in a separate electrical outlet box (4 11/16" square x 2 1/8" deep) adjacent to the air handling unit motor control center. Route circuits from motor controls and duct detector relay box. Route ONLY 24VDC into the control ZAM box.

N. Door Holder Control

1. Provide ZAMs for the fire alarm system's control of door holders.
2. Provide a double pole, double throw relay capable of switching for loads up to 120VAC for each door holder circuit.
3. Locate relay in a separate electrical box (4" square standard) adjacent to the ZAM box. Route 120VAC circuits from door holders and 24VDC circuit from ZAM into relay box. Orient relay so 120VAC circuit does not cross the 24VDC circuit inside the relay box. Route ONLY 24VDC into the ZAM box.
4. Provide power to relay from the 24VDC power to the ZAM. Provide the output relay with 10A, 120VAC rated contacts with a 7 Amp in-line fuse for control of each door holder circuit. Control this relay from the ZAM contacts.
5. Provide door holder control ZAM with Style Z version wiring supervision, looping the wiring back and connecting to the module to allow continual operation of the controlled devices even if the wiring sustains a single break. Communicate the ZAM's supervised wiring status (normal, trouble) to the Fire Alarm Control Panel and receive commands to transfer the relay from the Fire Alarm Control Panel.

- O. After the completion of the installation, clean all dirt and debris from the inside and the outside of the fire alarm equipment.

3.3 ACCEPTANCE INSPECTION AND TESTING

- A. Perform testing during hours approved by the Owner.

- B. Fully test every function, every device, and the operation of the completed fire alarm system in the presence of the Owner and the equipment manufacturer's representative.
- C. During the testing outlined above, the Owner will direct the contractor and equipment manufacturer's representative as to the Custom Labels to be programmed into the fire alarm system for identification of each device. This process will involve the contractor inspecting and activating each device in the presence of the owner's representative, the manufacturer's representative noting the Custom Label designation as directed by the Owner and programming this information into the Fire Alarm Control Panel.
- D. Certify, in writing, to the Owner that the fire alarm system is fully functional at the completion of the test. In addition to this written certification, provide the owner with a print out and a computer disc of the Fire Alarm Control Panel's programming documentation.
- E. Initiate, upon written approval from the Owner, a 5 calendar day trial period of the fire alarm system under full operational conditions. All functions of the fire alarm system must be operational during this trial period. The system must function for the entire 5 day period without failure, molestation, or operator input (other than that required for normal system operation - such as acknowledging an alarm, silencing and resetting the system, etc).
- F. Should the system not complete this 5 day trial, perform appropriate repairs and retesting in accordance with NFPA 72 and these specifications. Provide a new written certification of the system's operation and revised Fire Alarm Control Panel programming documentation (hard copy and computer disc) to the University. Then initiate, upon written approval from the owner, another 5 day trial. The system must complete a successful 5 day trial before acceptance testing by the Authority Having Jurisdiction will be permitted.
- G. Fully test the system, after the completion of a successful 5 day trial, in the presence of, and as directed by, the Authority Having Jurisdiction/State Fire Marshall's representative and the Owner. Should the system fail this test, make all repairs and upon receipt by the Owner of notification in writing by the contractor of compliance with the required repairs, another 5 day trial period shall be performed.

#### 3.4 LABELING/MARKING

- A. Spray paint red all fire alarm pull and junction boxes and associated covers that will be located in concealed spaces prior to their installation.
- B. Identify the fire alarm system wiring on the pull or junction box cover by printing "FA" with an indelible felt tip pen. Print the identification neatly and legibly.
- C. Maintain wiring color code as indicated in 2.2.A and Section 16127 of these specifications throughout the installation.
- D. Maintain label tags on all wiring at junction points, per these specifications and 1996 NEC Article 760-10.
- E. Mark, with an indelible felt tip pen, the panel box and circuit number on the junction and pull boxes covers of all non-fire alarm wiring connected to the fire alarm system. Print the number of the panel box and circuit number neatly and legibly.
- F. Mark each fire alarm device with its MAPNET circuit and device number as indicated below with an indelible felt tip pen. Print the MAPNET circuit and device number neatly and legibly.
  - Pull stations - On the inside of the pull station face plate, visible when pull station opened with key.
  - ZAMs - On cover of ZAM box. (Include ZAM function, i.e., shunt trip, air handler shut down, etc.)

- IAMs - On the IAM body.
  - Duct Detectors - On the duct detector housing
- G. Mark each fire alarm smoke detector and heat detector with it's MAPNET circuit and device number as indicated below with Kroy (or equal) self adhesive tape with minimum 3/16" high black text. Cover identification text on smoke and heat detectors with Highsmith (or equal) pre-cut, 4 mil, non-glare, self-adhesive vinyl label protectors (item number L97-16140). Locate identification tape on detector base.

### 3.5 SPARE PARTS

- A. Provide the following quantities of spare parts to the owner upon completion of the project. Provide spare parts in their original factory packaging with all associated installation and product data literature.
1. Horn/Strobes- 10% of installed number or 5 devices (whichever is greater)
  2. Strobes- 10% of installed number or 5 devices (whichever is greater)
  3. Pull Stations- 2 devices
  4. Smoke Sensor Heads- 10% of installed number or 5 devices (whichever is greater)
  5. Heat Detector Heads- 10% of installed number or 5 devices (whichever is greater)
  6. Addressable Bases- 10% of installed number or 5 devices (whichever is greater)
  7. Duct Detector Housings- 1 device
  8. Duct Detector Test Switches- 2 devices
  9. Door Holders- 2 devices
  10. IAMs- 2 devices
  11. ZAMs- 2 devices

LEGEND

- ① PRIMARY FLOOR ZAM MOUNTED ON 4 11/16" BOX. SEE "CONTROL ZAM FOR ELEVATOR SHUNT" DETAIL ON DRAWING EB.08.
- ② ALTERNATE FLOOR ZAM MOUNTED ON 4 11/16" BOX. SEE "CONTROL ZAM FOR ELEVATOR ALT RECALL" DETAIL ON DRAWING EB.06.
- ③ 4 11/16" BOX FOR SHUNT TRIP ZAM AND MONITOR IAM.
- ④ FIRE ALARM SHUNT TRIP ZAM TO ACTIVATE CONTROL RELAY.
- ⑤ FIRE ALARM IAM TO MONITOR POWER STATUS.
- ⑥ 4 11/16" BOX FOR CONTROL AND MONITOR RELAYS.
- ⑦ CONTROL RELAY TO ACTIVATE SHUNT TRIP DEVICE IN ELEVATOR CIRCUIT BREAKER AND LOCAL STATUS LIGHT. SEE "CONTROL ZAM FOR ELEVATOR SHUNT" DETAIL ON DRAWING EB.08.
- ⑧ MONITOR RELAY TO REPORT TO FIRE ALARM SYSTEM. SEE "CONTROL ZAM FOR ELEVATOR SHUNT" DETAIL ON DRAWING EB.08.
- ⑨ 4 11/16" BOX FOR NEON STATUS LIGHTS. GREEN FOR "SHUNT TRIP POWER AVAILABLE" AND RED FOR "ELEVATOR SHUNT TRIP ACTIVATED". MOUNT LIGHTS ON STAINLESS STEEL COVER AND LABEL. IF GREEN LIGHT IS OFF POWER WILL NOT BE AVAILABLE TO OPERATE SHUNT TRIP. IF RED LIGHT IS ON SHUNT TRIP IS ACTIVATED.
- ⑩ SHUNT TRIP CIRCUIT BREAKER. SEE DRAWING ES.02 FOR SIZE.
- ⑪ HAT FLASH ZAM MOUNTED ON 4 11/16" SEE "CONTROL ZAM FOR ELEVATOR SHUNT" DETAIL ON DRAWING EB.08
- ⑫ GENERATED R/VN ZAM MOUNTED ON 4 11/16" SEE "CONTROL ZAM FOR ELEVATOR SHUNT" DETAIL ON DRAWING EB.09

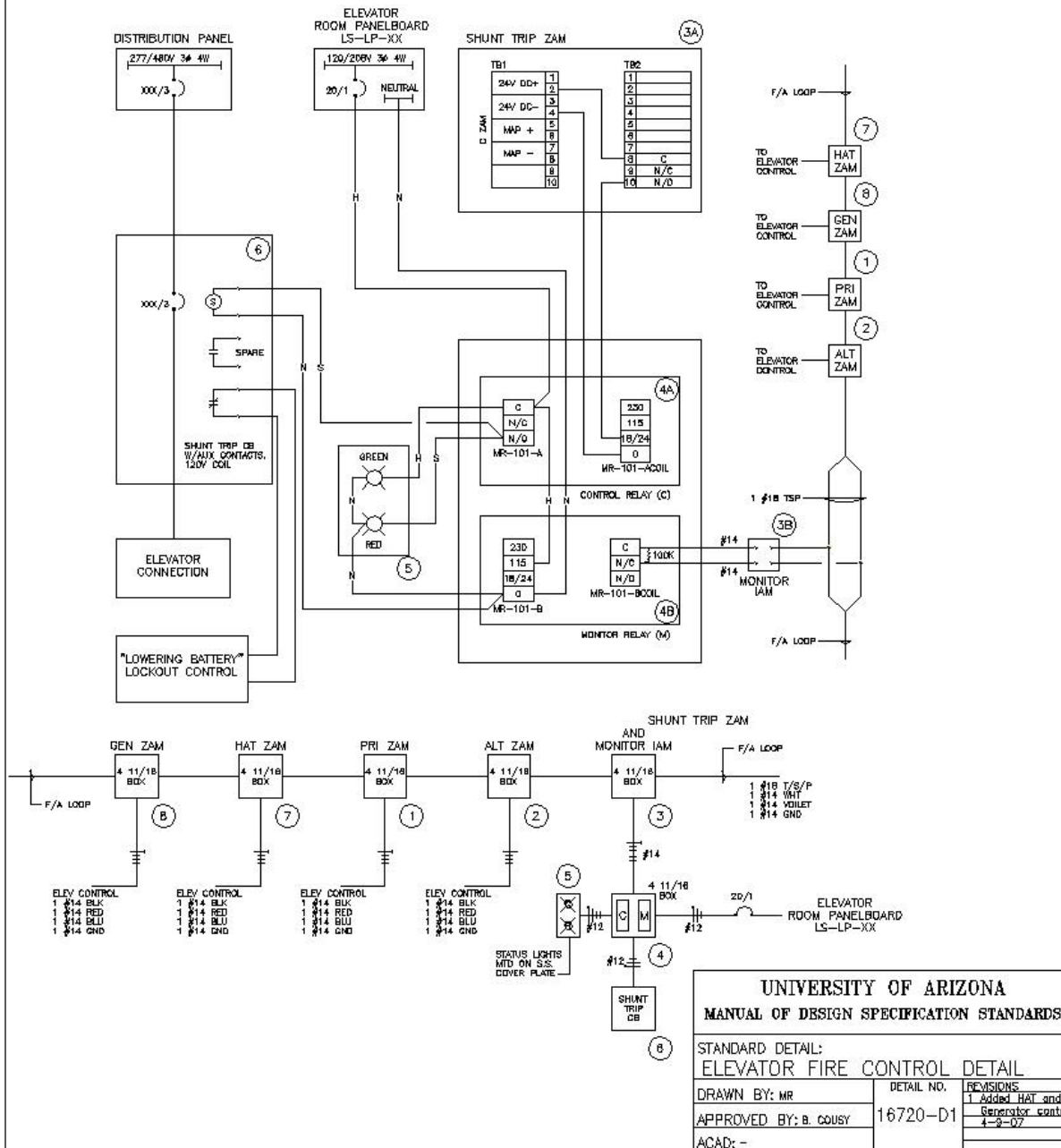

**UNIVERSITY OF ARIZONA**  
**MANUAL OF DESIGN SPECIFICATION STANDARDS**

STANDARD DETAIL:  
**ELEVATOR FIRE CONTROL DETAIL**

DRAWN BY: MR	DETAIL NO. 16720-D1	REVISIONS 1 Added HAT and Generator control 4-9-07
APPROVED BY: B. COUSY		
ACAD: -		

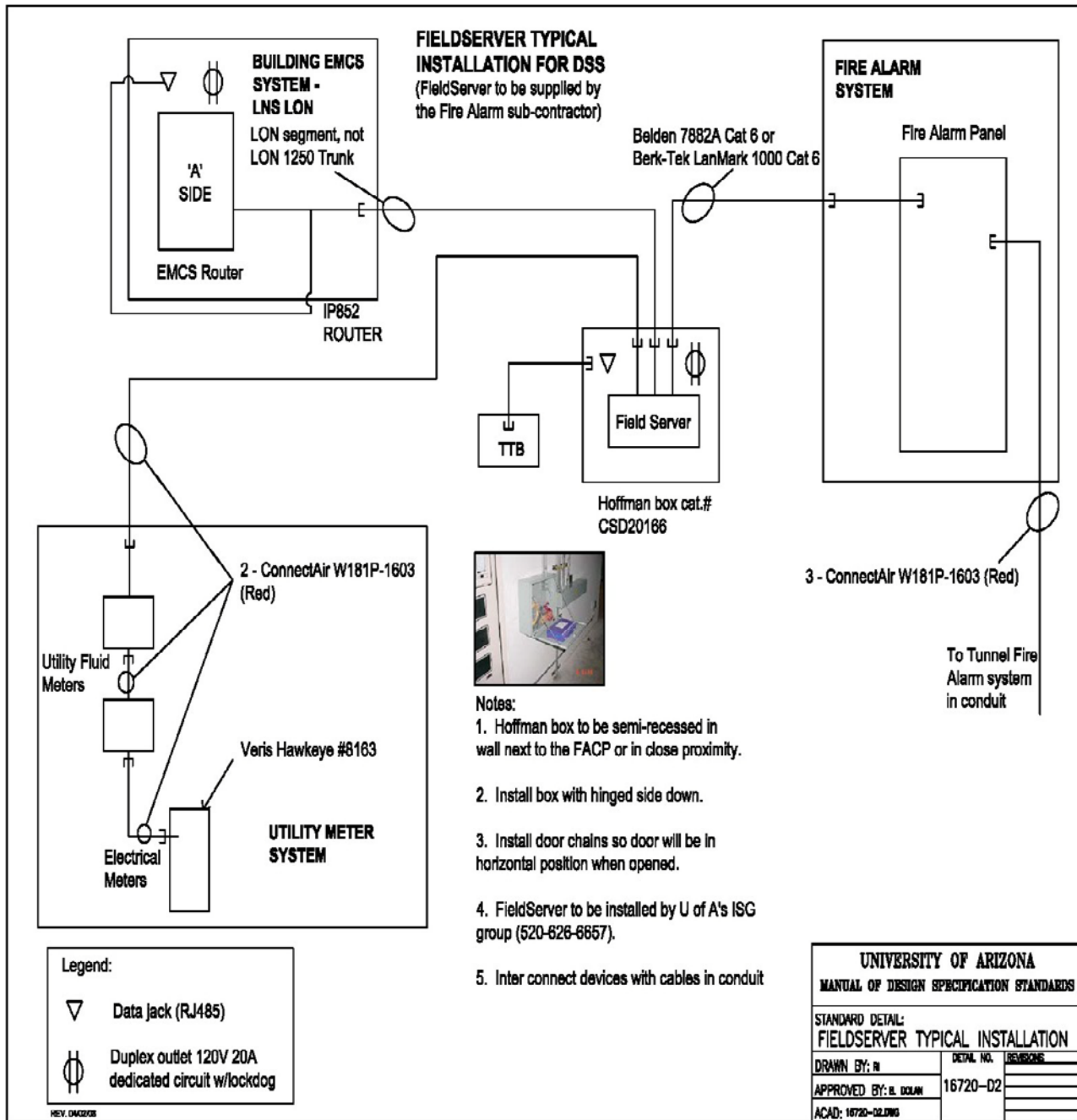

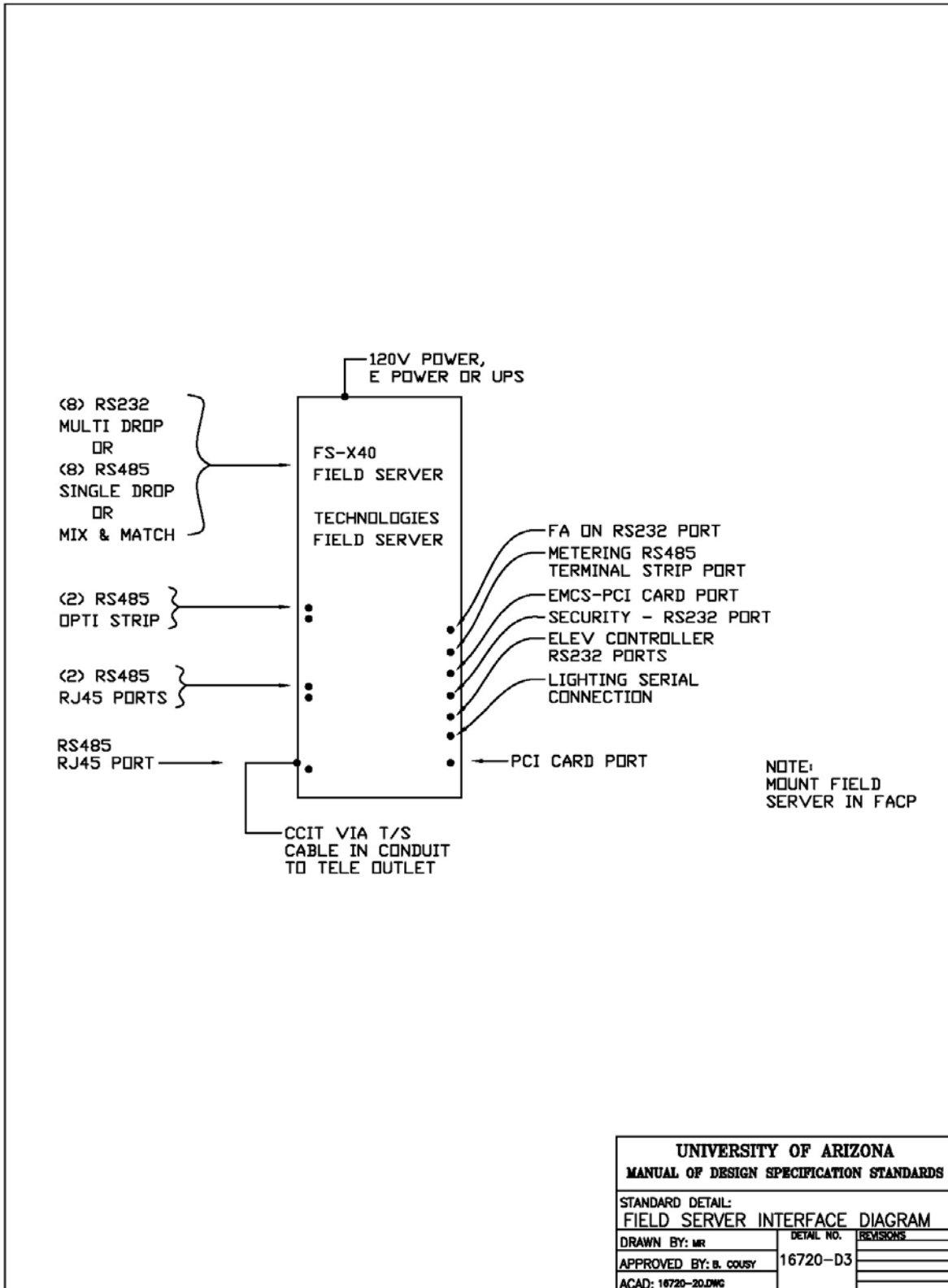

End of Appendix Section 16720